



C A F É

DISTINCT BY DESIGN

# Owner's Manual





DISTINCT BY DESIGN™

## Owner's Manual

# Direct Air Convection Built-In Electric Wall Oven

Models: CTS90DM, CTS90DP (30" Single Oven)  
CTD90DM, CTD90DP (30" Double Oven)

### Contents

<b>Safety Information</b> .....	3	<b>Care And Cleaning</b>	
<b>Using the Oven</b>		Cleaning The Oven – Exterior .....	20
Oven Controls .....	6	Cleaning The Oven – Interior .....	21
Double Oven .....	7	Probe .....	22
Settings .....	7	Oven Light .....	22
Sabbath .....	9	Oven Door .....	23
Oven Racks .....	10	<b>Troubleshooting Tips</b> .....	24
Aluminum Foil and Oven Liners .....	12	<b>Limited Warranty</b> .....	26
Cookware .....	12	<b>Accessories</b> .....	27
Cooking Modes .....	13	<b>Consumer Support</b> .....	28
Probe .....	15		
Cooking Guide .....	16		
Air Fry Guide .....	18		
Dehydrating Guide .....	19		

Write the model and serial numbers here:

Model # \_\_\_\_\_

Serial # \_\_\_\_\_

You can find them on a label on the side trim or on the front of the (lower) oven behind the oven door.

### Español

Para consultar una version en español de este manual de instrucciones, visite nuestro sitio de internet [cafeappliances.com](http://cafeappliances.com).

## THANK YOU FOR MAKING CAFÉ A PART OF YOUR HOME.

---

We take pride in the craftsmanship, innovation and design that goes into every Café product, and we think you will too. Among other things, registration of your appliance ensures that we can deliver important product information and warranty details when you need them.

Register your Café appliance now online. Helpful websites are available in the Consumer Support section of this Owner's Manual. You may also mail in the pre-printed registration card included in the packing material.

**C A F É**

---

DISTINCT BY DESIGN™

# IMPORTANT SAFETY INFORMATION

## READ ALL INSTRUCTIONS BEFORE USING THE APPLIANCE

**▲WARNING** Read all safety instructions before using the product. Failure to follow these instructions may result in fire, electrical shock, serious injury or death.

### ▲WARNING GENERAL SAFETY INSTRUCTIONS

- Use this appliance only for its intended purpose as described in this Owner's Manual.
- Be sure your appliance is properly installed and grounded by a qualified installer in accordance with the provided installation instructions.
- Do not attempt to repair or replace any part of your oven unless it is specifically recommended in this manual. All other servicing should be performed by a qualified technician.
- Before performing any service, disconnect the power supply at the household distribution panel by removing the fuse or switching off the circuit breaker.
- Do not leave children alone—children should not be left alone or unattended in an area where an appliance is in use. They should never be allowed to climb, sit or stand on any part of the appliance.
- **▲CAUTION** Do not store items of interest to children in cabinets above an oven - children climbing on the oven to reach items could be seriously injured.
- Use only dry pot holders—moist or damp pot holders on hot surfaces may result in burns from steam. Do not let pot holders touch hot heating elements. Do not use a towel or other bulky cloth in place of pot holders.
- Never use your appliance for warming or heating the room.
- Do not touch the heating elements or the interior surface of the oven. These surfaces may be hot enough to burn even though they are dark in color. During and after use, do not touch, or let clothing or other flammable materials contact any interior area of the oven; allow sufficient time for cooling first. Other surfaces of the appliance may become hot enough to cause burns. Potentially hot surfaces include the oven vent opening, surfaces near the opening and crevices around the oven door.
- Do not heat unopened food containers. Pressure could build up and the container could burst, causing an injury.
- Do not use any type of foil or liner to cover the oven bottom or anywhere in the oven, except as described in this manual. Oven liners can trap heat or melt, resulting in damage to the product and risk of shock, smoke or fire.
- Avoid scratching or impacting glass doors or control panels. Doing so may lead to glass breakage. Do not cook on a product with broken glass. Shock, fire or cuts may occur.
- Cook meat and poultry thoroughly—meat to at least an internal temperature of 160°F and poultry to at least an internal temperature of 180°F. Cooking to these temperatures usually protects against foodborne illness.

### ▲WARNING KEEP FLAMMABLE MATERIALS AWAY FROM THE OVEN

Failure to do so may result in fire or personal injury.

- Do not store or use flammable materials in or near an oven, including paper, plastic, pot holders, linens, wall coverings, curtains, drapes and gasoline or other flammable vapors and liquids.
- Never wear loose-fitting or hanging garments while using the appliance. These garments may ignite if they contact hot surfaces, causing severe burns.
- Do not let cooking grease or other flammable materials accumulate in or near the oven. Grease in the oven or near the oven may ignite.
- **Remote Operation** - This appliance is configurable to allow remote operation at any time. Do not store any flammable materials or temperature sensitive items inside of the appliance.

## READ AND SAVE THESE INSTRUCTIONS

# IMPORTANT SAFETY INFORMATION

## READ ALL INSTRUCTIONS BEFORE USING THE APPLIANCE

### **▲WARNING** IN THE EVENT OF A FIRE, TAKE THE FOLLOWING STEPS TO PREVENT INJURY AND FIRE SPREADING

- Do not use water on grease fires. Never pick up a flaming pan.
- If there is a fire in the oven during baking, smother the fire by closing the oven door and turning the oven off or by using a multi-purpose dry chemical or foam-type fire extinguisher.
- If there is a fire in the oven during self-clean, turn the oven off and wait for the fire to go out. Do not force the door open. Introduction of fresh air at self-clean temperatures may lead to a burst of flame from the oven. Failure to follow this instruction may result in severe burns.

### **▲WARNING** OVEN SAFETY INSTRUCTIONS

- Stand away from the oven when opening the oven door. Hot air or steam which escapes can cause burns to hands, face and/or eyes.
- Keep the oven vent unobstructed.
- Keep the oven free from grease buildup. Grease in the oven may ignite.
- Place oven racks in desired location while oven is cool. If rack must be moved while oven is hot, do not let pot holder contact hot heating element in oven.
- When using cooking or roasting bags in the oven, follow the manufacturer's directions.
- Pulling out the standard racks to their stop-locks or the extension rack to its fully open position is a convenience in lifting heavy foods. It is also a precaution against burns from touching hot surfaces of the door or oven walls.
- Do not leave items such as paper, cooking utensils or food in the oven when not in use. Items stored in an oven can ignite.
- Never place cooking utensils, pizza or baking stones, or any type of foil or liner on the oven floor. These items can trap heat or melt, resulting in damage to the product and risk of shock, smoke or fire.

### **▲WARNING** SELF-CLEANING OVEN SAFETY INSTRUCTIONS

The self-cleaning feature operates the oven at temperatures high enough to burn away food soils in the oven. Follow these instructions for safe operation.

- Do not touch oven surfaces during self-clean operation. Keep children away from the oven during self-cleaning. Failure to follow these instructions may cause burns.
- Before self-cleaning the oven, remove shiny silver colored oven racks (on some models), the probe, any aluminum foil, and any broiler pan, grid, and other cookware. Only porcelain coated oven racks may be left in the oven.
- Before operating the self-clean cycle, wipe grease and food soils from the oven. Excessive amount of grease may ignite, leading to smoke damage to your home.

## READ AND SAVE THESE INSTRUCTIONS

# IMPORTANT SAFETY INFORMATION

## READ ALL INSTRUCTIONS BEFORE USING THE APPLIANCE

### **▲WARNING** SELF-CLEANING OVEN SAFETY INSTRUCTIONS (Cont.)

- If the self-cleaning mode malfunctions, turn the oven off and disconnect the power supply. Have it serviced by a qualified technician.
- Do not clean the door gasket. The door gasket is essential for a good seal. Care should be taken not to rub, damage or move the gasket.
- Do not use a protective coating to line the oven and do not use commercial oven cleaner unless certified for use in a self-cleaning oven.

The remote enable equipment installed on this oven has been tested and found to comply with the limits for a Class B digital device, pursuant to part 15 of the FCC Rules. These limits are designed to:

**(a)** provide reasonable protection against harmful interference in a residential installation. This equipment generates, uses and can radiate radio frequency energy and, if not installed and used in accordance with the instructions, may cause harmful interference to radio communications. However, there is no guarantee that interference will not occur in a particular installation. If this equipment does cause harmful interference to radio or television reception, which can be determined by turning the equipment off and on, the user is encouraged to try to correct the interference by one or more of the following measures:

- Reorient or relocate the receiving antenna.
- Increase the separation between the equipment and receiver.
- Connect the equipment into an outlet on a circuit different from that to which the receiver is connected.
- Consult the dealer or an experienced radio/TV technician for help.

**(b)** accept any interference received, including interference that may cause undesired operation of the device.

**Note** that any changes or modifications to the wireless communication device installed on this oven that are not expressly approved by the manufacturer could void the user's authority to operate the equipment.

### How to Remove Protective Shipping Film and Packaging Tape

Carefully grasp a corner of the protective shipping film with your fingers and slowly peel it from the appliance surface. Do not use any sharp items to remove the film. Remove all of the film before using the appliance for the first time.

To assure no damage is done to the finish of the product, the safest way to remove the adhesive from packaging tape on new appliances is an application of a household liquid dishwashing detergent. Apply with a soft cloth and allow to soak.

**NOTE:** The adhesive must be removed from all parts. It cannot be removed if it is baked on.

**NOTE:** Some cooking functions and features are not available until after you WiFi connect your new oven to your local home wireless network. Please follow the instructions on the oven control and the WiFi & Remote Enable section of this guide. This provides capability to use SmartHQ app functions and ensures that the oven has the latest software.

## READ AND SAVE THESE INSTRUCTIONS

# Oven Controls

Control graphics are representative; your oven may have alternate graphic appearances.

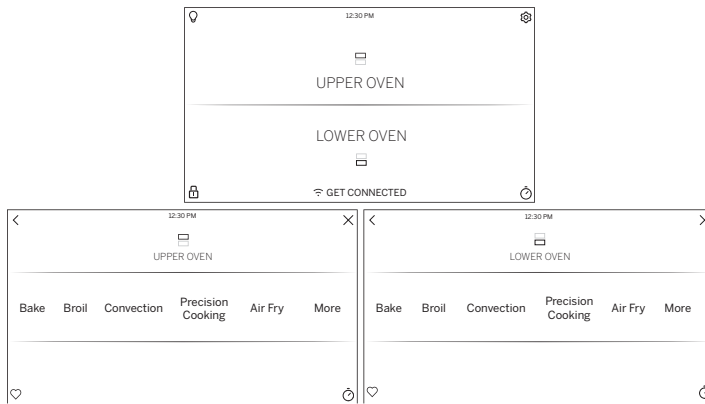

Double Wall Oven Main Menus

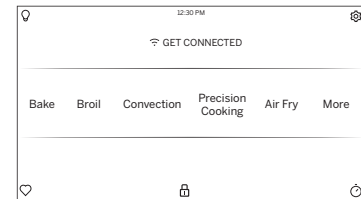

Single Wall Oven Main Menu

## Upper Oven and Lower Oven

When using a double oven you can set separate modes in each oven. The selected oven will appear above the cooking modes. **NOTE:** If using a single oven, there will not be an oven selection.

### Bake

This option allows the user to access the traditional bake mode.

### Broil

Broil can be selected to access Broil Low and Broil High. See the Cooking Modes section for more information.

### Convection

This option allows you to utilize the convection system to cook in a variety of modes. See the Cooking Modes section for more information.

### Precision Cooking

Precision Cooking is a suite of customized cooking cycles that have been designed for specific foods. The display will guide you through setting the oven and food appropriately for the cycle selected. Precision cooking cycles vary based on food type; see the Cooking Modes section for more detailed information.

### Air Fry

This allows the user to access the Air Fry cooking mode. See the Cooking Modes section for more information.

### More

Select this option to access the Dehydrate, Proof, Warm, Self Clean, and Steam Clean options.



### Oven Light

To turn on or off the oven cavity lights, press the . Both cavity lights will be illuminated if using a double oven.



### Settings

Press the  to access the Settings. See the Settings section for more information.

## Favorite

This option allows the user to save their favorite cycles for easy access in the future. After selecting a cooking mode and setting the temperature and any timers, press the  to save it as a favorite for future use. After saving a cycle, press the  on the main menu to quickly access the saved mode.

## Kitchen Timer

This feature works as a countdown timer. Press the , select the amount of time for the timer to operate, and press **Set**. The oven will continue to operate once the timer countdown is complete. To turn off the timer, select the  and press **Cancel**.

## Cook Time

This function counts down cooking time and turns off the oven when the cooking time is complete. Press the  during a cycle, select the amount of cooking time, and press **Start**. This can only be used in Bake, Convection Bake, Convection Roast, and Air Fry modes.

## Delay Time

This feature delays the start time for an oven cycle. Use this feature to set a time when you want the oven to start. Select a cycle, then press the . Select **Delay Time** to set the time of day for the oven to turn on and press **Set**. A cook time can also be programmed if desired.

## Wi-Fi & Remote Enable

Press  GET CONNECTED to connect your oven to Wi-Fi. This option allows you to download content to your oven and control it remotely. The oven must be connected to Wi-Fi before Remote Enable can be activated. For instructions on how to connect your oven, see the Wi-Fi Connect/Remote Enable section under Settings in this manual.

# Double Oven

When using both cavities to cook, the control will allow you to switch back and forth between the upper and lower oven to review the cycle selection for each. When viewing the cooking mode screen you can access the alternate cavity by pressing on the banner at the top or bottom of the screen.

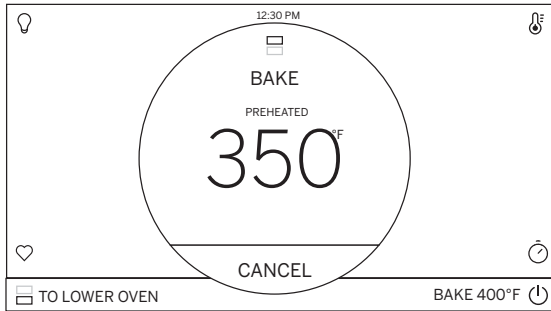

Upper Oven Bake Cycle



Lower Oven Bake Cycle

## Settings

There are numerous settings that are accessed by pressing  in the top right corner of the main screen.

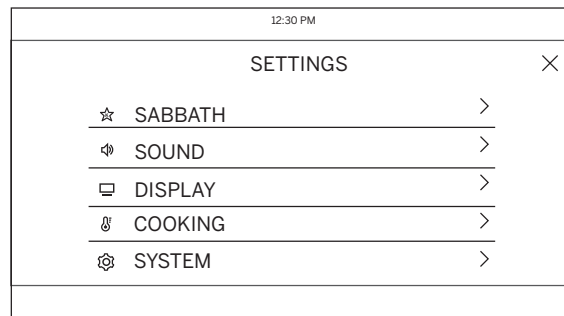
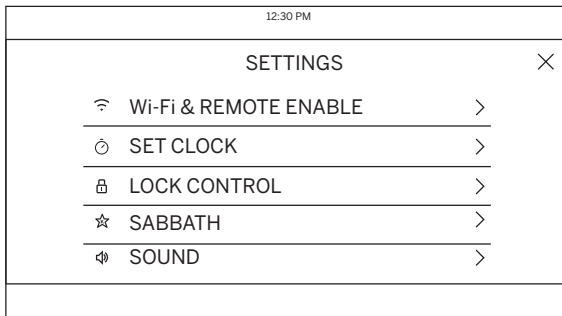

Slide up and down to access all the settings

### Wi-Fi & Remote Enable

This appliance is configurable to allow remote operation at any time. Do not store any flammable materials or temperature sensitive items inside. By using the Wi-Fi Connect feature, you will be able to control essential oven operations such as temperature settings, timers and cooking modes using your smartphone or tablet.\* Select the  then **Wi-Fi & Remote Enable** - follow the instructions on your oven display and phone app. It is necessary to turn on Wi-Fi before using Remote Enable on your oven.

#### Connecting your Wi-Fi Connect Enabled oven

1. Have your smart phone or tablet ready with the ability to access the internet and download the SmartHQ app.
2. You will need to know the password of your home Wi-Fi router. Have this password ready while you are setting up your Café oven.
3. On your smart phone or tablet, visit [cafeappliances.com/connect](http://cafeappliances.com/connect) to learn more about connected appliance features and to download the app to connect to your oven.

4. Follow the onscreen instructions in the app to connect your Café oven. When connected, your oven should show that it is connected to your home Wi-Fi network.
5. If there are issues connecting wirelessly to your oven, visit [cafeappliances.com](http://cafeappliances.com) for assistance regarding oven wireless connectivity.

To connect additional smart devices, repeat steps 3 and 4.

#### Remote Starting your Oven

To be able to start the oven remotely once connected to Wi-Fi, press **Remote Enable** on the main menu or access **Wi-Fi & Remote Enable** in the settings menu and turn Remote Enable on. The oven can now be started remotely using a connected device. The  icon must be active to start the oven remotely. To disconnect your phone from Remote Enable, access the **Wi-Fi & Remote Enable** settings and turn Remote Enable off.

**NOTE:** Foods that spoil easily—such as milk, eggs, fish, stuffings, poultry and pork—should not be allowed to sit for more than 1 hour before or after cooking. Room temperature promotes the growth of harmful bacteria. Be sure that the oven light is off because heat from the bulb will speed harmful bacteria growth.

\* Compatible Apple or Android devices and home Wi-Fi network required.



## Settings (Cont.)

There are numerous settings that are accessed by pressing  in the top right corner of the main screen.

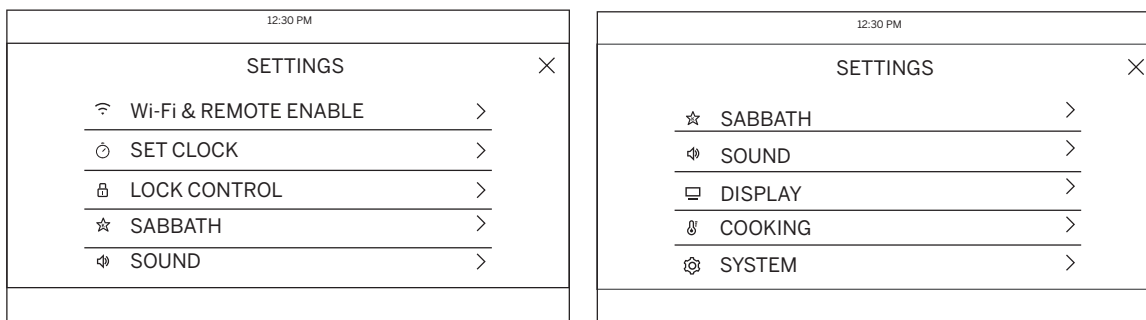

Slide up and down to access all the settings

### Set Clock

This feature allows you to set the clock and specifies how the time of day will be displayed. Options are for a standard 12-hour clock with AM and PM selections or 24-hour military time display.

### Lock Control

Select this option in order to lock the LCD from any undesired screen selections. To unlock the screen, press  and press **Unlock** on the next screen.

### Sabbath

Sabbath mode disables the oven lights (the oven light will not turn on when the door is opened), all sounds (the control will not beep when the screen is pressed), Convection modes, Broil modes, Warm, Proof, and all time functions. Sabbath mode can only be used with traditional Bake. This feature conforms to the Star-K Jewish Sabbath requirements. Please reference the Sabbath Mode section for more information.

### Sound

This setting screen allows you to change the volume, the end of cycle tone, and turn on or off the touch sound.

### Display

This screen shows the options for brightness, clock off, energy saver, and screen time out. Clock off will remove the clock from the display when the screen is inactive, but it will be shown after pressing the screen. The screen can be set to never time out or it can be set to shut off after 1, 5, or 10 minutes.

### Cooking

- The oven is set to Fahrenheit, however, in this setting the cooking unit can be changed to Celsius.
- Auto Recipe Conversion can be turned on in order to automatically reduce the programmed cooking temperature for Convection Bake or Convection Bake Multi. Note that this will only reduce the cooking temperature, not the baking time.
- When the 12 Hour Shut Off option is turned on, it will automatically shut off the oven after 12 hours of continuous use.
- Adjust Temperature allows the oven temperature to be adjusted up to 35°F hotter or down to 35°F cooler. Use this feature if you believe your oven temperature is too hot or cold and wish to change it. For double ovens, the upper and lower oven temperatures are adjusted separately. Do not use thermometers, such as those found in grocery stores, to check the temperature setting of your oven. These thermometers may vary 20–40 degrees.

### System

This screen allows you to clear your saved user data and shows the current software version.

## Oven Door Camera

The **Oven Door Camera** allows for remote viewing of the center of the oven cavity using the SmartHQ app. Download the latest SmartHQ app and follow instructions in the app to connect your range. From the app's home page, select your range, then tap on the camera icon to start the camera stream to your smart device. The oven lights will illuminate while the camera is streaming. The camera stream will stop if the oven door is opened, and is not allowed during certain modes such as Proof and Self Clean.

# Sabbath



Sabbath mode disables the oven lights (the oven light will not turn on when the door is opened), all sounds (the control will not beep when the screen is pressed), Convection modes, Broil modes, Warm, Proof, and all time functions. Sabbath mode can only be used with traditional Bake. This feature conforms to the Star-K Jewish Sabbath requirements.

**NOTE:** If a power outage occurs during when the oven is in Sabbath Mode, the unit will return to Sabbath Mode when power is restored.

## Entering Sabbath Mode

Press the  on the main screen to access the Settings menu and scroll down to Sabbath.

## Start a Sabbath Bake

Use the keypad on the screen to enter the temperature that you would like to use for Sabbath Bake. Once the temperature is set, press the  to set the cook time for the cycle in hours and minutes. If using a double oven, you can then set the temperature and time desired for the other cavity by selecting it to the left of the temperature display. If a timer is not set, the oven will start a bake cycle during Sabbath mode and continue until Sabbath mode is turned off. You can also set whether the oven light will be on or off by pressing the  on this screen. Once you have programmed the temperature and time, press **Start**. The next screen will display the settings that you programmed for your Sabbath Bake.

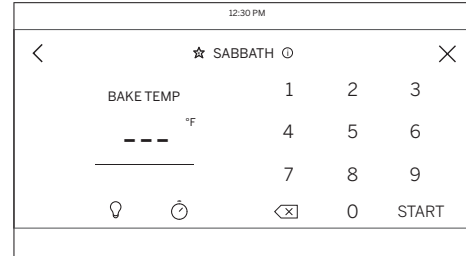

Programming Screens

## Adjusting the Temperature During a Sabbath Bake

If the temperature needs to be adjusted after programming the oven for a Sabbath Bake, press one of the temperature icons displayed on the Sabbath cycle screen and press **Enter**. This will allow you to adjust the temperature for the cycle. Note that the display will not show that the oven temperature has been changed.

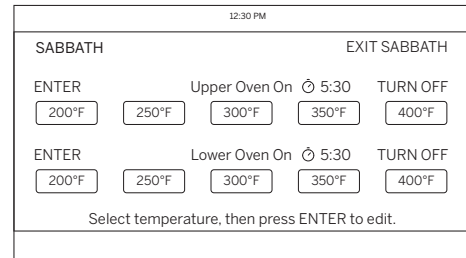
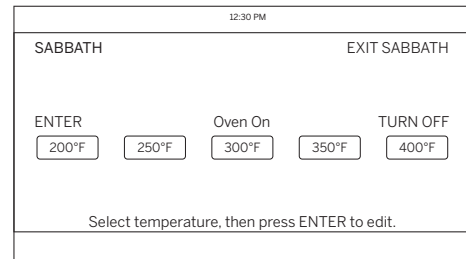

Single and Double Oven Sabbath Cycle Screens

## Exit the Sabbath Mode

To exit Sabbath mode, either press the **X** in the upper right corner if in the programming screen, or press **Exit Sabbath** if in the cycle screen. There is also an option to turn off the cycle when on the cycle screen by pressing **Turn Off**, but your oven will still remain in Sabbath mode until you exit the mode. **NOTE:** If a power outage occurs while the oven is in Sabbath Mode, the unit will return to Sabbath Mode when power is restored, however the oven will return to the off state even if it was in the middle of a bake cycle when the power outage occurred.

## Oven Racks

Your oven has six rack positions. Recommended rack positions for various types of foods are provided in the Cooking Guide. Adjusting rack position is one way to impact cooking results. For example, if you would prefer darker tops on cakes, muffins, or cookies, try moving food one rack position higher. If you find foods are too brown on top try moving them down next time.

When baking with multiple pans and on multiple racks, ensure there is sufficient space between pans to allow air to flow.

Your Oven may have extension racks and/or traditional flat racks.

To avoid possible burns, place the racks in the desired position before you turn the oven on.

### Flat Racks

When placing and removing cookware, pull the rack out to the bump (stop position) on the rack support.

To remove a rack, pull it toward you, tilt the front end up and pull it out.

To replace, place the curved end of the rack (stop-locks) onto the oven supports, tilt up the front of the rack and push the rack in.

Racks may become difficult to slide, especially after a self-clean. Put some vegetable oil on a soft cloth or paper towel and rub onto the left and right edges.

**NOTE:** Using other cooking oils will cause a discoloring or a rust like color residue on the racks and cavity sides. To clean this residue, use a soap and water or a vinegar and water solution. Rinse with clean water and dry with a soft cloth.

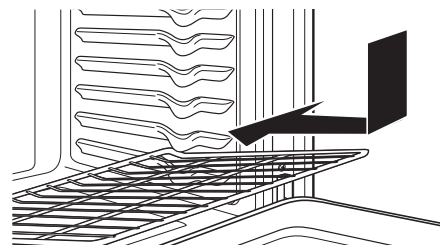
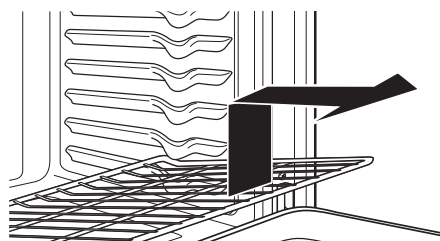
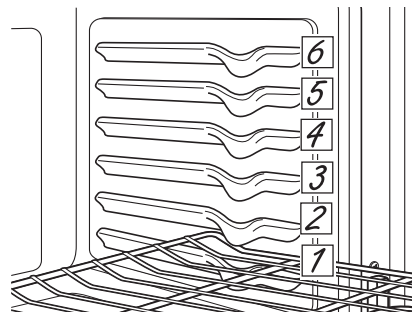

## Oven Racks (Cont.)

### Extension Racks

Always pull the rack out by its upper front rail to its fully open position, when placing or removing cookware. Extension racks cannot be used in the top rack position.

If extension racks are difficult to extend, lubricate the racks with the graphite lubricant provided with your oven. Remove the rack from the oven, remove debris in the side tracks with a paper towel, shake the graphite lubricant and place 4 small drops on the two bottom tracks of the left and right sides. Open and close the rack several times to distribute the lubricant.

To order additional graphite lubricant, read the Accessories section of the manual.

#### To Remove An Extension Rack:

1. Make sure the rack is pushed all the way into the oven so that side paddles on the rack disengage from the oven support.
2. Slide the rack toward you to the bump (stop position) on the rack support.
3. Firmly grasp both sides of the rack frame and the sliding rack, tilt the front end up and pull it out.

#### To Replace An Extension Rack:

1. Firmly grasp both sides of the rack frame and the sliding rack.
2. Place the curved end of the rack (stop-locks) onto the oven supports, tilt up the front of the rack and push it in as far as it will go.

If extension racks are difficult to replace or remove, wipe the oven rack supports with vegetable oil. Do not wipe oil on the rack slides.

**NOTE:** Using other cooking oils will cause a discoloring or a rust like color residue on the racks and cavity sides. To clean this residue, use a soap and water or a vinegar and water solution. Rinse with clean water and dry with a soft cloth.

#### To Lubricate the Paddle:

Shake lubricant and apply to the moving parts of the paddle mechanisms as shown.

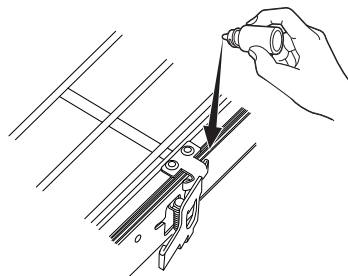
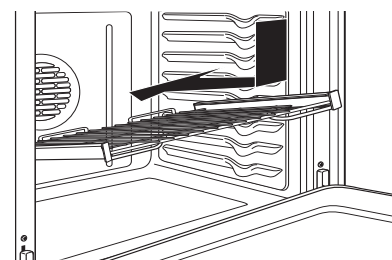
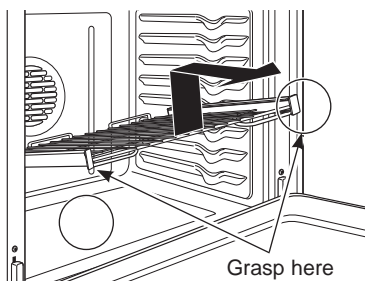
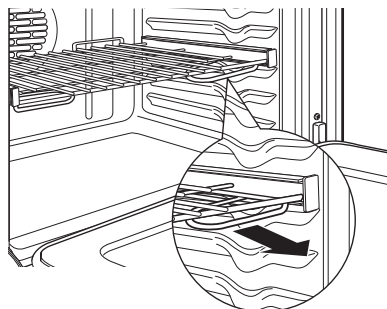
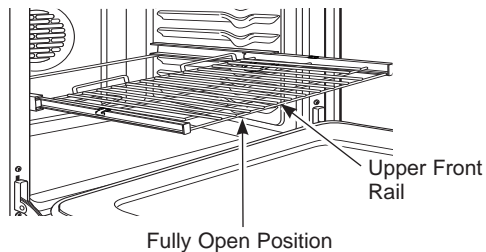

## Aluminum Foil and Oven Liners

**CAUTION** Do not use any type of foil or oven liner to cover the oven bottom. These items can trap heat or melt, resulting in damage to the product and risk of shock, smoke or fire. Damage from improper use of these items is not covered by the product warranty.

Foil may be used to catch spills by placing a sheet on a lower rack, several inches below the food. Do not use more foil than necessary and never entirely cover an oven rack with aluminum foil. Keep foil at least 1-1/2" from oven walls to prevent poor heat circulation.

## Cookware Guidelines

The material, finish, and size of cookware affect baking performance.

Dark, coated and dull pans absorb heat more readily than light, shiny pans. Pans that absorb heat more readily can result in a browner, crisper, and thicker crust. If using dark and coated cookware check food earlier than minimum cook time. If undesirable results are obtained with this type of cookware consider reducing oven temperature by 25° F next time.

Shiny pans can produce more evenly cooked baked goods such as cakes and cookies.

Glass and ceramic pans heat slowly but retain heat well. These types of pans work well for dishes such as pies and custards.

Air insulated pans heat slowly and can reduce bottom browning.

Keep cookware clean to promote even heating.

Cookware used in broil modes and air fry must be broil-safe.

## Oven Cooking Modes

Your new oven has a variety of cooking modes to help you get the best results. These modes are described below. Refer to the Cooking Guide section for recommendations for specific foods. Remember, your new oven may perform differently than the oven it is replacing.

### Baking and Roasting Modes

Select a mode for baking and roasting based on the type and quantity of food you are preparing. When preparing baked goods such as cakes, cookies, and pastries always preheat the oven first. Follow recipe recommendations for food placement. If no guidelines are provided, center food in the oven.

#### Traditional Bake

The traditional bake mode is intended for single rack cooking. This mode uses heat primarily from the lower element but also from the upper element to cook food. To use this mode press the **Bake** pad, enter a temperature, and then press **Start**. Preheating is generally recommended when using this mode.

#### Convection Bake Single Rack with Direct Air

The Convection Bake mode is intended for single rack cooking. This mode uses heat from the lower element and also the upper and rear elements, along with air movement directly down from the top of the oven to enhance evenness. Your oven is equipped with Auto Recipe Conversion, so it is not necessary to convert the temperature when using this mode. To use this mode press the **Bake** pad under **Convection**, enter a temperature, and then press **Start**. Preheating is generally recommended when using this mode.

### Convection Bake Multi Rack

The Convection Bake Multi Rack mode is intended for baking on multiple racks at the same time. This mode uses heat primarily from the rear element but also heat from the upper and lower elements, along with air movement from the convection fan to enhance cooking evenness. Your oven is equipped with Auto Recipe Conversion, so it is not necessary to convert the temperature when using this mode. Baking time might be slightly longer for multiple racks than what would be expected for a single rack. To use this mode press the **Bake Multi Rack** pad under **Convection**, enter a temperature, and then press **Start**. Always preheat when using this mode.

### Convection Roast with Direct Air

The Convection Roast mode is intended for roasting whole cuts of meat on a single rack. This mode uses heat from the lower, upper, and rear elements along with air movement directly down from the top of the oven to improve browning and reduce cooking time. It is not necessary to convert temperature. Check food earlier than the recipe suggested time when using this mode, or use the probe. To use this mode press the **Roast** pad under **Convection**, enter a temperature, and then press **Start**. It is not necessary to preheat when using this mode.

# Broiling Modes

---

Always broil with the door closed. The broil element in this oven is very powerful. Monitor food closely while broiling. Use caution when broiling on upper rack positions as placing food closer to the broil element increases smoking, spattering, and the possibility of fats igniting. **Broiling on rack position 6 is not recommended.**

Try broiling foods that you would normally grill. Adjust rack positions to adjust the intensity of the heat to the food. Place foods closer to the broil element when a seared surface and rare interior is desired. Thicker foods and foods that need to be cooked through should be broiled on a rack position farther from the broiler or by using Traditional Broil Lo or Convection Broil Lo. For best performance, center food below the broil heating element.

## Traditional Broil Hi

The Traditional Broil Hi mode uses intense heat from the upper element to sear foods. Use Broil Hi for thinner cuts of meat and/or foods you prefer less done on the interior. To use this mode press the **Broil** pad once under **Traditional** and then press **Start**. It is not necessary to preheat when using this mode.

## Traditional Broil Lo

The Traditional Broil Lo mode uses less intense heat from the upper element to cook food thoroughly while also producing surface browning. Use Broil Lo for thicker cuts of meat and/or foods that you would like cooked all the way through. To use this mode press the **Broil** pad **twice** under **Traditional** and then press **Start**. It is not necessary to preheat when using this mode.

## Convection Broil Hi with Direct Air

The Convection Broil Hi mode uses intense heat from the upper element along with air movement directly down from the top of the oven for improved searing and browning. To use this mode press the **Broil** pad once under **Convection** and then press **Start**. For best results preheat 5 minutes when using this mode.

## Convection Broil Lo with Direct Air

The Convection Broil Lo mode uses less intense heat from the upper element along with air movement directly down from the top of the oven. To use this mode press the **Broil** pad **twice** under **Convection** and then press **Start**. For best results preheat 5 minutes when using this mode.

## Specialty Cooking Modes

---

### Air Fry

The Air Fry mode is a special, no-preheat convection cooking mode designed to produce foods with a crispier exterior than traditional oven cooking. The Air Fry mode is intended for single rack cooking only. Select **Air Fry**, then input the desired set temperature and press Start. The temperature can be set between 300°F and 500°F. Preheating is not recommended for this mode. Follow traditional oven recipe or package guidelines for set temperatures and cook times; adjust cook time to achieve your desired crispness. Additional guidelines for using this mode can be found in the Cooking Guide.

### Warm

Warm mode is designed to keep hot foods hot for up to 3 hours. To use this mode, press the **More** pad, then **Warm**, and then press **Start**. Cover foods that need to remain moist and do not cover foods that should be crisp. Preheating is not required. Do not use warm to heat cold food other than crisping crackers, chips or dry cereal. It is also recommended that food not be kept warm for more than 2 hours.

### Proof

Proof mode is designed for rising (fermenting and proofing) bread doughs. Press the **More** pad, then **Proof**, and then press **Start**. Cover dough well to prevent drying out. Bread will rise more rapidly than at room temperature.

### Dehydrate

Dehydrate is a special convection mode that is designed for dehydrating foods such as fruits, vegetables or herbs, and making fruit leathers or jerkies. The dehydrate mode uses airflow and low heat to remove moisture from foods. Select More, then Dehydrate, then input the desired set temperature and press Start. The temperature can be set between 105°F and 225°F. Recommended temperature settings and expected time ranges for different food types, as well as additional instructions related to this mode are available in the dehydrating guide. When the dehydrate mode is running, 12 hour shut-off is automatically disabled. The door must be partially open when running the dehydrate mode. Prop oven door open with the dehydrate door stopper included with your wall oven.

### Precision Cooking

These modes provide guidance or pre-set cooking algorithms to assist the user in cooking various types of food. The selection you make in the Precision Cooking menu will guide you to input the information required to help cook your food. At the end of estimated cooking time, check the food to see if it is done to your liking. Note that differences in food shape, preparation and preferences for doneness can impact the time required to cook the food.

Some cycles require the food temperature probe supplied with your oven. The target temperature for the probe is automatically set based on selections made for each food. Always check foods using a secondary food thermometer as probe placement can impact the measured temperature. See Probe section for more details on using and positioning the probe properly.

On some screens ① will show up. Press ① to access additional information that pertains to the cooking cycles within the category.

Additional cycles will be available through software updates. Connect your oven to have access to these updates. See the WiFi Connect section for details on how to connect your oven.

# Probe

Internal food temperature is frequently used as an indicator of doneness, especially for roasts and poultry. The Probe mode monitors the internal food temperature and turns the oven off when the internal food temperature reaches the programmed temperature.

## ▲WARNING

Consuming undercooked food can result in foodborne illness. Use probe according to the following instructions to ensure all portions of the food reach minimum safe cooking temperatures. Recommendations for minimum safe food temperatures can be found at [foodsafety.gov](http://foodsafety.gov) or [IsItDoneYet.gov](http://IsItDoneYet.gov). Always check the temperature at multiple locations in the food with a food thermometer after cooking to ensure that all portions of the food have reached the minimum safe internal temperature for that food.

## Proper Probe Placement

After preparing the meat and placing it on the cooking pan follow these instructions for proper probe placement.

- Insert the probe into the food, so that the tip of the probe will rest in the center of the thickest part of the food. For best performance the probe should be fully inserted into the food. If the probe is not located properly, it may not accurately measure the temperature of the coolest portion of the food. Some foods, particularly small items, are not well suited for cooking with the probe due to their shape or size.
- The probe should not touch bone, fat or gristle.
- For whole poultry insert the probe into the thickest part of the breast.
- For boneless roasts, insert the probe into the center of the roast.
- For bone-in ham or lamb, insert the probe into the center of the lowest large muscle or joint.
- For casseroles or dishes such as meatloaf, insert the probe into the center of the dish.
- For fish, insert the probe from just above the gill into the meatiest area, parallel to the backbone.

## Probe Usage

### To use the probe without preheating:

1. Insert the probe into the food (see Proper Probe Placement).
2. Place the food in the oven and connect the probe into the probe outlet in the oven.
3. Select the desired cooking mode and temperature. Before pressing start, press the **Probe** icon at the bottom right of the screen. The probe setting screen will be displayed. Enter the desired internal food temperature and press **Start**. The probe temperature can be set between 100°F and 200°F.

### To use the probe with preheating:

1. Press the desired cook mode (Traditional **Bake**, Convection **Bake**, or Convection **Roast**) pad and enter the desired cooking temperature.
2. Insert the probe into the food (see Proper Probe Placement).
3. Once the oven is preheated, place the food in the oven and connect the probe to the probe outlet, making sure it is fully inserted. Use caution, the oven walls and probe outlet are hot.
4. The oven will detect that the probe has been inserted and the probe setting screen will be displayed. Enter the desired internal food temperature and press **Start**. The probe temperature can be set between 100°F and 200°F.

## Probe Care Guidelines

**NOTE:** some double oven models have a probe in the upper oven only.

- Use of probes other than the one provided with this product may result in damage to the probe.
- Use the handles of the probe and plug when inserting and removing them from the meat and outlet
- To avoid damaging your probe, do not use tongs to pull on the cable when removing it.
- To avoid breaking the probe, make sure food is completely defrosted before inserting the probe.
- To prevent possible burns, do not unplug the probe from the outlet until the oven has cooled.
- Never leave the probe inside the oven during a self or steam clean cycle.
- Do not store the probe in the oven.



# Cooking Guide - Single Ovens and Upper Ovens

The table below provides some guidelines for typical cooking modes. If you would like to use Precision Cooking modes they can be substituted for the modes shown below for applicable foods.

FOOD TYPE	RECOMMENDED MODE(S)	RECOMMENDED RACK POSITION(S)	ADDITIONAL SUGGESTIONS
<b>Baked Goods</b>			
Layer cakes, sheet cakes, bundt cakes, muffins, quick breads on a Single Rack	Convection Bake Traditional Bake	3	Use shiny cookware.
Layer cakes* on Multiple Racks	Convection Bake Multi	2 and 4	Ensure adequate airflow (see illustration below).
Chiffon cakes (angel food)	Convection Bake Traditional Bake	1	Use shiny cookware.
Cookies, biscuits, scones on a Single Rack	Convection Bake Traditional Bake	3	Use shiny cookware.
Cookies, biscuits, scones on Multiple Racks	Convection Bake Multi	2 and 4	Ensure adequate airflow.
<b>Beef &amp; Pork</b>			
Hamburgers	Broil Hi	5 ext.	Use a broil pan; move food down for more doneness/less searing. Watch food closely when broiling. For best performance, center food below the broil heating element.
Steaks & Chops	Broil Hi	5 ext.	Use a broil pan; move food down for more doneness/less searing. Watch food closely when broiling. For best performance, center food below the broil heating element.
Roasts	Traditional Bake Convection Roast	1 or 2	Leave uncovered, use a low sided pan such as a broil pan. Preheating is not necessary.
<b>Poultry</b>			
Whole chicken	Traditional Bake Convection Roast	2	Use a low sided pan such as a broil pan. Preheating is not necessary.
Bone-in chicken breasts, legs, thighs	Broil Lo Traditional Bake Convection Roast	2 or 3	Broil skin side down first. Watch food closely when broiling. For best performance when broiling, center food below the broil heating element.
Boneless chicken breasts	Broil Lo Traditional Bake Convection Roast	2 or 3	Move food down for more doneness/less searing and up for greater searing/browning when broiling. For best performance when broiling, center food below the broil heating element.
Whole turkey	Traditional Bake Convection Roast	1 or 2	Use a low sided pan such as a broil pan. Preheating is not necessary.
Turkey Breast	Traditional Bake Convection Roast	1 or 2	Use a low sided pan such as a broil pan. Preheating is not necessary.
<b>Fish</b>	Broil Lo	5 (1/2 thick or less) 4 (>1/2 inch)	Watch food closely when broiling. For best performance, center food below the broil heating element.
<b>Casseroles</b>	Convection Bake Traditional Bake	3	
<b>Frozen Convenience Foods</b>			
Pizza on a single rack	Convection Bake Traditional Bake	3	Use shiny cookware.
Pizza on multiple racks	Convection Bake Multi	2 and 4	Use shiny cookware.
Potato products, chicken nuggets, appetizers on single racks	Convection Bake Traditional Bake	3	Use shiny cookware when using traditional bake and convection bake.
	Air Fry (on single and upper ovens only)		Use dark cookware or cookie sheet when using Air Fry.
Potato products, chicken nuggets, appetizers on multiple racks	Convection Bake Multi	2 and 4	Use shiny cookware. Switch food location partially through cooking for more even cooking results.

\*When baking four cake layers at a time, use racks on 2 and 4 for a single/upper oven. Place the pans as shown so that one pan is not directly above another.

Cook food thoroughly to help protect against food borne illness. Minimum safe food temperature recommendations for food safety can be found at [IsItDoneYet.gov](http://IsItDoneYet.gov). Make sure to use a food thermometer to take food temperatures.

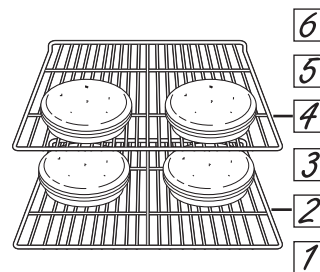

Single/upper oven

# Cooking Guide - Lower Double Oven

The table below provides some guidelines for typical cooking modes. If you would like to use Precision Cooking modes they can be substituted for the modes shown below for applicable foods.

FOOD TYPE	RECOMMENDED MODE(S)	RECOMMENDED RACK POSITION(S)	ADDITIONAL SUGGESTIONS
<b>Baked Goods</b>			
Layer cakes, sheet cakes, bundt cakes, muffins, quick breads on a Single Rack	Convection Bake Traditional Bake	3	Use shiny cookware.
Layer cakes* on Multiple Racks	Convection Bake Multi	1 ext. and 4 flat	Ensure adequate airflow (see illustration below).
Chiffon cakes (angel food)	Convection Bake Traditional Bake	1	Use shiny cookware.
Cookies, biscuits, scones on a Single Rack	Convection Bake Traditional Bake	3	Use shiny cookware.
Cookies, biscuits, scones on Multiple Racks	Convection Bake Multi	1 ext. and 4 flat	Ensure adequate airflow.
<b>Beef &amp; Pork</b>			
Hamburgers	Broil Hi	5 ext.	Use a broil pan; move food down for more doneness/less searing. Watch food closely when broiling. For best performance, center food below the broil heating element.
Steaks & Chops	Broil Hi	5 ext.	Use a broil pan; move food down for more doneness/less searing. Watch food closely when broiling. For best performance, center food below the broil heating element.
Roasts	Traditional Bake Convection Roast	1 or 2	Leave uncovered, use a low sided pan such as a broil pan. Preheating is not necessary.
<b>Poultry</b>			
Whole chicken	Traditional Bake Convection Roast	2	Use a low sided pan such as a broil pan. Preheating is not necessary.
Bone-in chicken breasts, legs, thighs	Broil Lo Traditional Bake Convection Roast	2 or 3	Broil skin side down first. Watch food closely when broiling. For best performance when broiling, center food below the broil heating element.
Boneless chicken breasts	Broil Lo Traditional Bake Convection Roast	2 or 3	Move food down for more doneness/less searing and up for greater searing/browning when broiling. For best performance when broiling, center food below the broil heating element.
Whole turkey	Traditional Bake Convection Roast	1 or 2	Use a low sided pan such as a broil pan. Preheating is not necessary.
Turkey Breast	Traditional Bake Convection Roast	1 or 2	Use a low sided pan such as a broil pan. Preheating is not necessary.
<b>Fish</b>	Broil Lo	5 (1/2 thick or less) 4 (>1/2 inch)	Watch food closely when broiling. For best performance, center food below the broil heating element.
<b>Casseroles</b>	Convection Bake Traditional Bake	3	
<b>Frozen Convenience Foods</b>			
Pizza on a single rack	Convection Bake Traditional Bake	3	Use shiny cookware.
Pizza on multiple racks	Convection Bake Multi	1 ext. and 4 flat	Use shiny cookware.
Potato products, chicken nuggets, appetizers on single racks	Convection Bake Traditional Bake	3	Use shiny cookware when using traditional bake and convection bake.
	Air Fry (on single and upper ovens only)		Use dark cookware or cookie sheet when using Air Fry.
Potato products, chicken nuggets, appetizers on multiple racks	Convection Bake Multi	1 ext. and 4 flat	Use shiny cookware. Switch food location partially through cooking for more even cooking results.

\*When baking four cake layers at a time, use 1 extension and 4 flat for a lower double oven. Place the pans as shown so that one pan is not directly above another.

Cook food thoroughly to help protect against food borne illness. Minimum safe food temperature recommendations for food safety can be found at [IsItDoneYet.gov](http://IsItDoneYet.gov). Make sure to use a food thermometer to take food temperatures.

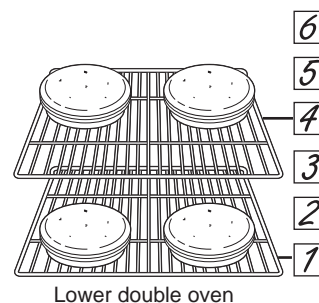

# Cooking Guide

## Air Fry Cooking Guide

Air Fry is a special, no-preheat, cooking mode that is designed to produce foods with a crispier exterior than traditional oven cooking. Select **Air Fry**, then input the desired set temperature and press **Start**. The temperature can be set between 300°F and 500°F.

### Air Fry Cookware Guidelines

- Only use broil safe cookware when using Air Fry mode.
- A dark sheet pan is recommended. A dark pan promotes better browning and crisping.
- Oven baking baskets and baking grids can also be used. A sheet pan should be placed on the rack below the foods to catch any drippings when using a baking basket.

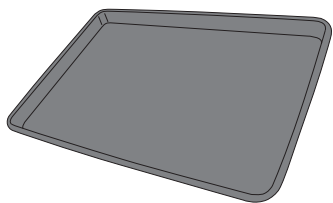

Primary recommended cookware

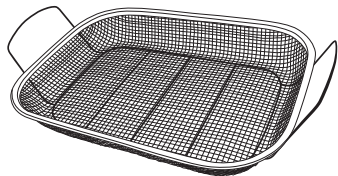
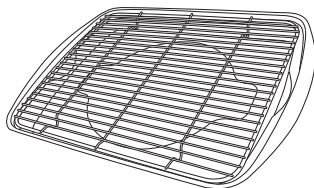

Alternate cookware options

## General Tips for Air Fry Mode

- The Air Fry mode is designed for cooking on a single rack.
- The Air Fry mode is designed to be used without preheating.
- Rack position 3 is recommended for most foods. If foods are browning too rapidly try using a lower rack position.
- Foods may cook faster than expected if the oven is already hot when food is placed in the oven.
- When air frying foods with sauce, it is recommended to apply the sauce at the end of cooking.
- If foods are browning too quickly, try a lower rack position or lower oven set temperature.
- For packaged foods, use traditional oven cooking instructions for set temperature and expected cook time.
- It is not necessary to flip or stir food during cooking
- Arrange food in a single layer on the pan, do not overload the pan.
- Always check internal food temperature to confirm minimum safe temperatures have been reached. Minimum safe food temperatures can be found on packages and at [IsItDoneYet.gov](http://IsItDoneYet.gov).

FOOD TYPE	RECOMMENDED RACK POSITION(S)	RECOMMENDED SET TEMPERATURES (F°)	RECOMMENDED COOK TIME (MIN)	NOTES
Fresh boneless fish or poultry pieces, breaded such as nuggets, tenders, fillets	3 extension	375-400	15-30	User lower set temperatures for larger pieces. Use shiny cookware.
Fresh bone in chicken wings	3 extension	375-400	25-40	Salt wings or coat in a dry rub, if using sauce apply after cooking or toward the end of cooking
Fresh bone in chicken drumsticks or thighs	3 extension	375-400	30-55	User lower set temperatures for larger pieces.
Fresh French fries, thin (< ½ inch)	3 extension	400-425	15-30	Parchment paper is recommended when preparing fresh French fries. For crispier fries, toss fries in corn starch or rice flour before cooking.
Fresh French fries, thick (> ½ inch)	3 extension	375-400	20-35	Parchment paper is recommended when preparing fresh French fries. For crispier fries, toss fries in corn starch or rice flour before cooking.
Frozen packaged foods	3 extension	Use traditional oven(not Air Fry) cooking instructions as a guideline for set temperature and cook time. Additional cook time beyond recommended package time may be required for some foods. If oven is hot when starting, food may cook faster than the minimum package time.		

# Cooking Guide

## Dehydrating Guide (upper oven only on double oven models)

Dehydrate is a special convection mode that is designed for dehydrating foods such as fruits, vegetables or herbs, and making fruit leathers or jerkies. The dehydrate mode uses airflow and low heat to remove moisture from foods. The door must be partially open when running the dehydrate mode. Use the door spacer provided with your oven to prop the door open to the appropriate position as shown below. Once the door prop is in place, select **More**, then **Dehydrate**, then input the desired set temperature and press **Start**. The temperature can be set between 105°F and 225°F. When the dehydrate mode is running, 12 hour shut-off is automatically disabled.

Door Spacer to be used when dehydrating

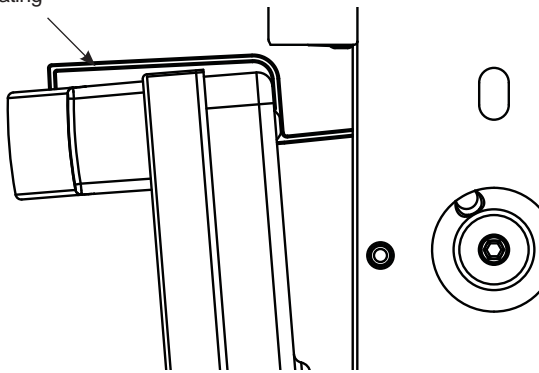

- It is normal to see moisture on the interior oven surfaces when dehydrating.
- Some foods benefit from a pretreatment.
- Remove excess moisture from the exterior of foods prior to dehydrating.
- Pierce, check, or cut foods such as blueberries, cranberries or grapes prior to dehydrating.
- Periodically blot meats to remove excess fat during dehydrating.
- Dehydrating more than 4 racks at a time is not recommended.

Food Type	Recommended Set Temperature (°F)	Expected Drying Time (hours)
Fruits	130-140	4 - 36
Herbs	105-115	2 - 18
Meat/Jerky*	145-165	4 - 12
Vegetables	125-130	3 - 24

\*Meat should be heated to 165°F before dehydrating. See [fsis.usda.gov](http://fsis.usda.gov) for more information

- Consult online and book references for detailed information on how to safely and properly dehydrate foods.
- Dehydrating at too high of a temperature can prevent the interior of foods from sufficiently drying.
- Dehydrating at too low of a temperature or too slowly can allow microorganisms to grow resulting in spoilage or food borne illness.
- Do not only rely on exterior appearance or texture, check food interior to ensure that foods are sufficiently dried.
- Dehydrating times are impacted by the initial condition of the food, ambient humidity, temperature setting, quantity of food, etc. Thinner, smaller pieces of foods will dehydrate more quickly than thicker or larger pieces.
- For best performance when using the dehydrate mode use grids or racks with small spacing that allow air to reach food from all sides. These can be placed directly on your oven rack. Parchment paper or silicone baking mats can be used for dehydrating purees.

Number of Oven Racks Used During Dehydrate Mode	Rack Positions in Your Oven
1 rack	3 (flat or extension rack)
2 racks	2 (extension rack) and 4 (flat rack)
3 racks	2 (flat rack), 3 (extension rack) and 5 (flat rack)
4 racks	2 (flat rack), 3 (flat rack), 4 (flat rack), and 5 (flat rack)

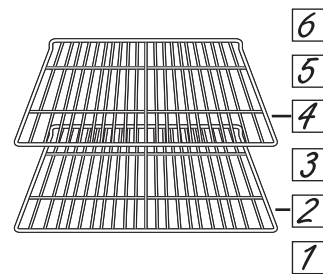

## Cleaning The Oven - Exterior

---

Be sure electrical power is off and all surfaces are cool before cleaning any part of the range.

### Control Panel

To lock the controls, press  in the bottom left corner and follow instructions on the display. Instructions for unlocking are visible when the display is locked. It's a good idea to wipe the control panel after each use. Clean with mild soap and water or vinegar and water,

rinse with clean water and polish dry with a soft cloth. Do not use abrasive cleansers, strong liquid cleansers, plastic scouring pads or oven cleaners on the control panel—they will damage the finish.

---

### Oven Exterior

Do not use oven cleaners, abrasive cleansers, strong liquid cleansers, steel wool, plastic scouring pads, or cleaning powders on the interior or exterior of the oven. Clean with a mild soap and water or vinegar and water solution. Rinse with clean water and dry with a soft cloth. When cleaning surfaces, make sure that they are at room temperature and not in direct sunlight.

If stain on the door vent trim is persistent, use a mild abrasive cleaner and a sponge-scrubber for best results.

Spillage of marinades, fruit juices, tomato sauces and basting liquids containing acids may cause discoloration and should be wiped up immediately. Let hot surfaces cool, then clean and rinse.

---

### Painted Surfaces and Black Stainless Steel (on some models)

Painted surfaces may include the door and trim around the control panel. Clean these with soap and water or a vinegar and water solution.

Do not use commercial oven cleaners, cleaning powders, steel wool or harsh abrasives on any painted surface, including Black Stainless Steel.

---

### Stainless Steel - Excluding Black Stainless Steel (on some models)

Do not use a steel wool pad; it will scratch the surface.

To clean the stainless steel surface, use warm sudsy water or a stainless steel cleaner or polish. Always wipe the surface in the direction of the grain. Follow the cleaner instructions for cleaning the stainless steel surface.

Cleaners with oxalic acid such as Bar Keepers Friend Soft Cleanser™ will remove surface rust, tarnish and small blemishes. Use only a liquid cleanser free of grit and rub in the direction of the brush lines with a damp, soft sponge.

To inquire about purchasing cleaning products including stainless steel appliance cleaner or polish, see the Accessories and Consumer Support sections at the end of this manual.

# Cleaning The Oven - Interior

---

The interior of your new oven can be cleaned manually or by using Steam Clean or Self Clean modes.

Spillage of marinades, fruit juices, tomato sauces and basting liquids containing acids may cause discoloration and should be wiped up immediately. Let hot surfaces cool, then clean and rinse.

**IMPORTANT:** For models with Oven Camera in the door: If door glass is not clean, camera image clarity may be affected. Please follow directions below to properly clean the door glass.

## Manual Cleaning

Do not use oven cleaners (unless certified for self-cleaning oven), strong liquid cleansers, steel wool, or scouring pads on the interior of the oven. Clean with a mild soap and water, or vinegar and water solution.

Rinse with clean water and dry with a soft cloth. When cleaning surfaces, make sure that they are at room temperature.

---

## Steam Clean Mode

Steam clean is intended to clean small spills using water and a lower cleaning temperature than Self-Clean.

To use the Steam Clean feature, wipe grease and soils from the oven. Pour one cup of water into the bottom of the oven. Close the door. Press the **More** option, then select **Steam Clean**, and press **Start** to the right of the

screen. The oven door will lock. You cannot open the door during the 30 minute steam clean as this will decrease the steam clean performance. At the end of the steam clean cycle the door will unlock. Wipe out any excess water and any remaining soil. **NOTE:** Water in the bottom of the oven may be hot right after finishing the cycle.

---

## Self Clean Mode

Read Self-Cleaning Oven Safety Instructions at the beginning of this manual before using Self Clean Mode. Self clean uses very high temperatures to clean the oven interior. The oven door will lock when using this feature. Before operating the self clean cycle, wipe up grease and soils from the oven. Remove all items from the oven other than enameled (dark color) racks. Shiny or silver racks, the meat probe, and any cookware or other items should all be removed from the oven before initiating a self clean cycle. Close the door. If using a double oven, select which oven you would like to clean. Select the **More** option, then **Self Clean**. Choose a 3, 4, or 5 hour cycle, and select the illuminated **Start** pad to the right of the screen. For heavily soiled ovens, the maximum 5 hour clean time is recommended. If you wish to use the default time, press **Start** immediately after selecting **Self Clean**. The oven will show that the door has locked and display the amount of time remaining in the cycle. Press the illuminated **Cancel** pad to the right of the screen if you wish to stop the cycle. The oven will turn off automatically when the self clean cycle is complete. The door will stay locked until the oven has cooled down. After the oven has cooled down wipe any ash out of the oven.

We recommend venting your kitchen with an open window or using a ventilation fan or hood during the first self-clean cycle.

Soil on the front frame of the oven and outside the gasket on the door will need to be cleaned by hand. Clean these areas with hot water, soap-filled steel wool pads or cleaners such as Soft Scrub®. Rinse well with clean water and dry.

Do not clean the gasket. The fiberglass material of the oven door gasket cannot withstand abrasion. It is essential for the gasket to remain intact. If you notice it becoming worn or frayed, replace it.

Make sure the oven light bulb cover is in place and the oven light is off. When using the Self Clean Mode in a double oven, only the upper or lower oven can utilize the cycle at one time. Additionally, no other mode may be started in the alternate oven cavity while self clean is in progress.

**IMPORTANT:** The health of some birds is extremely sensitive to the fumes given off during the self-cleaning cycle of any range. Move birds to another well-ventilated room.

## Probe

The temperature probe may be cleaned with soap and water or a soap-filled scouring pad. Cool the temperature probe before cleaning. Scour stubborn spots with a soap-filled scouring pad, rinse and dry.

To order additional temperature probes see the Accessories and Consumer Support sections at the end of this manual.

- Do not immerse the temperature probe in water.
- Do not store the temperature probe in the oven.
- Do not leave the temperature probe inside the oven during a self or steam clean cycle.

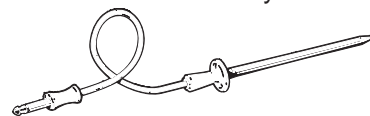

## Oven Light

**⚠ WARNING SHOCK OR BURN HAZARD:** Before replacing oven light bulb, disconnect the electrical power to the oven at the main fuse or circuit breaker panel. Failure to do so may result in electric shock or burn.

**⚠ CAUTION BURN HAZARD:** The glass cover and bulb should be removed when cool. Touching hot glass with bare hands or a damp cloth can cause burns.

1. Disconnect power at the main fuse or circuit breaker panel.
2. Remove oven racks.
3. Slide a flat blade screwdriver or butter knife between the metal housing and the glass light cover.  
**NOTE:** on some models there is a metal clip visibly holding the glass. The tool needs inserted between the metal housing and the clip holding the glass.
4. Support the glass light cover with two fingers to prevent the cover from falling to the bottom of the oven.
5. Gently twist the screwdriver blade or butter knife to loosen the glass light cover. Be careful not to chip the oven coating.
6. Remove the glass light cover.
7. Remove the bulb by firmly grasping and sliding the bulb straight out until the two prongs have cleared the ceramic holder.
8. Do not touch the glass of the new replacement bulb with your fingers. It will cause the bulb to fail when it lights. Grasp the replacement bulb with a clean towel or facial tissue with the prongs facing down. Align the two prongs in the ceramic holder, pressing gently until the bulb is securely in the ceramic socket.
9. Slide the protective lens into the holder and push until the clips snap into the housing.
10. Reconnect power.

# Oven Door

The door is very heavy. Be careful when removing and lifting the door. Do not lift door by the handle.

Before removing the door, disconnect the camera harness by unhooking the connector that is snapped into the bottom of the door.

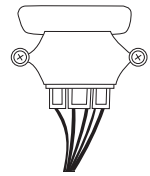

## Oven Door Removal

**NOTE:** Door removal is not a requirement for installation of the product but is an added convenience.

**To remove the door:**

1. Open the oven door as far as it will go.
2. Push both hinge locks down toward the door frame to the unlocked position. This may require a flat-blade screwdriver. **DO NOT LIFT THE DOOR BY THE HANDLE!**

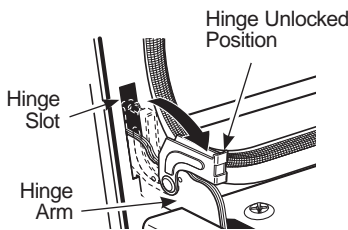

3. Place hands on both sides of the door and close the oven door to the removal position (approximately 1"–2" [2.5 cm–5.1 cm] from the closed position).
4. Lift the door up and out until the hinge arms clear the slots. **NOTE:** The oven door is very heavy. Be sure you have a firm grip before lifting the oven door off the hinges. Use caution once the door is removed. Do not lay the door on its handle. This could cause dents or scratches.

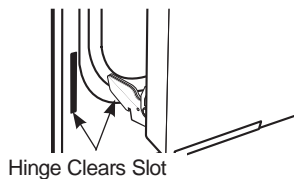

## Replacing the Oven Door

**NOTE:** The oven door is heavy. You may need help lifting the door high enough to slide it into the hinge slots. Do not lift the door by the handle.

1. Lift the oven door by grasping each side.
2. With the door at the same angle as the removal position (approximately 1"–2" [2.5 cm–5.1 cm] from the closed position), seat the notch of the hinge arm into the bottom edge of the hinge slot. The notch of the hinge arm must be fully seated into the bottom of the slot.

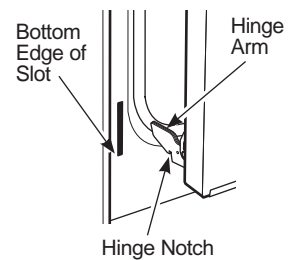
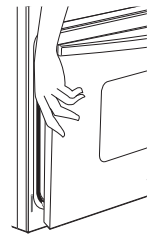

3. Fully open the door. If the door will not fully open, the indentation is not seated correctly in the bottom edge of the slot.
4. Push the hinge locks up against the front frame of the oven cavity, to the locked position.
5. Close the oven door.

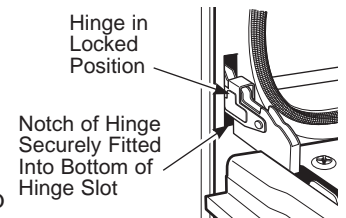



# Troubleshooting tips ... Before you call for service

Save time and money! Review the charts on the following pages first and you may not need to call for service.

Problem	Possible Cause	What To Do
My new oven doesn't cook like my old one. Is something wrong with the temperature settings?	Your new oven has a different cooking system from your old oven and therefore may cook differently than your old oven.	For the first few uses, follow your recipe times and temperatures carefully. If you still think your new oven is too hot or too cold, you can adjust the temperature yourself to meet your specific cooking preference. See the Special Features Section to adjust the oven temperature. <b>NOTE:</b> This adjustment affects Traditional Bake, Convection Bake and Convection Bake Multi temperatures; it will not affect Convection Roast, Traditional Broil, Convection Broil or Clean.
Food does not bake properly	Oven controls improperly set.	See the Cooking Modes section.
	Rack position is incorrect or rack is not level.	See the Cooking Modes section and Cooking Guide.
	Incorrect cookware or cookware of improper size being used.	See the Cookware section.
	Oven temperature needs adjustment.	See the Cooking option under the Settings section.
	Ingredient substitution	Substituting ingredients can change the recipe outcome.
Food does not broil properly	Oven controls improperly set.	Make sure you select the appropriate broil mode.
	Improper rack position being used.	See the Cooking Guide for rack location suggestions.
	Food being cooked in a hot pan.	Make sure cookware is cool
	Cookware not suited for broiling.	Use a pan specifically designed for broiling
	Aluminum foil used on the broiling pan and grid has not been fitted properly and slit as recommended.	If using aluminum foil conform to pan slits.
	In some areas the power (voltage) may be low.	Preheat the broil element for 10 minutes.
Oven temperature too hot or too cold	Oven temperature needs adjustment.	See the Cooking option under the Settings section.
Oven does not work or appears not to work	A fuse in your home may be blown or the circuit breaker tripped.	Replace the fuse or reset the circuit breaker.
	Oven controls improperly set.	See the Using the Oven section.
	Oven is in Sabbath Mode	Verify, that the oven is not in Sabbath Mode. See the Sabbath option under the Settings section.
"Crackling" or "popping" sound	This is the sound of the metal heating and cooling during both the cooking and cleaning functions.	This is normal.
Why is my range making a "clicking" noise when using my oven?	Your range has been designed to maintain a tighter control over your oven's temperature. You may hear your oven's heating elements "click" on and off more frequently than in older ovens to achieve better results during baking, broiling, convection, and self-clean cycles.	This is normal.
Clock and timer do not work	A fuse in your home may be blown or the circuit breaker tripped.	Replace the fuse or reset the circuit breaker.
Oven light does not work	Light bulb is loose or defective.	Tighten or replace bulb.
Oven will not self-clean	The temperature is too high to set a self-clean operation.	Allow the oven to cool and reset the controls.
	Oven controls improperly set.	See the Cleaning the Oven section.
Excessive smoking during clean cycle	Excessive soil or grease.	Press <b>Cancel</b> on the pad to the right of the screen to stop the cycle. Open the windows to rid the room of smoke. Wait until the door unlocks. Wipe up the excess soil and reset the clean cycle.

# Troubleshooting tips ... Before you call for service

Problem	Possible Cause	What To Do
Excessive smoking during broiling	Food too close to burner element.	Lower the rack position of the food.
Oven door will not open after a clean cycle	Oven too hot.	Allow the oven to cool below locking temperature.
Oven not clean after a clean cycle	Oven controls improperly set.	See the Cleaning the Oven section.
	Oven was heavily soiled.	Clean up heavy spillovers before starting the clean cycle. Heavily soiled ovens may need to self-clean again or for a longer period of time.
“F— and a number or letter” are displayed on LCD screen	You have a function error code.	Press <b>Dismiss</b> on the LCD screen. Allow the oven to cool for one hour. Put the oven back into operation.
	If the function code repeats.	Disconnect all power to the oven for at least 30 seconds and then reconnect power. If the function error code repeats, call for service.
LCD is not functioning properly	A fuse in your home may be blown or the circuit breaker tripped.	Replace the fuse or reset the circuit breaker.
	Oven controls improperly set.	See the Cooking Modes or Settings section to ensure proper use. Ensure unit is updated to the most recent software update.
	LCD screen is locked.	Unlock the screen by pressing the <b>Unlock</b> icon. If this does not correct the issue, cycle power at the circuit breaker and ensure unit is updated to the most recent software update.
	LCD is faulty.	Cycle power at the circuit breaker and ensure unit is updated to the most recent software update. If issue persists, call service to assess the issue.
Power outage, clock resets	Power outage or surge	Reset the clock. If the oven was in use, you must reset it by pressing <b>Cancel</b> , setting the clock and resetting any cooking function.
“Burning” or “oily” odor emitting from the vent	This is normal in a new oven and will disappear in time.	To speed the process, set a self-clean cycle for a minimum of 3 hours. See the Cleaning the Oven section.
Strong odor	An odor from the insulation around the inside of the oven is normal for the first few times the oven is used.	This is temporary and will go away after several uses or a self-clean cycle.
Fan noise	A cooling fan may automatically turn on.	This is normal. The cooling fan will turn on to cool internal parts. It may run for up to 1-1/2 hours after the oven is turned off.
My oven door glass appears to be “tinted” or have a “rainbow” color. Is this defective?	No. The inner oven glass is coated with a heat barrier to reflect the heat back into the oven to prevent heat loss and keep the outer door cool while baking.	This is normal. Under certain light or angles, you may see this tint or rainbow color.
Sometimes the oven takes longer to preheat to the same temperature	Cookware or food in oven	The cookware or food in the oven will cause the oven to take longer to preheat. Remove items to reduce preheat time.
	Number of racks in oven	Adding more racks to the oven will cause the oven to take longer to preheat. Remove some racks.
	Different cooking modes	The different cooking modes use different preheat methods to heat the oven for the specific cooking mode. Some modes will take longer than others (i.e. convection bake multi).
Oven will not work remotely	Router issues, no wireless signal, etc.	For assistance with oven wireless network connectivity, please call 1-800-220-6899.
	Oven is not connected.	
Oven camera image is not clear	Oven door glass is dirty	Follow directions in Cleaning the Oven section to properly clean oven door glass.
No image on oven camera app	Camera cable unplugged	Check to make sure camera cable is plugged into bottom of door.

# Café Electric Oven Limited Warranty

## cafeappliances.com

All warranty service is provided by our Factory Service Centers, or an authorized service technician. To schedule service online, visit us at [cafeappliances.com/service](http://cafeappliances.com/service). Please have your serial number and your model number available when scheduling service.

Servicing your appliance may require the use of the onboard data port for diagnostics. This gives a Café factory service technician the ability to quickly diagnose any issues with your appliance and helps Café improve its products by providing Café with information on your appliance. If you do not want your appliance data to be sent to Café, please advise your technician not to submit the data to Café at the time of service.

For the period of	Café will replace
<b>One year</b> From the date of the original purchase	<b>Any part</b> of the oven which fails due to a defect in materials or workmanship. During this <b>limited one-year warranty</b> , Café will provide, <b>free of charge</b> , all labor and in-home service to replace the defective part.

### What Café will not cover:

- Service trips to your home to teach you how to use the product.
- Improper installation, delivery or maintenance.
- Failure of the product if it is abused, misused, modified or used for other than the intended purpose or used commercially.
- Replacement of house fuses or resetting of circuit breakers.
- Damage to the product caused by accident, fire, floods or acts of God.
- Damage to finish, such as surface rust, tarnish, or small blemishes not reported within 48 hours of delivery.
- Incidental or consequential damage caused by possible defects with this appliance.
- Damage caused after delivery.
- Product not accessible to provide required service.
- Service to repair or replace light bulbs, except for LED lamps.

### EXCLUSION OF IMPLIED WARRANTIES

Your sole and exclusive remedy is product repair as provided in this Limited Warranty. Any implied warranties, including the implied warranties of merchantability or fitness for a particular purpose, are limited to one year or the shortest period allowed by law.

This limited warranty is extended to the original purchaser and any succeeding owner for products purchased for home use within the USA. If the product is located in an area where service by a Café Authorized Servicer is not available, you may be responsible for a trip charge or you may be required to bring the product to an Authorized Café Service location for service. In Alaska, the limited warranty excludes the cost of shipping or service calls to your home.

Some states do not allow the exclusion or limitation of incidental or consequential damages. This limited warranty gives you specific legal rights, and you may also have other rights which vary from state to state. To know what your legal rights are, consult your local or state consumer affairs office or your state's Attorney General.

**Warrantor: GE Appliances, a Haier company**

Louisville, KY 40225

**Extended Warranties:** Purchase a Café extended warranty and learn about special discounts that are available while your warranty is still in effect. You can purchase it online anytime at

[cafeappliances.com/extended-warranty](http://cafeappliances.com/extended-warranty)

Café Service will still be there after your warranty expires.

Staple your receipt here. Proof of the original purchase date is needed to obtain service under the warranty.

# Accessories

---

## Looking For Something More?

Café Appliances offers a variety of accessories to improve your cooking and maintenance experiences!

Refer to the Consumer Support page for phone numbers and website information.

The following products and more are available:

### Accessories

---

Small Broiler Pan (8 ¾" x 1 ¼" x 13 ½")

---

Large\* Broiler Pan (12 ¾" x 1 ¼" x 16 ½")

---

XL\*\* Broiler Pan (17" x 1 ¼" x 19 1/4")

---

### Parts

---

Oven racks

---

Oven elements

---

Light bulbs

---

Probe

---

### Cleaning Supplies

---

CitruShine™ Stainless Steel Wipes

---

Stainless Steel Appliance Cleaner

---

Graphite Lubricant

---

\*The large broiler pan does not fit in 20"/24" ranges.

\*\*The XL broiler pan does not fit in 24" wall ovens, 27" drop ins or 20"/24" ranges

**NOTES:** Go to the [cafeappliances.com](http://cafeappliances.com) to see recommended cleaners.

# Consumer Support

---

## Café Website

Have a question or need assistance with your appliance? Try the Café website 24 hours a day, any day of the year! You can also shop for more great Café products and take advantage of all our on-line support services designed for your convenience. In the US: [cafeappliances.com](http://cafeappliances.com)

---

## Register Your Appliance

Register your new appliance on-line at your convenience! Timely product registration will allow for enhanced communication and prompt service under the terms of your warranty, should the need arise. You may also mail in the pre-printed registration card included in the packing material. In the US: [cafeappliances.com/register](http://cafeappliances.com/register)

---

## Schedule Service

Expert Café repair service is only one step away from your door. Get on-line and schedule your service at your convenience any day of the year. In the US: [cafeappliances.com/service](http://cafeappliances.com/service)

---

## Extended Warranties

Purchase a Café extended warranty and learn about special discounts that are available while your warranty is still in effect. You can purchase it on-line anytime. Café Service will still be there after your warranty expires. In the US: [cafeappliances.com/extended-warranty](http://cafeappliances.com/extended-warranty)

---

## Remote Connectivity

For assistance with wireless network connectivity (for models with remote enable), visit our website at [cafeappliances.com/connect](http://cafeappliances.com/connect)

---

## Parts and Accessories

Individuals qualified to service their own appliances can have parts or accessories sent directly to their homes (VISA, MasterCard and Discover cards are accepted). Order on-line today 24 hours every day. In the US: [cafeappliances.com/parts](http://cafeappliances.com/parts)

**Instructions contained in this manual cover procedures to be performed by any user. Other servicing generally should be referred to qualified service personnel. Caution must be exercised, since improper servicing may cause unsafe operation.**

---

## Contact Us

If you are not satisfied with the service you receive from Café, contact us on our website with all the details including your phone number, or write to:

In the US: General Manager, Customer Relations | Café Appliances, Appliance Park | Louisville, KY 40225  
[cafeappliances.com/contact](http://cafeappliances.com/contact)