



Washers

Safety Instructions 2, 3

Operating Instructions

Controls 4-9

Features 10-11

Quick Start 5

Loading and Using the Washer ... 12-13

Care and Cleaning 14-17

Installation Instructions

Preparing to Install Your Washer 18

Location of Your Washer 19

Rough-In Dimensions 19

Unpacking Your Washer 20

Electrical Requirements 21

Grounding Requirements 21

Drain Requirements 22

Water Supply Requirements 22

Installing the Washer 23-24

Replacement Parts 24

Troubleshooting Tips 25-29

Consumer Support

Warranty (U.S.) 30

Warranty (Canada) 31

Consumer Support Back Cover



As an ENERGY STAR® partner, GE has determined that this product meets the ENERGY STAR® guidelines for energy efficiency.

Write the model and serial numbers here:

Model # _____

Serial # _____

You can find them on a label on the side of the washer.

Owner's Manual & Installation Instructions

- GFWS1705
- GFWS1700
- GFWS1605
- GFWS1600
- GFWH1200
- GFWN1100

Laveuses

Manuel d'utilisation et d'installation

La section français commence à la page 33

Lavadoras



Manual del propietario e instalación

La sección en español empieza en la página 65



IMPORTANT SAFETY INFORMATION. READ ALL INSTRUCTIONS BEFORE USING.

 This is the safety alert symbol. This symbol alerts you to potential hazards that can kill you or hurt you and others. All safety messages will follow the safety alert symbol and the word "DANGER", "WARNING", or "CAUTION". These words are defined as:

-  **DANGER** Indicates a hazardous situation which, if not avoided, **will** result in death or serious injury.
-  **WARNING** Indicates a hazardous situation which, if not avoided, **could** result in death or serious injury.
-  **CAUTION** Indicates a hazardous situation which, if not avoided, **could** result in minor or moderate injury.

IMPORTANT SAFETY INSTRUCTIONS

 **WARNING** To reduce the risk of death, fire, explosion, electric shock, or injury to persons when using your appliance, follow basic precautions, including the following:

- Read all instructions before using the appliance.
- DO NOT wash or dry articles that have been previously cleaned in, washed in, soaked in or spotted with gasoline, dry-cleaning solvents, or other flammable or explosive substances, as they give off vapors that could ignite or explode.
- DO NOT add gasoline, dry-cleaning solvents, or other flammable or explosive substances to the wash water. These substances give off vapors that could ignite or explode.
- Under certain conditions, hydrogen gas may be produced in a hot-water system that has not been used for 2 weeks or more. HYDROGEN GAS IS EXPLOSIVE. If the hot water system has not been used for such a period, before using a washing machine, turn on all hot-water faucets and let the water flow from each for several minutes. This will release any accumulated hydrogen gas. As the gas is flammable, DO NOT smoke or use an open flame during this time.
- DO NOT allow children to play on or in this appliance. Close supervision of children is necessary when this appliance is used near children. Before the washer is removed from service or discarded, remove the door or lid. Failure to follow these instructions may result in death or injury to persons.
- DO NOT reach into the appliance if the tub or agitator is moving to prevent accidental entanglement.
- DO NOT install or store this appliance where it will be exposed to the weather.
- DO NOT tamper with controls, repair or replace any part of this appliance or attempt any servicing unless specifically recommended in the user maintenance instructions or in published user repair instructions that you understand and have the skills to carry out.
- Keep the area around your appliance clean and dry to reduce the possibility of slipping.
- DO NOT operate this appliance if it is damaged, malfunctioning, partially disassembled, or has missing or broken parts including a damaged cord or plug.
- Unplug the appliance or turn off the circuit breaker before servicing. Pressing the **Power** button DOES NOT disconnect power.
- See "Electrical Requirements" located in the Installation Instructions for grounding instructions.

SAVE THESE INSTRUCTIONS

PROPER INSTALLATION



This washer must be properly installed and located in accordance with the Installation Instructions before it is used. If you did not receive an Installation Instructions, you can receive one by visiting GEAppliances.com or by calling 800.GE.CARES (800.432.2737). In Canada, visit www.geappliances.ca or call 800.561.3344.

- Ensure that the hot water hose is connected to the "H" (internal red screened) valve and the cold water hose is connected to the "C" (internal blue screened) valve.
- Install or store where it will not be exposed to temperatures below freezing or exposed to the weather, which could cause permanent damage and invalidate the warranty.
- Properly ground washer to conform with all governing codes and ordinances. Follow details in Installation Instructions.
- This washer does not include water supply hoses.

GE strongly recommends the use of factory specified parts. A list of factory hoses available for purchase are listed below. These hoses are manufactured and tested to meet GE specifications.

GE strongly recommends the use of new water supply hoses. Hoses degrade over time and need to be replaced every 5 years to reduce the risk of hose failures and water damage.

Parts and Accessories

Order on-line at GEApplianceparts.com today, 24 hours a day or by phone at 800.626.2002 during normal business hours. In Canada, call 800.661.1616.

Part Number	Accessory
PM14X10002	4 ft Rubber Water Supply Hoses
Or	
PM14X10005	4 ft Braided Metal Water Supply Hoses
WX10X10011	Tide® Washing Machine Cleaner*
PM7X1	Washer Floor Tray



WHEN NOT IN USE

- Turn off water faucets to minimize leakage if a break or rupture should occur. Check the condition of the fill hoses; GE recommends changing the hoses every 5 years.

SAVE THESE INSTRUCTIONS

About the washer control panel.

Throughout this manual, features and appearance may vary from your model.

You can locate your model number on a label on the side of the washer or inside the washer door.

Models: **GFWS1700 and GFWS1705** - Steam Washer with Time Saver

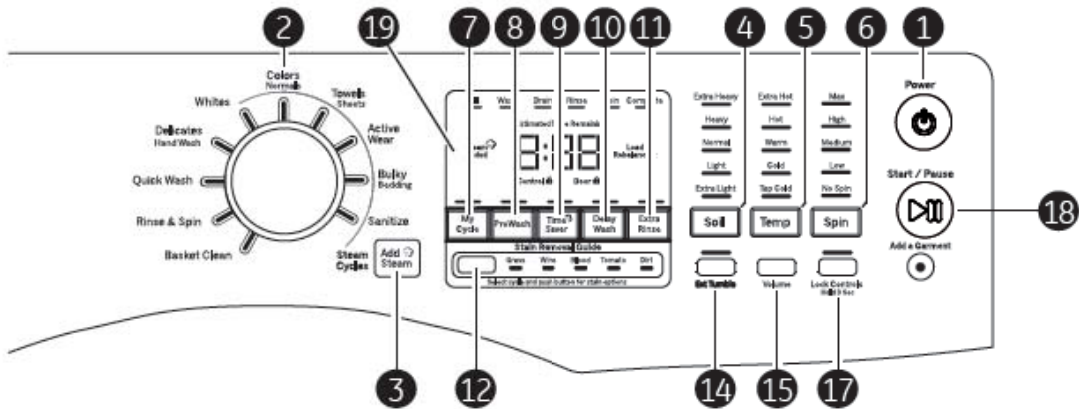

Models: **GFWS1600 and GFWS1605** - Steam Washer with Time Saver

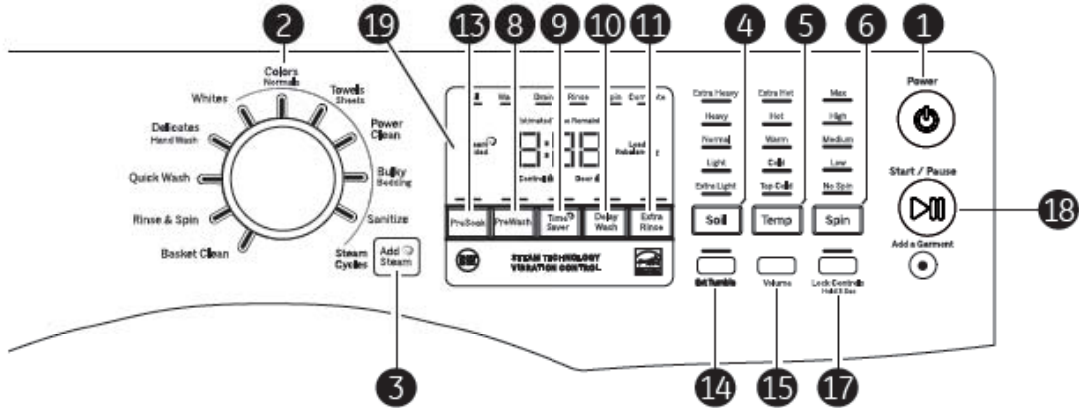

Model: **GFWH1200**

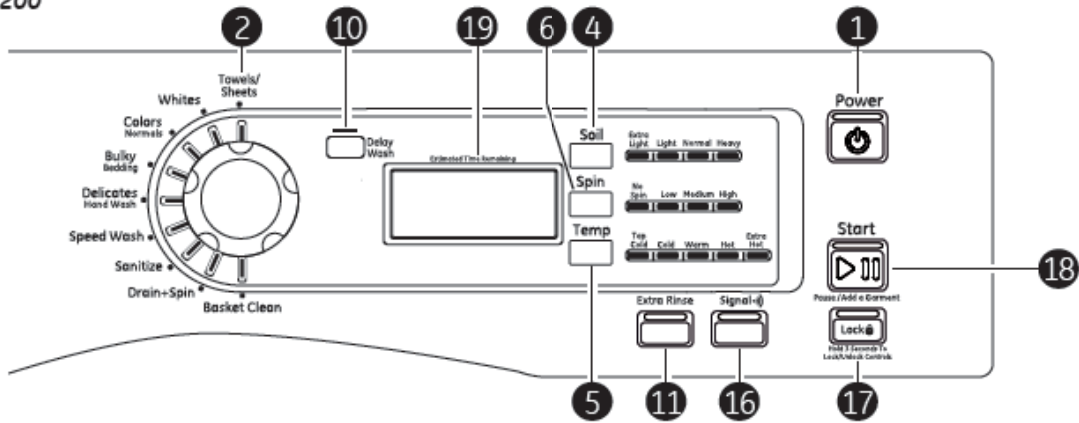

Model: **GFWN1100**

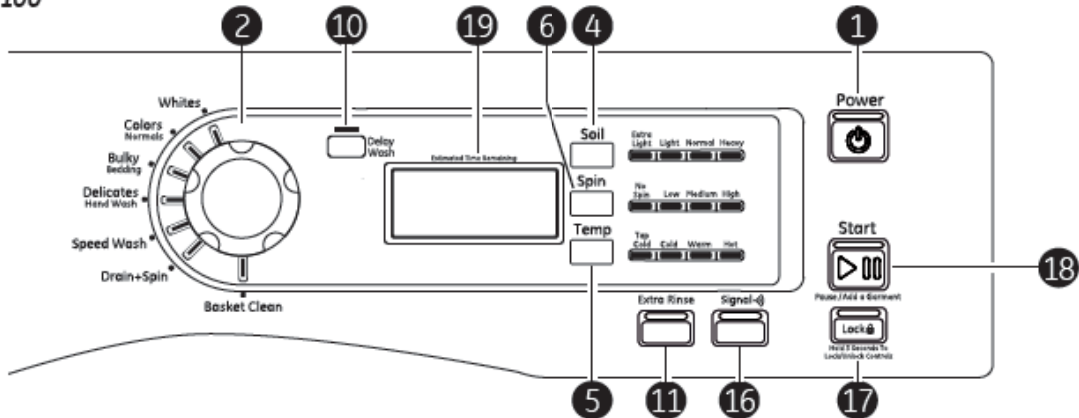

Control settings.

Quick Start

NOTE: Features and appearance vary by model.

1 Press the **Power** button.



If the screen is dark, a press of the **Power** button will "wake up" the display.

2 Select a wash cycle. (Defaults are set for each cycle. These default settings can be changed. See Control settings for more information.)

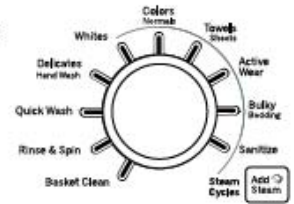

3 Press the **Start/Pause** button.



1 Power

Press to "wake up" the display. If the display is active, press to put the washer into standby mode.

NOTE: Pressing **Power** does not disconnect the appliance from the power supply.

2 Wash Cycles

The wash cycles are optimized for specific types of wash loads. The chart below will help you match the wash setting with the loads.

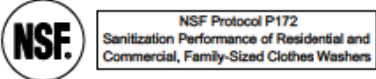
Colors/Normals*	For heavily to lightly soiled colorfast cottons, household linens, work and play clothes.
Whites*	For heavily to lightly soiled white laundry, work and play clothes.
Bulky/Bedding*	For large items such as comforters, blankets, small rugs and similar bulky items.
Active Wear* (on some models)	For active sports, exercise and some casual wear clothes. Fabrics include modern technology finishes and fibers such as spandex, stretch and micro-fibers.
Power Clean* (on some models)	For heavily soiled items which require extra cleaning power.
Sanitize* (on some models)	For increased water temperature which will sanitize and kill more than 99.9% of many common bacteria found in home laundry. For best results, select the extra heavy soil setting when using the Sanitize cycle.
	
Towels/Sheets* (on some models)	For items such as towels, sheets, pillowcases and dish rags.
Delicates/Hand Wash	For items labeled hand-washable with light soils. Provides gentle tumbling and soak during wash and rinse.
Speed Wash or Quick Wash	For lightly soiled items that are needed in a hurry. Cycle time is approximately 30 minutes, depending on selected options.
Rinse & Spin (on some models)	To quickly rinse and spin out any items at any time. To achieve a Drain + Spin, deselect the Extra Rinse option.
Drain + Spin (on some models)	To quickly drain and spin out any items at any time. To achieve a Rinse + Spin, select the Extra Rinse option.
Basket Clean	Use for cleaning the basket of residue and odor. Recommended use of at least once per month. NOTE: Never load laundry while using Basket Clean . The laundry may become damaged. See the Care and Cleaning section.

* The **Add Steam** option (on some models) can be used with these cycles.

Control settings.

3



Add Steam (on some models)

Add Steam adds steam into the washer to assist with loosening stains on the **Whites, Colors/Normal, Towels/Sheets, Active Wear** or **Power Clean** (depending on model), **Bulky Bedding** or **Sanitize** cycles.

To use:

1. Turn power **ON** and select a wash cycle.
2. Select the **Add Steam** button to activate steam.
3. Press the **Start/Pause** button.

4



Soil

Change the **Soil** level to increase or decrease the wash time to remove different amounts of soil.

To change the **Soil** level, press the **Soil** level button until you have reached the desired setting. You can choose between Extra Light, Light, Normal, Heavy or Extra Heavy soil levels.

5



Temp

Adjust to select the proper main water temperature for the wash cycle. The **PreSoak** and **PreWash** rinse water is always cold to help reduce energy usage and reduce setting of stains and wrinkles. Follow the fabric manufacturer's care label when selecting the wash temperature.

To change the wash temperature, press the wash **Temp** button until you have reached the desired setting. You can choose between Tap Cold, Cold, Warm, Hot or Extra Hot (Extra Hot is available on models equipped with a heater). By design, to protect fabrics, not all wash temperatures are available for certain wash cycles.

NOTE: The first 10 seconds of the wash fill is always cold. This feature assists in conditioning the fabric and preventing stains from setting on garments.

6



Spin

Changing the **Spin** speed changes the final spin speed of the cycles. Always follow the garment manufacturer's care label when changing the **Spin** speed.

To change the **Spin** speed, press the **Spin** speed button until you have reached the desired setting. You can choose between No Spin, Low, Medium, High or Max. Higher spin speeds are not available on certain cycles, such as **Delicates**.

Higher spin speeds remove more water from the clothes and will help reduce dry time, but may also increase the possibility of setting wrinkles on some fabrics.

7



My Cycle (on some models)

To save a favorite cycle, set the desired settings for wash cycle, soil level, spin speed and wash temp settings and hold down the **My Cycle** button for 3 seconds. A beep will sound to indicate the cycle has been saved.

To use your custom cycle, press the **My Cycle** button before washing a load.

To change the saved cycle, set the desired settings and hold down the **My Cycle** button for 3 seconds.

NOTE: When using **My Cycle**, wash options cannot be modified after the cycle has been started.

NOTE: If you change wash options with **My Cycle** before starting the cycle, the **My Cycle** light will turn off and you will be returned to the base cycle.



PreWash (on some models)

Prewash is an extra wash before the main wash. Use it for heavily soiled clothes or for clothes with a care label that recommends prewashing before washing. Be sure to add liquid or powder high-efficiency detergent, or the proper wash additive to the prewash dispenser.

PreWash must be selected prior to pressing **Start**.

The **PreWash** feature will fill the washer with cold water (adding the prewash detergent), tumble the clothes, drain and spin. Then the washer will run the selected wash cycle.

NOTE: In some special cycles, the prewash is selected automatically as the default. You can modify this selection at any time.



Time Saver (on some models)

Use this option to reduce the overall wash cycle by at least 20% without sacrificing wash performance. This feature is available on all cycles except **Basket Clean**, **Sanitize**, **Rinse + Spin**, and **Quick Wash**.

This option will modify the wash cycle, slightly raising the wash temperature and using more water to deliver equal wash performance as the basic cycle. All other features, such as **Extra Rinse**, **Add Steam**, etc. can be used with **Time Saver** but may adjust the total wash time.

To use:

1. Turn power on and select a wash cycle which has **Time Saver** as an option.
2. Make any adjustments to **Soil**, **Temp** and **Spin** as desired.
3. Press the **Time Saver** button to reduce the overall wash time.
4. Press the **Start/Pause** button.

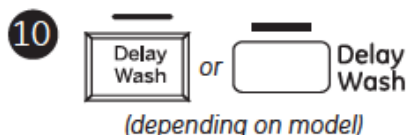

Delay Wash

You can delay the start of a wash cycle for up to 24 hours. Press the **Delay Wash** button to choose the amount of time you want to delay the start of the wash cycle. Once the desired time is reached, press the **Start** button. The machine will count down and start automatically at the correct time.

NOTE: If you forget to fully close the door, a reminder signal will beep reminding you to do so.

NOTE: If you open the door when the delay is counting down, the machine will enter the pause state. You must close the door and press **Start** again in order to restart the countdown.

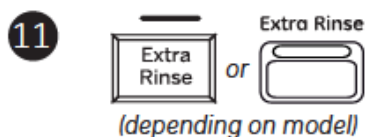

Extra Rinse

This option allows for an extra rinse during a cycle to remove excess dirt and detergent from soiled loads.

On models with **Rinse & Spin** cycle, a drain and spin cycle can be achieved by pressing the **Extra Rinse** button until the light is no longer illuminated.

On models with **Drain+Spin** cycle, a rinse and spin cycle can be achieved by selecting **Extra Rinse** option.

Control settings.

12

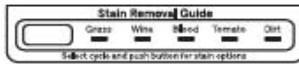

Stain Removal Guide

(on some models)

The **Stain Removal Guide** is pre-programmed with the ideal wash and rinse settings to tackle five common stains: grass, wine, blood, tomato and dirt. To use this feature, select the desired wash cycle and then press the **Stain Removal Guide** button until the stain you want to remove is highlighted. Once selected, press the **Start** button to start the cycle.

For some stains, a prewash will be selected automatically. Be sure to add liquid or powder high-efficiency detergent, or the proper wash additive to the prewash dispenser.

Add Steam cannot be selected when the **Stain Removal Guide** is used.

13



PreSoak (on some models)

For soaking your garments prior to the **PreWash** (if selected) and/or wash cycle. This option begins with a brief tumble and then proceeds to soak the clothes with cold water for a specified period of time. Once complete, the cycle will begin automatically.

PreSoak must be selected prior to pressing **Start**.

The **PreSoak** time is set in ½ hour increments, with the maximum presoak set option of 8 hours.

If desired, add high-efficiency detergent or the proper wash additive to the prewash dispenser.

14

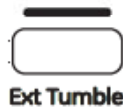

Extended Tumble (on some models)

Freshly tumbles your garments periodically for up to 8 hours after the wash cycle is complete to lessen the setting of wrinkles and creases when you are not able to move clothing to the dryer right away.

Note: The **Extended Tumble** option cannot be added to the **My Cycle** feature.

At the end of the cycle, the display will scroll "END" and after ten minutes the **Extended Tumble** will begin. It can be stopped at any time by pressing the **Power** button.

15



Volume

This button has two functions:

- To change the loudness of the end of cycle signal, press the button as many times as needed to reach the desired volume. There are four sound levels including OFF.

- To turn the button sounds ON/OFF, press and hold the button for 3 seconds.

16

Signal 



Cycle Signal

Use the **Signal** pad to change the volume of the end of cycle signal.

Press the pad until you reach the desired volume.

17

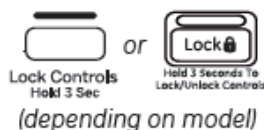

Lock Controls or Lock

(depending on model)

You can lock the controls to prevent any selections from being made. Or you can lock or unlock the controls after you have started a cycle.

Children cannot accidentally start the washer by touching buttons with this option selected.

To lock the washer, press and hold the **Lock Controls** or **Lock** button for 3 seconds.

To unlock the washer controls, press and hold the **Lock Controls** or **Lock** button for 3 seconds.

A sound is made to indicate the lock/unlock status.

The indicator light above the button will illuminate when the controls are locked.

NOTE: The **Power** button can still be used when the machine is locked.

18

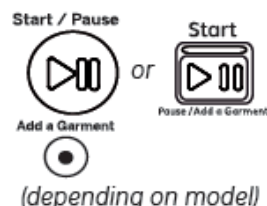

Start/Pause-Add A Garment

Press to start a wash cycle. If the washer is running, pressing it once will pause the washer and unlock the door. It will take a few seconds for the door to unlock after pressing **Pause**. Press again to restart the wash cycle.

NOTE: If the washer is paused and the cycle is not restarted within 15 minutes, the current wash cycle will be cancelled.

NOTE: In some cycles the washer will drain first, then unlock the door when it is paused.

NOTE: The washer performs automatic system checks after pressing the **Start** button. Water will flow in 45 seconds or less. You may hear the door lock and unlock before water flows; this is normal.

19



(appearance will vary and not all features on all models)

Display

Displays the approximate time remaining until the end of the cycle.

NOTE: The cycle time is affected by the water pressure in your home and the balance of the load in the washer. You may see the time remaining on the display increase to accommodate a slower spin speed to handle unbalanced loads.

On some models, cycle status is also displayed and certain features such as **Delay Wash** or **Steam** are shown indicating they have been selected.

About the washer features.

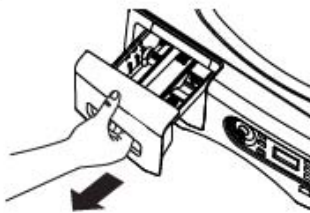

The Dispenser Drawer

Slowly open the dispenser drawer by pulling it out until it stops.

After adding laundry products, slowly close the dispenser drawer. Closing the drawer too quickly could result in early dispensing of the bleach, fabric softener or detergent.

You may see water in the dispenser drawer at the end of the cycle. This is a result of the flushing/siphoning action and is part of the normal operation of the washer.

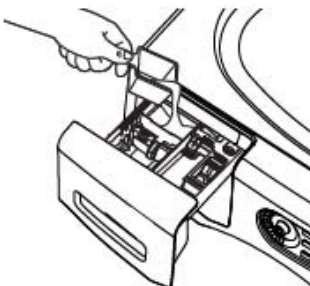

The Prewash Compartment (on some models)

■ Only use the Prewash Compartment if you are selecting the **Prewash** or **Presoak** cycle for heavily soiled clothes. Add measured detergent or prewash additive to the back left prewash compartment of the dispenser drawer.

■ Detergent or prewash additive is flushed from the dispenser in the prewash or Presoak cycle (if selected).

NOTE: Liquid detergent will drain into the washer drum as it is added.

■ Detergent usage may need to be adjusted for water temperature, water hardness, size and soil level of the load. Avoid using too much detergent in your washer as it can lead to over sudsing and detergent residue being left on the clothes.

The Detergent Compartment

■ **High-efficiency detergent is required for this washer. Use the detergent manufacturer's recommended amount.**

■ Add measured detergent to the front left detergent compartment of the dispenser drawer.

■ Detergent is flushed from the dispenser at the beginning of the wash cycle. Either powdered or liquid detergent can be used.

■ Detergent usage may need to be adjusted for water temperature, water hardness, size and soil level of the load. Avoid using too much detergent in your washer as it can lead to oversudsing and detergent residue being left on the clothes.

■ Using more detergent than the recommended quantity can cause residue buildup on your washer.

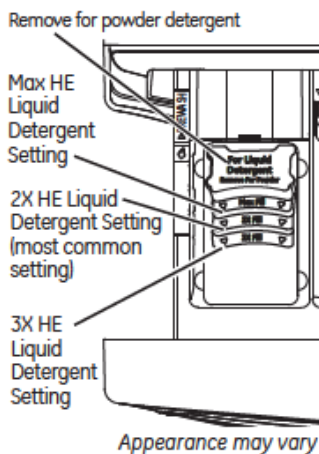

On models with a removable detergent cup

■ **Powder Detergent** – Remove the liquid detergent cup and place it in a safe location outside of the washer. Follow the detergent manufacturer's instructions when measuring the amount of powder to use.

■ **Liquid Detergent** – Locate the concentration of your detergent on the bottle. Do not fill above the Max Fill line in the detergent cup for your detergent concentration type.

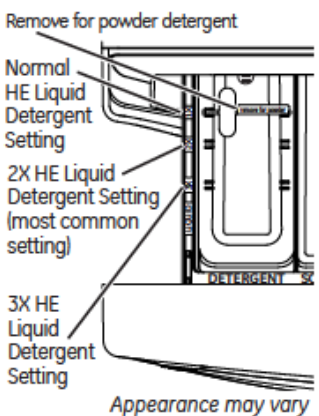

On models with a selection insert

The detergent selection insert must be placed in the detergent compartment in a specific position according to what type of detergent you are using.

■ **Powder Detergent** – Remove the detergent selection insert and place it in a safe location outside of the washer.

■ **Liquid Detergent** – You will need to adjust the insert according to the type of Liquid Detergent you are using. The icons on the side of the detergent compartment must line up on the center when the insert is in position.

NOTE: Not all models have the 2x and 3x detergent settings. Some have only regular HE detergent settings. You must reduce the amount of detergent for 2x or 3x detergent per bottle instructions.

Move the insert by pulling it up and replace it by sliding it down between either the rear or front detergent compartment molded rails, as desired, for liquid detergent. Remove for powder detergent.

Liquid detergent may seep under the insert prior to the start of the cycle. This is normal and will not affect the wash performance.

On some models:

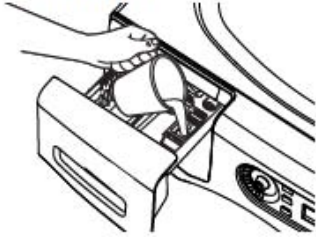

The Liquid Bleach Compartment

IMPORTANT: The bleach compartment position varies by model. Be sure to identify the correct compartment for bleach before using.

If desired, measure out the recommended amount of liquid bleach, not to exceed 1/3 cup (80 ml), and pour into the right compartment labeled "LIQUID BLEACH".

Do not exceed the maximum fill line. Overfilling can cause early dispensing of the bleach which could result in damaged clothes.

NOTE: Do not use powdered bleach in the dispenser.

On some models:

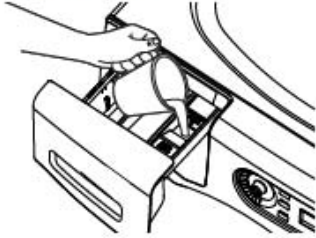

On some models:

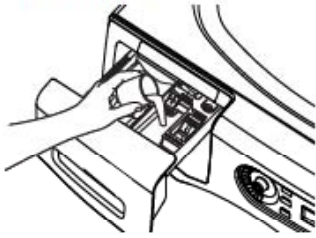

The Fabric Softener Compartment

IMPORTANT: The fabric softener compartment position varies by model. Be sure to identify the correct compartment for fabric softener before using.

If desired, pour the recommended amount of liquid fabric softener into the compartment labeled "FABRIC SOFTENER."

Use only liquid fabric softener in the dispenser.

Dilute with water to the maximum fill line.

Do not exceed the maximum fill line. Overfilling can cause early dispensing of the fabric softener which could stain clothes.

NOTE: Do not pour fabric softener directly on the wash load.

On some models:

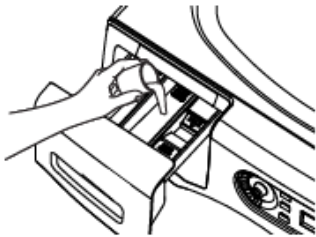

Loading and using the washer.

Always follow fabric manufacturer's care label when laundering.



Preparing Clothes

■ To avoid snags during washing:

Follow these steps to maximize garment care.

- Close garment zippers, snaps, buttons and hooks.
 - Mend seams, hems, tears.
 - Empty all items from pockets.
 - Remove nonwashable garment accessories such as ornaments and nonwashable trim materials.
- To avoid tangling, tie strings, draw ties and belt-like materials.
- Brush away surface dirt and lint; treat spots and stains.
 - Promptly wash wet or stained garments to maximize results.
 - Mix garments using recommended maximum load sizes on page 13.
 - Use nylon mesh garment bags to wash small items.
 - Wash multiple garments at one time for best results.



Fabric Care Labels

Below are fabric care label "symbols" that affect the clothing you will be laundering.

WASH LABELS

Machine wash cycle						
	Normal	Permanent Press/ wrinkle resistant	Gentle/ delicate	Hand wash	Do not wash	Do not wring
Water temperature						
	Hot (50°C/120°F)	Warm (40°C/105°F)	Cold/cool (30°C/85°F)			

BLEACH LABELS

Bleach symbols			
	Any bleach (when needed)	Only non-chlorine bleach (when needed)	Do not bleach

DETERGENT LABELS

	Use only HE High-Efficiency detergent.
--	--



Sorting Wash Loads

Colors	Soil	Fabric	Lint
Whites	Heavy	Delicates	Lint Producers
Lights	Normal	Easy Care	Lint Collectors
Darks	Light	Sturdy Cottons	

- Combine large and small items in a load. Load large items first. Large items should not be more than half the total wash load.
- Pillows and comforters should not be mixed with other items. This may cause an out-of-balance load.
- Sort dark-colored clothes from light-colored clothes to prevent dye transfer. This is a high-efficiency washer, so it uses less water, making dye transfer more common.

⚠ WARNING  - Fire Hazard

Never place items in the washer that are dampened with gasoline or other flammable liquids. No washer can completely remove oil. Do not dry anything that has ever had any type of oil on it (including cooking oils). Doing so can result in death, explosion, or fire.



Loading the Washer

The wash drum may be fully loaded with loosely added items. **Do not wash garments containing flammable materials (waxes, cleaning fluids, etc.).**

To add items after the washer has started, press **Start/Pause** and wait until the door is unlatched. The washer may take up to 30 seconds to unlock the door after pressing **Start/Pause**, depending on the machine conditions. Do not try to force the door open when it is locked. After the door unlocks, open gently. Add items, close the door and press **Start/Pause** to restart.

Loading Examples

WORKWEAR	LINENS	MIXED LOAD	DELICATES*	SPEED WASH (2-4 GARMENTS)
4 Jeans 5 Work Wear Shirts 5 Work Wear Pants	2 Bath Sheets 10 Bath Towels/ 12 Washcloths 7 Hand Towels/ 2 Terrycloth Bath Mats OR 2 Flat Queen-Sized Sheets 2 Fitted Queen-Sized Sheets 4 Pillowcases	4 Pillowcases 2 Hand Towels 2 Flat Sheets/ 2 Fitted Sheets 2 Bath Towels/ 4 Washcloths OR 6 Shirts (Men's or Women's) 4 Pair Pants (Khakis or Twills) 5 T-shirts 7 Pairs of Boxers 4 Pairs of Shorts OR 6 T-shirts 4 Pairs of Sweatpants 4 Sweatshirts 2 Hoodies 7 Pairs of Socks	7 Bras 7 Panties 3 Slips 2 Camisoles 4 Nightgowns *Using a nylon mesh bag for small items is recommended.	2 Casual Wear Work Shirts 1 Pair Casual Wear Work Pants OR 3 Soccer Uniforms

Care and Cleaning.

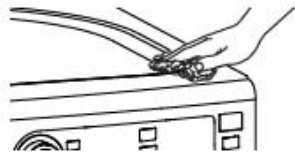

Exterior

Immediately wipe off any spills. Wipe with damp cloth. Do not hit surface with sharp objects.



Interior

To clean the interior of the washer, select the **Basket Clean** feature on the control panel. This **Basket Clean** cycle should be performed, at a minimum, once per month. This cycle will use more water, in addition to bleach, to control the rate at which soils and detergents may accumulate in your washer.

NOTE: Read the instructions below completely before starting the **Basket Clean** cycle.

1. Remove any garments or objects from the washer and ensure the washer basket is empty.
2. Open the washer door and pour one cup or 250 ml of liquid bleach or other washing machine cleaner into the basket.
3. Close the door and select the **Basket Clean** cycle. Push the **Start** pad.
4. When the **Basket Clean** cycle is working, the display will show the estimated cycle time remaining. The cycle will complete in about 90 minutes. Do not interrupt the cycle.
5. After the cycle is complete, leave the door open slightly for better ventilation.

If for any reason the cycle needs to be interrupted, the door will not open immediately. Forcing open the door at this stage may cause water to flood. The door will open after the water is drained to a level where it would not flood the floor.

Basket Clean may be interrupted by pressing the **Start** pad in between cycles. A power outage in the house might also interrupt the cycle. When the power supply is back, the **Basket Clean** cycle resumes where it had stopped. When interrupted, be sure to run a complete **Basket Clean** cycle before using the washer. If the **Power** pad is pressed during **BasketClean**, the cycle will be lost.

IMPORTANT:

- Run **Basket Clean** with 1 Cup (250 ml) of bleach once a month.
- After the completion of a **Basket Clean** cycle, the interior of your washer may have a bleach smell.
- It is recommended to run a light color load after the **Basket Clean** cycle.



Door Gasket

Open the washer door. Using both hands, press down the door gasket. Remove any foreign objects if found trapped inside the gasket. Make sure there is nothing blocking the holes behind the gasket.

While holding down the door gasket, inspect the interior gasket by pulling it down with your fingers. Remove any foreign objects if found trapped inside this gasket. Make sure there is nothing blocking the holes behind the gasket.

When you are finished cleaning the door gasket, remove your hands and the gasket will return to the operating position.



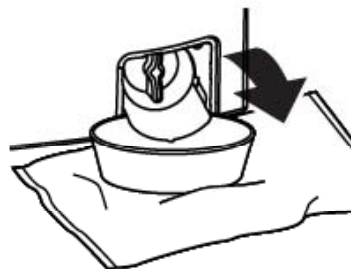

Cleaning the Pump Filter

Due to the nature of the front-load washer, it is sometimes possible for small articles to pass to the pump. The washer has a filter to capture lost items so they are not dumped to the drain. To retrieve lost items, clean out the pump filter.

1. Using a small flathead screwdriver or coin, open the access door.
2. Place a shallow pan or dish under the pump access door and towels on the floor in front of the washer to protect the floor. It is normal to catch about a quart of water when the filter is removed.

NOTE: If there is water in the basket when the pump filter is cleaned, it will drain out and a larger pan or dish may be necessary.

3. Pull down the pour spout.
4. Turn the pump filter counterclockwise and remove the filter slowly, controlling the flow of the draining water.
5. Clean the debris from the filter.
6. Replace the filter and turn clockwise. Tighten securely.
7. Flip up the pour spout.
8. Close the access door by hooking the bottom tabs first, then rotating the access door shut.

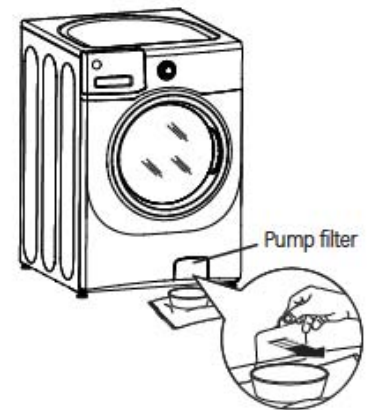

Care and Cleaning.

Tab on back right or left depending on model

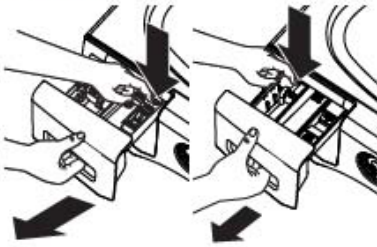

Lock tab is visible only after drawer has been pulled open

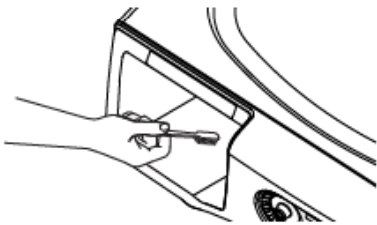
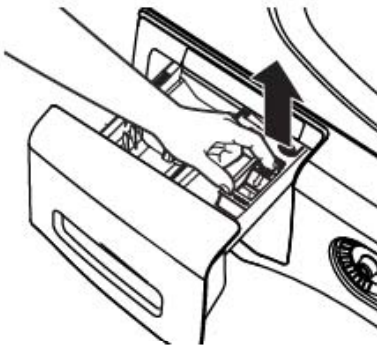

Dispenser Drawer Area

Detergent and fabric softener may build up in the dispenser drawer. Residue should be removed once or twice a month.

- Remove the drawer by first pulling it out until it stops. Then reach back into the left or right rear corner (depending on model) of the drawer cavity and press down firmly on the lock tab, pulling out the drawer.
- Remove the inserts from the bleach and fabric softener compartments and the detergent insert. Rinse the inserts and the drawer with very warm water to remove traces of accumulated laundry products.
- To clean the drawer opening, use a small brush to clean the recess. Remove all residue from the upper and lower parts of the recess.
- Return inserts to the proper compartments. Replace the dispenser drawer.
- To reduce buildup in the Dispenser Drawer area:

Use only HE
High-Efficiency
detergent.



Long Vacations

Be sure the water supply is shut off at the faucets. Drain all water from the hoses if the weather will be below freezing.

Moving and Storage

Ask the service technician to remove water from drain pump and hoses. Do not store the washer where it will be exposed to the weather. When moving the washer, the tub should be kept stationary by reinstalling the shipping bolts removed during installation. See Installation Instructions in this book. If these parts are not available, they can be ordered by visiting our Website at GEAppliances.com or by calling 800.GE.CARES. In Canada, call 800.561.3344.

Installation Instructions

Washer

If you have any questions, call 800.GE.CARES (800.432.2737)
or visit our Website at: GEAppliances.com
In Canada, call 1.800.561.3344 or visit www.GEAppliances.ca

! This is the safety alert symbol. This symbol alerts you to potential hazards that can kill you or hurt you and others. All safety messages will follow the safety alert symbol and the word "DANGER", "WARNING", or "CAUTION". These words are defined as:

! DANGER Indicates a hazardous situation which, if not avoided, will result in death or serious injury.

! WARNING Indicates a hazardous situation which, if not avoided, could result in death or serious injury.

! CAUTION Indicates a hazardous situation which, if not avoided, could result in minor or moderate injury.

BEFORE YOU BEGIN

Read these instructions completely and carefully.

- **IMPORTANT** – Save these instructions for local inspector's use.
- **IMPORTANT** – Observe all governing codes and ordinances.
- **Note to Installer** – Be sure to leave these instructions with the Consumer.
- **Note to Consumer** – Keep these instructions for future reference.
- **Skill level** – Installation of this appliance requires basic mechanical and electrical skills.
- **Completion time** – 1-3 hours
- Proper installation is the responsibility of the installer.
- Product failure due to improper installation is not covered under the Warranty.

PARTS SUPPLIED



Cable Tie



Inlet Hose Screen Washers (2)

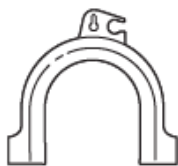

Hose Guide

TOOLS REQUIRED

- Adjustable wrench or 1/2" socket with ratchet
- Adjustable wrench or 9/16" open-end wrench
- Channel-lock adjustable pliers
- Carpenter's level

PARTS REQUIRED (Obtain locally)

- Water Hoses (2)



STACK BRACKET KIT

A stack bracket kit is available at additional cost. It can be ordered in the United States by visiting our Web site at GEAppliances.com or calling 800.GE.CARES. In Canada, call 800.661.1616 or visit your local GE Appliances dealer. Order kit # WE25X10018 or GEFLSTACK.

OPTIONAL PEDESTAL ACCESSORY

A pedestal is available at additional cost. It can be ordered in the United States by visiting our Web site at GEAppliances.com or calling 800.GE.CARES. In Canada, visit your local GE Appliances dealer. This product should be used with the pedestal # SBSC137HXX, SBSD137HXX and SBSD227FX. Follow the pedestal Installation Instructions.

Installation Instructions

LOCATION OF YOUR WASHER

Do Not Install the Washer:

1. In an area exposed to dripping water or outside weather conditions. The ambient temperature should never be below 60°F (15.6°C) for proper washer operation.
2. In an area where it will come in contact with curtains or drapes.
3. On carpet. The floor **MUST** be a hard level surface with a maximum slope of 1/2" per foot (1.27 cm per 30 cm). To make sure the washer does not vibrate or move, you may have to reinforce the floor.

NOTE: If the floor is in poor condition, use 3/4" impregnated plywood sheet solidly attached to the existing floor covering.

IMPORTANT:

Minimum Installation Clearances

- When installed in alcove: Sides, Rear, Top = 0" (0 cm)
- When installed in closet: Sides, Rear, Top = 0" (0 cm), Front = 1" (2.54 cm)
- Closet door ventilation openings required: 2 louvers each 60 square in. (387 cm), located 3" (7.6 cm) from top and bottom of door

ROUGH-IN DIMENSIONS

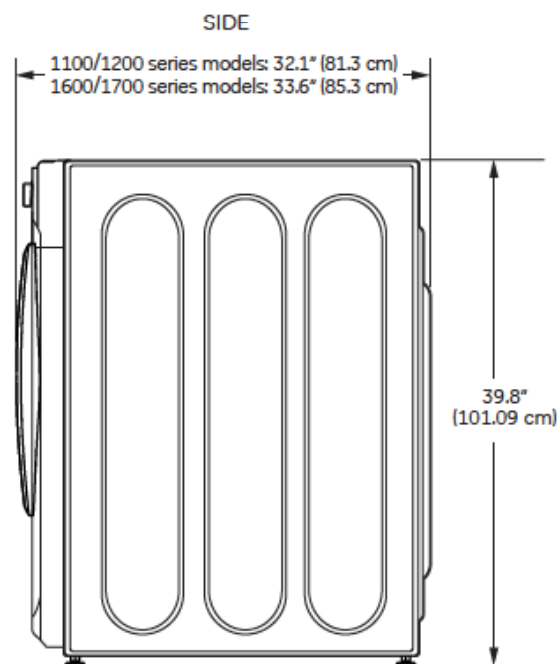
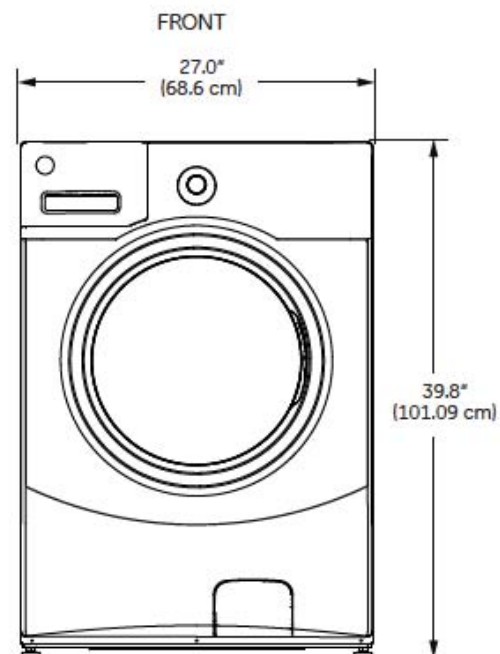

NOTE: With pedestal, 52.6"
Stacked, 84"

Installation Instructions

UNPACKING THE WASHER

⚠ WARNING: Recycle or destroy the carton and plastic bags after the washer is unpacked. Make materials inaccessible to children. Children might use them for play. Cartons covered with rugs, bedspreads or plastic sheets can become airtight chambers causing suffocation.

1. Cut and remove the top and bottom packaging straps.
2. While it is in the carton, carefully lay the washer on its side. **DO NOT** lay the washer on its front or back.
3. Turn down the bottom flaps—remove all base packaging, including the cardboard, styrofoam base and styrofoam tub support (inserted in center of base).

NOTE: If you are installing a pedestal, proceed to the installation instructions that come with the pedestal.

4. Carefully return the washer to an upright position and remove the carton.
5. Carefully move the washer to within 4 feet (122 cm) of the final location.



6. Remove the following from the back side of the washer:
 - 4 bolts
 - 4 plastic spacers (including rubber grommets)
 - 4 power cord retainers

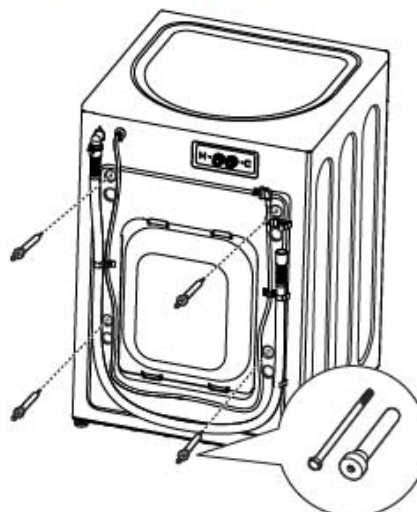

NOTE: Failure to remove the shipping braces can cause the washer to become severely unbalanced.

Save all bolts for future use.

NOTE: If you must transport the washer at a later date, you must reinstall the shipping support hardware to prevent shipping damage. Keep the hardware in the plastic bag provided.

In case you misplace your shipping bolts, replacements are available at additional cost. They can be ordered in the United States by visiting our website at GEAppliances.com or calling 800.GE.CARES. In Canada, call 800.661.1616. Order kit #WH49X10039.

Installation Instructions

ELECTRICAL REQUIREMENTS

WARNING - Fire Hazard

Plug into a grounded 3-prong outlet.

DO NOT remove ground prong.

DO NOT use an adapter.

DO NOT use an extension cord.

Failure to follow these instructions can result in death, fire or electrical shock.

CIRCUIT – Individual, properly polarized and grounded 15 or 20 amp circuit breaker or time-delay fuse.

POWER SUPPLY – 2 wire plus ground, 120 Volt, single phase, 60 Hz, alternating current.

Outlet Receptacle – Properly grounded 3-prong receptacle to be located so the power cord is accessible when the washer is in an installed position. If a 2-prong receptacle is present, it is the owner's responsibility to have a licensed electrician replace it with a properly grounded 3-prong grounding type receptacle.



Washer must be electrically grounded in accordance with local codes and ordinances, or in the absence of local codes, in accordance with the NATIONAL ELECTRICAL CODE, ANSI/NFPA NO. 70 latest edition. Check with a licensed electrician if you are not sure that the washer is properly grounded.

GROUNDING INSTRUCTIONS

This appliance must be grounded. In the event of malfunction or breakdown, grounding will reduce the risk of electric shock by providing a path of least resistance for electric current. This appliance is equipped with a cord having an equipment-grounding conductor and a grounding plug. The plug must be plugged into an appropriate outlet that is properly installed and grounded in accordance with all local codes and ordinances.

 **WARNING** Improper connection of the equipment-grounding conductor can result in a risk of electrical shock. Check with a qualified electrician, or service representative or personnel, if you are in doubt as to whether the appliance is properly grounded. **DO NOT** modify the plug on the power supply cord. If it will not fit the outlet, have a proper outlet installed by a qualified electrician.

If required by local codes, an external 18 gauge or larger copper ground wire (not provided) may be added. Attach to washer cabinet with a #8-18 x 1/2" sheet metal screw (available at any hardware store) to rear of washer.

Mobile Home Installation:

Installation must conform to Standard for Mobile Homes, ANSI A119.1 and National Mobile Home Construction and Safety Standards Act of 1974 (PL93-383).

Installation Instructions

WATER SUPPLY REQUIREMENTS

Hot and cold water faucets MUST be installed within 42 inches (107 cm) of your washer's water inlet. The faucets MUST be 3/4" (1.9 cm) garden hose-type so inlet hoses can be connected. Water pressure MUST be between 10 and 120 pounds per square inch. Your water department can advise you of your water pressure. The hot water temperature should be set to deliver water at 120° to 140°F (48°–60°C).

DRAIN REQUIREMENTS

1. Drain capable of eliminating 17 gals (64.3 L) per minute.
2. A standpipe diameter of 1–1/4" (3.18 cm) minimum.
3. The standpipe height above the floor should be:
Minimum height: 24" (61 cm)
Maximum height: 96" (244 cm)

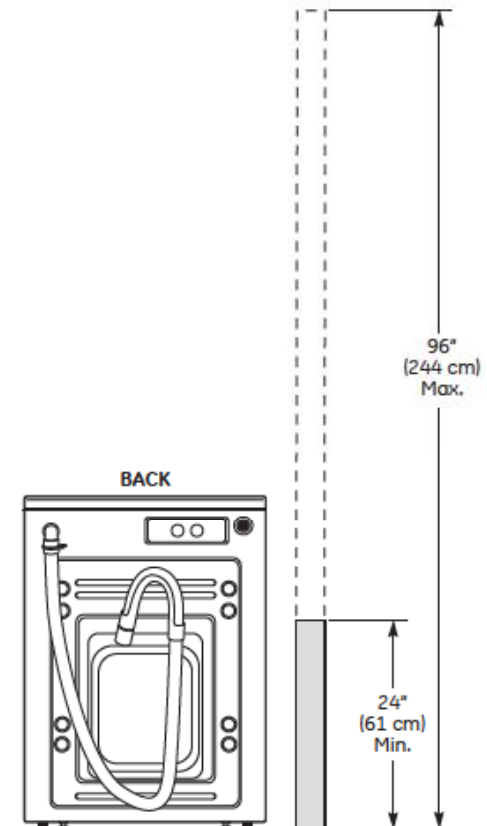

NOTE: The drain hose attached to the washer can reach a 58" (147 cm) high standpipe. For a higher standpipe, contact an authorized parts distributor.

Installation Instructions

INSTALLING THE WASHER

1. Run some water from the hot and cold faucets to flush the water lines and remove particles that might clog up the inlet hoses and water valve screens.

2. Obtain inlet hoses locally.

3. Ensure there is a rubber washer in the hoses. Reinstall the rubber washer into the hose fitting if it has fallen out during shipment. Carefully connect an inlet hose to the outside "H" outlet of the water valve. Tighten by hand, then tighten another 2/3 turn with pliers. Carefully connect the other inlet hose to the inside "C" outlet of the water valve. Tighten by hand; then tighten another 2/3 turn with pliers. **Do not crossthread or over-tighten these connections.**



4. Install the screen washers by inserting them into the free ends of the inlet hoses with protruded side facing the faucet.

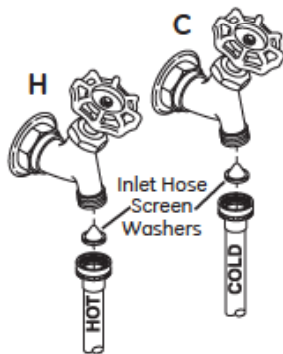

5. Connect the inlet hose ends to the HOT and COLD water faucets tightly by hand, then tighten another 2/3 turn with pliers. Turn the water on and check for leaks.



6. Carefully move the washer to its final location. Gently rock the washer into position ensuring inlet hoses do not become kinked. It is important not to damage the rubber leveling legs when moving your washer to its final location. Damaged legs can increase washer vibration. It may be helpful to spray window cleaner on the floor to help move your washer into its final position. **NOTE:** To reduce vibration, ensure that all four rubber leveling legs are firmly touching the floor. Push and pull on the back right and then back left of your washer.

NOTE: Do not use the dispenser drawer or door to lift the washer.

NOTE: If you are installing into a drain pan, you can use a 24-inch long 2x4 to lever the washer into place.

7. With the washer in its final position, place a level on top of the washer (if the washer is installed under a counter, the washer should not be able to rock). Adjust the front leveling legs up or down to ensure the washer is resting solid. Turn the lock nuts on each leg up towards the base of the washer and snug with a wrench.



NOTE: Keep the leg extension at a minimum to prevent excessive vibration. The farther out the legs are extended, the more the washer will vibrate.

If the floor is not level or is damaged, you may have to extend the rear leveling legs.



Installation Instructions

INSTALLING THE WASHER (cont.)

8. Attach the U-shaped hose guide to the end of the drain hose. Place the hose in a laundry tub or standpipe and secure it with the cable tie provided in the enclosure package.

NOTE: Placing the drain hose too far down the drain pipe can cause a siphoning action. No more than 7 inches of hose should be in the drain pipe. There must be an air gap around the drain hose. A snug fit can also cause a siphoning action.

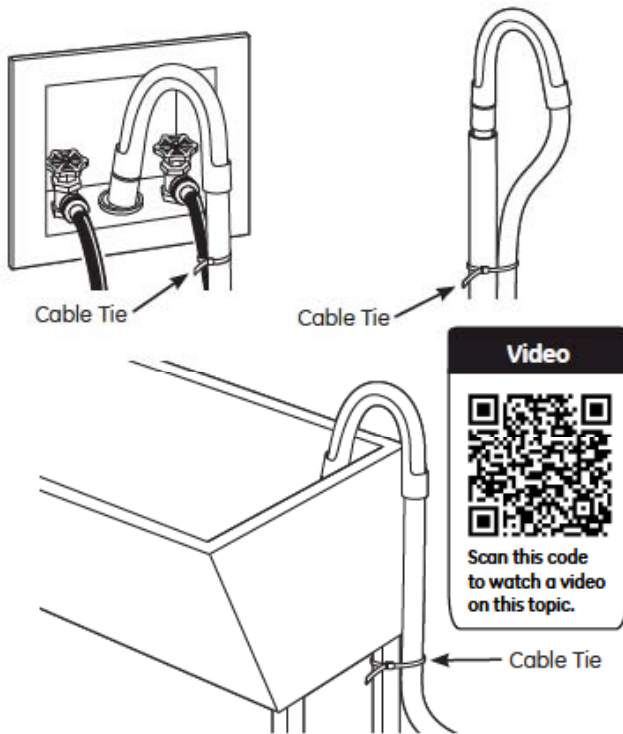

9. Plug the power cord into a grounded outlet.

NOTE: Check to be sure the power is off at the circuit breaker/fuse box before plugging the power cord into an outlet.

10. Turn on the power at the circuit breaker/fuse box.

11. Read the rest of this Owner's Manual. It contains valuable and helpful information that will save you time and money.

12. Before starting the washer, check to make sure:

- Main power is turned on.
- The washer is plugged in.
- The water faucets are turned on.
- The unit is level and all four leveling legs are firmly on the floor.
- The shipping support hardware is removed and saved.
- The drain hose is properly tied up.
- There are no leaks at the faucet, drain line or washer.

13. Run the washer through a complete cycle. Check for water leaks and proper operation.

14. If your washer does not operate, please review the *Before You Call For Service* section before calling for service.

15. Place these instructions in a location near the washer for future reference.

REPLACEMENT PARTS

If replacement parts are needed for your washer, they can be ordered in the United States by visiting our Web site at GEAppliances.com or by calling 800.GE.CARES. In Canada, call 800.661.1616.

Truth or myth?

Below is a list of truths and myths to help you better understand your frontload washer		
Truth or Myth?	Answer	Explanation
There is not enough water to properly wash my clothes	MYTH	Since frontload washers do not require the tub to fill with water, significantly less water is required to thoroughly wash and rinse each load. Except for certain cycles like Delicates/Handwash and Basket Clean that use more water, you will not see a visible water line on the door glass.
My frontload washer may add time or run longer than the original displayed time.	TRUE	Occasionally, the washer may need to add more time to the cycle. This is mainly due to automatic load redistributions to better balance the load and reduce vibration. It is normal operation for the washer to add time to the cycle to rebalance the load. Common causes of out-of-balance loads or longer cycle times are a clogged pump filter (see the Care and Cleaning section), un-level washer, or exceeding the recommended maximum load sizes.
I should see suds/foam during a wash cycle in the frontload washer.	MYTH	HE detergents, which should be the only detergents used in your GE frontload washer, have been formulated to clean effectively without causing a build-up of suds. If you add detergent until a visible suds/foam level is reached, you may be using too much detergent and negatively impacting washer performance. Remember, more suds/foam does not equal more cleaning power. Follow the manufacturer's directions for HE detergent. 
It is best to wash full loads and like fabrics together.	TRUE	Wash multiple similar garments at one time for best results. Washing single items can cause an out-of-balance condition.
I need to keep the washer level for proper operation and to reduce vibration.	TRUE	If the washer is uneven, adjust the leveling legs so that they are firmly touching the floor and the lock nuts are securely tightened. This is especially important if the washer is installed on a pedestal. Leveling the legs on the washer or the pedestal require the same steps.
It is impossible to overload a frontload washer.	MYTH	Although the capacity of the frontload washer allows for larger loads than a traditional topload washer, care must be taken to not overload the wash basket. See the Loading and Using the Washer section for recommended maximum load sizes. Overloading the washer can lead to reduced wash performance and clothes becoming trapped between the door glass and the gasket, possibly causing damage to your gasket or your clothes.
If not periodically cleaned, my wash basket and gasket may not maintain a fresh smell.	TRUE	This is true for all washers, not just frontload. Regularly run a Basket Clean cycle and clean around the rubber door gasket. When not in use, you may leave the door slightly open for the inside of the washer to air dry. Close supervision is necessary if this appliance is used by or near children.
Frontload washers have a "pump filter" that needs to be cleaned periodically.	TRUE	Due to the nature of the frontload washer, it is sometimes possible for small articles to pass to the drain pump. The washer has a filter to capture lost items so they do not damage the drain pump. To retrieve lost items, clean out the pump filter (see the Care and Cleaning section). Indicators of a clogged pump are long drain and cycle times, wet clothes at the end of a cycle, incomplete cycles or washer pausing in the middle of a cycle.
I cannot add items to a wash cycle once it has started.	MYTH	To add items after the washer has started, press Start/Pause - Add a Garment button and wait until the door is unlocked. The drain pump may run briefly before door is unlocked. Do not try to force open the door when it is locked. After the door unlocks, open gently. Add items, close the door and press Start/Pause to restart.
Items left in pockets can cause damage to the rubber door gasket	TRUE	This is true for all frontload washers. Remove all loose items from your clothes.

Before you call for service...



Troubleshooting Tips
Save time and money! Review the charts on the following pages first and you may not need to call for service.

Problem	Possible Cause	What To Do
Not draining Not spinning Not tumbling	Load is out of balance Pump clogged Drain hose is kinked or improperly connected Household drain may be clogged Drain hose siphoning; drain hose pushed too far down the drain	<ul style="list-style-type: none"> • Redistribute clothes and run drain & spin or rinse & spin. • Increase load size if washing small load containing heavy and light items. • See page 15 on how to clean the Pump Filter. • Straighten drain hose and make sure washer is not sitting on it. • Check household plumbing. You may need to call a plumber. • Ensure there is an air gap between hose and drain.
Leaking water	Door gasket is damaged Check back left of washer for water Fill hoses or drain hose is improperly connected Household drain may be clogged Dispenser clogged Incorrect use of detergent Dispenser box cracked	<ul style="list-style-type: none"> • Check to see if gasket is seated and not torn. Objects left in pockets may cause damage to the washer (nails, screws, pens, pencils) • Water may drip from the door when the door is opened. This is a normal operation. • Carefully wipe off rubber door seal. Sometimes dirt or clothing is left in this seal and can cause a small leak • If this area is wet, you have oversudsing condition. Use less detergent. • Make sure hose connections are tight at washer and faucets and make sure end of drain hose is correctly inserted in and secured to drain facility. • Check household plumbing. You may need to call a plumber. • Powder soap may cause clogs inside the dispenser and cause water to leak out the front of the dispenser. Remove drawer and clean both drawer and inside of dispenser box. Please refer to <i>Cleaning the Washer</i> section. • Use only HE and correct amount of detergent. • If new installation, check for crack on inside of dispenser box.
Clothes too wet	Load is out of balance Pump clogged Overloading Drain hose is kinked or improperly connected Household drain may be clogged Drain hose siphoning; drain hose pushed too far down the drain	<ul style="list-style-type: none"> • Redistribute clothes and run drain & spin or rinse & spin. • Increase load size if washing small load containing heavy and light items. • The machine will slow the spin speed down to 410 rpm if it has a hard time balancing the load. This speed is normal. • See page 15 on how to clean the Pump Filter. • The dry weight of the load should be less than 16 lbs. • Straighten drain hose and make sure washer is not sitting on it. • Check household plumbing. You may need to call a plumber. • Ensure there is an air gap between hose and drain.

Problem	Possible Cause	What To Do
<i>Incomplete cycle or timer not advancing</i>	<p>Automatic load redistribution</p> <p>Pump clogged</p> <p>Drain hose is kinked or improperly connected</p> <p>Household drain may be clogged</p> <p>Drain hose siphoning; drain hose pushed too far down the drain</p>	<ul style="list-style-type: none"> • Timer adds 3 minutes to cycle for each rebalance. 11 or 15 rebalances may be done. This is normal operation. Do nothing; the machine will finish the wash cycle. • See page 15 on how to clean the Pump Filter. • Straighten drain hose and make sure washer is not sitting on it. • Check household plumbing. You may need to call a plumber. • Ensure there is an air gap between hose and drain.
<i>Loud or unusual noise; vibration or shaking</i>	<p>Cabinet moving</p> <p>All rubber leveling legs are not firmly touching the floor</p> <p>Unbalanced load</p> <p>Pump clogged</p>	<ul style="list-style-type: none"> • Washer is designed to move 1/4" to reduce forces transmitted to the floor. This movement is normal. • Push and pull on the back right and then back left of your washer to check if it is level. If the washer is uneven, adjust the rubber leveling legs so they are all firmly touching the floor and locked in place. Your installer should correct this problem. • Pause unit, open door and manually redistribute load. To check machine, run rinse and spin with no load. If normal, unbalance was caused by load. • See page 15 on how to clean the Pump Filter.
<i>No power/ washer not working or dead</i>	<p>Washer is unplugged</p> <p>Water supply is turned off</p> <p>Circuit breaker/fuse is tripped/ blown</p> <p>Automatic self system checks</p>	<ul style="list-style-type: none"> • Make sure cord is plugged securely into a working outlet. • Turn both hot and cold faucets fully on. • Check house circuit breakers/fuses. Replace fuses or reset breaker. Washer should have separate outlet. • First time the washer is plugged in, automatic checks occur. It may take up to 20 seconds before you can use your washer. This is normal operation.
<i>Snags, holes, tears, rips or excessive wear</i>	<p>Overloaded</p> <p>Pens, pencils, nails, screws or other objects left in pockets</p> <p>Pins, snaps, hooks, sharp buttons, belt buckles, zippers and sharp objects left in pockets</p>	<ul style="list-style-type: none"> • Do not exceed maximum recommended load sizes. See recommended maximum load sizes on page 13. • Remove loose items from pockets. • Fasten snaps, hooks, buttons and zippers.
<i>Control time wrong or changes</i>	<p>This is normal</p>	<ul style="list-style-type: none"> • During spin the washer may need to rebalance the load sometimes to reduce vibrations. When this happens, the estimated time is increased causing time left to increase or jump.
<i>Not enough water</i>	<p>This is normal</p>	<ul style="list-style-type: none"> • Horizontal washers do not require the tub to fill with water like top-load washers.
<i>Washer pauses or has to be restarted, or washer door is locked and will not open</i>	<p>Pump clogged</p>	<ul style="list-style-type: none"> • See page 15 on how to clean the Pump Filter.
<i>Door unlocks or press Start and machine doesn't operate</i>	<p>This is normal</p> <p>Incorrect operation</p>	<ul style="list-style-type: none"> • Front-load washers start up differently than top-load washers, and it takes 30 seconds to check the system. The door will lock and unlock. • Simply open and close the door firmly; then press Start.

Before you call for service...

Problem	Possible Cause	What To Do
<i>Water does not enter washer or enters slowly</i>	<p>Automatic self system checks</p> <p>Water supply is turned off</p> <p>Water valve screens are stopped up</p> <p>Inlet hose screen washers are stopped up</p>	<ul style="list-style-type: none"> • After Start is pressed, the washer does several system checks. Water will flow 60 seconds after Start is pressed. • Turn on both hot and cold faucets fully. • Turn off the water source and remove the water connection hoses from the upper back of the washer. Use a brush or toothpick to clean the screens in the machine. Reconnect the hoses and turn the water back on. • Turn off the water source and remove the inlet hoses from the wall faucets. Use a brush or toothpick to clean the screen washers in the end of the hoses. Reconnect the hoses and turn the water back on.
<i>Wrinkling</i>	<p>Improper sorting</p> <p>Overloading</p> <p>Incorrect wash cycle</p> <p>Repeated washing in water that is too hot</p>	<ul style="list-style-type: none"> • Avoid mixing heavy items (like work clothes) with light items (like blouses). • Load your washer so clothes have enough room to move freely. • Match cycle selection to the type of fabric you are washing (especially for easy care loads). • Wash in warm or cold water.
<i>Grayed or yellowed clothes</i>	<p>Not enough detergent</p> <p>Not using HE (high efficiency) detergent</p> <p>Hard water</p> <p>Water is not hot enough</p> <p>Detergent is not dissolving</p> <p>Dye transfer</p>	<ul style="list-style-type: none"> • Use correct amount of detergent. • Use only HE detergent. • Use hottest water safe for fabric. • Use a water conditioner like Calgon brand or install a water softener. • Make sure water heater is delivering water at 120°–140°F (48°–60°C). • Try a liquid HE detergent. • Sort clothes by color. If fabric label states wash separately, unstable dyes may be indicated.
<i>Colored spots</i>	<p>Incorrect use of fabric softener</p> <p>Dye transfer</p>	<ul style="list-style-type: none"> • Check fabric softener package for instructions and follow directions for using dispenser. • Sort whites or lightly colored items from dark colors. • Promptly remove wash load from washer.
<i>Water temperature is incorrect</i>	<p>Water supply is improperly connected</p> <p>House water heater is not set properly</p>	<ul style="list-style-type: none"> • Make sure hoses are connected to correct faucets. • Make sure house water heater is delivering water at 120°–140°F (48°–60°C).
<i>Slight variation in metallic color</i>	<p>This is normal</p>	<ul style="list-style-type: none"> • Due to the metallic properties of paint used for this unique product, slight variations of color may occur due to viewing angles and lighting conditions.
<i>Bad odor inside your Washer</i>	<p>Washer unused for a long time, not using recommended quality of HE detergent or used too much detergent</p>	<ul style="list-style-type: none"> • Run a Basket Clean cycle. • In case of strong odor, you may need to run the Basket Clean cycle more than once. • Use only the amount of detergent recommended on the detergent container. • Use only HE (high efficiency) detergent. • Always remove wet items from the washer promptly after machine stops running. • Leave the door slightly open for the water to air dry. Close supervision is necessary if this appliance is used by or near children. Do not allow children to play on or in this or any other appliance.

Problem	Possible Cause	What To Do
<i>Detergent leak</i>	<p>Incorrect placement of detergent insert</p> <p>This is normal</p>	<ul style="list-style-type: none"> • Make sure detergent insert is properly located and fully seated. Never put detergent above max line. • It is normal operation to see detergent leak on door gasket about 20 seconds after filling the dispenser.
<i>Improper dispensing of softener or bleach</i>	<p>Dispenser clogged</p> <p>Softener or bleach is filled above the max line</p> <p>Softener or bleach cap issue</p>	<ul style="list-style-type: none"> • Monthly clean the dispenser drawer to remove buildup of chemicals. • Make sure to have the correct amount of softener or bleach. • Make sure softener and bleach cap for dispenser are seated or they will not work.
<i>Dispenser drawer not dispensing properly</i>	Laundry detergent packet placed in dispenser drawer	<ul style="list-style-type: none"> • Laundry detergent packets should not be used in the dispenser. They should only be added directly to the wash basket following the manufacturer's directions.
<i>Pump running while washer is not in use</i>	Clog in sump drain	<ul style="list-style-type: none"> • This is normal. Drain sump is detecting an undesired water fill level from a potential open faucet. Shut off water valve and inspect water valve for blockage.

GE Washer Warranty. *(For customers in the United States)*



All warranty service provided by our Factory Service Centers, or an authorized Customer Care® technician. To schedule service, on-line, visit us at GEAppliances.com, or call 800.GE.CARES (800.432.2737). Please have serial number and model number available when calling for service.

Staple your receipt here. Proof of the original purchase date is needed to obtain service under the warranty.

For The Period Of: We Will Replace:

One Year

From the date of the original purchase

Any part of the washer which fails due to a defect in materials or workmanship. During this **limited one-year warranty**, GE will also provide, **free of charge**, all labor and related service costs to replace the defective part.

What Is Not Covered (in the United States):

- Service trips to your home to teach you how to use the product.
- Improper installation, delivery or maintenance.
- Failure of the product if it is abused, misused, or used for other than the intended purpose or used commercially.
- Replacement of house fuses or resetting of circuit breakers.
- Products which are not defective or broken, or which are working as described in the Owner's Manual.
- Damage to the product caused by accident, fire, floods or acts of God.
- Incidental or consequential damage caused by possible defects with this appliance.
- Defects or damage due to operation in freezing temperatures.
- Damage after delivery.
- Product not accessible to provide required service.

EXCLUSION OF IMPLIED WARRANTIES—Your sole and exclusive remedy is product repair as provided in this Limited Warranty. Any implied warranties, including the implied warranties of merchantability or fitness for a particular purpose, are limited to one year or the shortest period allowed by law.

This warranty is extended to the original purchaser and any succeeding owner for products purchased for home use within the USA. If the product is located in an area where service by a GE Authorized Servicer is not available, you may be responsible for a trip charge or you may be required to bring the product to an Authorized GE Service location for service. In Alaska, the warranty excludes the cost of shipping or service calls to your home.

Some states do not allow the exclusion or limitation of incidental or consequential damages. This warranty gives you specific legal rights, and you may also have other rights which vary from state to state. To know what your legal rights are, consult your local or state consumer affairs office or your state's Attorney General.

Warrantor: General Electric Company, Louisville, KY 40225

GE Washer Warranty. (For customers in Canada)



All warranty service provided by our Factory Service Centres or an authorized technician. For service, call 1.800.561.3344.

Please have serial number and model number available when calling for service.

For The Period Of: We Will Replace:

One Year

From the date of the original purchase

Any part of the washer which fails due to a defect in materials or workmanship. During this **limited one-year warranty**, GE will also provide, **free of charge**, all labour and related service costs to replace the defective part.

What Is Not Covered (in Canada):

- Service trips to your home to teach you how to use the product.
- Improper installation, delivery or maintenance.
- Failure of the product if it is abused, misused, or used for other than the intended purpose or used commercially.
- Replacement of house fuses or resetting of circuit breakers.
- Products which are not defective or broken, or which are working as described in the Owner's Manual.
- Damage to the product caused by accident, fire, floods or acts of God.
- Incidental or consequential damage caused by possible defects with this appliance.
- Defects or damage due to operation in freezing temperatures.
- Damage after delivery.
- Product not accessible to provide required service.

EXCLUSION OF IMPLIED WARRANTIES—Your sole and exclusive remedy is product repair as provided in this Limited Warranty. Any implied warranties, including the implied warranties of merchantability or fitness for a particular purpose, are limited to one year or the shortest period allowed by law.

This warranty is extended to the original purchaser and any succeeding owner for products purchased in Canada for home use within Canada. In-home warranty service will be provided in areas where it is available and deemed reasonable by MC Commercial to provide.

WARRANTOR IS NOT RESPONSIBLE FOR CONSEQUENTIAL DAMAGES.

Warrantor: MC COMMERCIAL, BURLINGTON, ON, L7T 3R6

Notes.
