



# Electric Coil & Radiant RANGES

*Safety Information*.....2-6

***Operating Instructions***

Surface Units.....7-8  
 Cookware..... 9  
 Controls..... 10  
 Oven..... 11, 12  
 Clock, Timer and  
 Convenience Outlet..... 13, 14  
 Timed Baking and Roasting..... 15  
 Special Features..... 16-18  
 Sabbath Features..... 19, 20  
 Temperature Conversions..... 20  
 Thermostat..... 21  
 Self Clean..... 22, 23

*Care and Cleaning*.....24-30

*Installation Instructions*.....31-35

*Troubleshooting Tips*.....36-40

*Accessories*..... 41

***Consumer Support***

Product Registration..... 42, 43  
 Warranty..... 44  
 Consumer Support..... 45

**Owner's Manual and  
Installation Instructions**

**Coil Top and  
Radiant Top Models**

Standard Clean Models	Self-Clean Models
JCAS745	JCAP750
JCAS445	JCAP760
	JCAP765

**Write the model and serial  
numbers here:**

**Model #** \_\_\_\_\_

**Serial #** \_\_\_\_\_

You can find them on a label,  
behind the storage drawer on the  
oven frame.



## IMPORTANT SAFETY INFORMATION. READ ALL INSTRUCTIONS BEFORE USING.

### **⚠ WARNING!**

For your safety, the information in this manual must be followed to minimize the risk of fire or explosion, electric shock, or to prevent property damage, personal injury, or loss of life.



### **⚠ WARNING ANTI-TIP DEVICE**

#### **All ranges can tip and injury could result.**

To prevent accidental tipping of the range, attach it to the wall by installing the Anti-tip device supplied.

If the Anti-Tip device supplied with the range does not fit this application, use the universal Anti-Tip device WB2X7909

To check if the device is installed and engaged properly, carefully tip the range forward. The Anti-Tip device should engage and prevent the range from tipping over.

If you pull the range out from the wall for any reason, make sure the device is properly engaged when you push the range back against the wall. If it is not, there is a possible risk of the range tipping over and causing injury if you or a child stand, sit or lean on an open door.

Please refer to the Anti-Tip device information in this manual. Failure to take this precaution could result in tipping of the range and injury.



## SAFETY PRECAUTIONS

When using electrical appliances, basic safety precautions should be followed, including the following:

- Use this appliance only for its intended purpose as described in this Owner's Manual.
- Be sure your appliance is properly installed and grounded by a qualified technician in accordance with the provided installation instructions.
- Do not attempt to repair or replace any part of your range unless it is specifically recommended in this manual. All other servicing should be referred to a qualified technician.
- BEFORE PERFORMING ANY SERVICE, DISCONNECT THE RANGE POWER SUPPLY AT THE HOUSEHOLD DISTRIBUTION PANEL BY REMOVING THE FUSE OR SWITCHING OFF THE CIRCUIT BREAKER.
- Do not leave children alone—children should not be left alone or unattended in an area where an appliance is in use. They should never be allowed to sit or stand on any part of the appliance.
- Do not allow anyone to climb, stand or hang on the door, storage drawer, or cooktop. They could damage the range and even tip it oven, causing severe personal injury.
- Do not store flammable materials in an oven or near the cooktop.
- **CAUTION:** ITEMS OF INTEREST TO CHILDREN SHOULD NOT BE STORED IN CABINETS ABOVE A RANGE OR ON THE BACKSPLASH OF A RANGE—CHILDREN CLIMBING ON THE RANGE TO REACH ITEMS COULD BE SERIOUSLY INJURED.



## COOK MEAT AND POULTRY THOROUGHLY...

Cook meat and poultry thoroughly—meat to at least an INTERNAL temperature of 160° F and poultry to at least an INTERNAL temperature of 180°F. Cooking to these temperatures usually protects against foodborne illness.



## ⚠ WARNING! SAFETY PRECAUTIONS

- Never wear loose-fitting or hanging garments while using the appliance. Be careful when reaching for items stored over the range. Flammable material could be ignited if brought in contact with hot surface units or heating elements and may cause severe burns.
  - Use only dry pot holders—moist or damp pot holders on hot surfaces may result in burns from steam. Do not let pot holders touch hot surface units or heating elements. Do not use a towel or other bulky cloth.
  - For your safety never use your appliance for warming or heating the room.
  - Do not let cooking grease or other flammable materials accumulate in or near the range.
  - Do not use water on grease fires. Never pick up a flaming pan. Turn the controls off. Smother a flaming pan on a surface unit by covering the pan completely with a well-fitting lid, cookie sheet or flat tray. Use a multi-purpose dry chemical or foam-type fire extinguisher.
- Flaming grease outside a pan can be put out by covering it with baking soda or, if available, by using a multi-purpose dry chemical or foam-type fire extinguisher.
- Flame in the oven can be smothered completely by closing the door and turning the oven off or by using a multi-purpose dry chemical or foam-type fire extinguisher.
- Do not touch the surface units, the heating elements or the interior surface of the oven. These surfaces may be hot enough to burn even though they are dark in color. During and after use, do not touch or let clothing or other flammable materials contact, the surface units, areas nearby the surface units or any interior area of the oven; allow sufficient time for cooling first.
- Potentially hot surfaces include the cooktop, areas facing the cooktop, oven vent opening, surfaces near the opening, crevices around the oven door and metal trim parts above the door.
- REMEMBER:** The inside surface of the oven may be hot when the door is opened.
- Do not store or use combustible materials, gasoline or other flammable vapors and liquids in the vicinity of this or any other appliance.
  - Keep the hood and grease filters clean to maintain good venting and to avoid grease fires.
  - NEVER BLOCK the vents (air openings) of the range. They provide the air inlet and outlet that are necessary for the range to operate properly with correct combustion. Air openings are located at the rear of the cooktop, at the top and bottom of the oven door, and at the bottom of the range under the storage drawer.

## IMPORTANT SAFETY INFORMATION. READ ALL INSTRUCTIONS BEFORE USING.

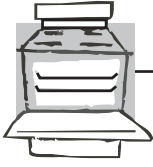

### OVEN

- Stand away from the range when opening the oven door. Hot air or steam which escapes can cause burns to hands, face and/or eyes.
- Do not heat unopened food containers. Pressure could build up and the container could burst, causing an injury.
- Keep the oven vent unobstructed.
- Keep the oven free from grease buildup.
- Place the oven shelf in the desired position while the oven is cool. If shelves must be handled when hot, do not let pot holder contact the heating elements.
- Pulling out the shelf to the stop-lock is a convenience in lifting heavy foods. It is also a precaution against burns from touching hot surfaces of the door or oven walls.
- When using cooking or roasting bags in the oven, follow the manufacturer's directions.
- Do not use the oven to dry newspapers. If overheated, they can catch on fire.
- Do not use the oven for a storage area. Items stored in an oven can ignite.
- Do not leave paper products, cooking utensils or food in the oven when not in use.

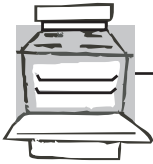

### SELF-CLEANING OVEN *(on some models)*

- Do not clean the door gasket. The door gasket is essential for a good seal. Care should be taken not to rub, damage or move the gasket.
- Clean only parts listed in this Owner's Manual.
- Do not use oven cleaners on self-clean models. No commercial oven cleaner or oven liner protective coating of any kind should be used in or around any part of the oven. Residue from oven cleaners will damage the inside of the oven when the self-clean cycle is used.
- Before self-cleaning the oven, remove the broiler pan, grid and other cookware.
- Be sure to wipe up excess spillage before starting the self-cleaning operation.
- If the self-cleaning mode malfunctions, turn the oven off and disconnect the power supply. Have it serviced by a qualified technician.
- Take the shelves out of the oven before you begin the self-clean cycle or they may discolor.



## SURFACE UNITS-ALL MODELS

*Use proper pan size-select cookware having flat bottoms large enough to cover the surface unit heating element. The use of undersized cookware will expose a portion of the surface unit to direct contact and may result ignition of clothing. Proper relationship of cookware to surface unit will also improve efficiency.*

- Never leave the surface units unattended at high beat settings. Boilovers cause smoking and greasy spillovers that may catch on fire.
- Only certain types of glass, glass/ceramic, earthenware or other glazed containers are suitable for cooktop service, others may break because of the sudden change in temperature.
- To minimize the possibility of burns, ignition of flammable materials and spillage, the handle of a container should be turned toward the center of the range without extending over nearby surface units.
- Always turn the surface units off before removing cookware.
- Do not flame foods on the cooktop. If you do flame foods under the hood, turn the fan on.
- Keep an eye on foods being fried at high or medium high heat settings.
- Foods for frying should be as dry as possible. Frost on frozen foods or moisture on fresh foods can cause hot fat to bubble up and over the side of the pan.
- Use little fat for effective shallow or deep fat frying. Filling the pan too full of fat can cause spillovers when food is added.
- If a combination of oils or fats will be used in frying, stir together before heating, or as fats melt slowly.
- Always heat fat slowly, and watch as it heats.
- Use a deep fat thermometer whenever possible to prevent overheating fat beyond the smoking point.

## IMPORTANT SAFETY INFORMATION. READ ALL INSTRUCTIONS BEFORE USING.



### **▲ WARNING!** RADIANT SURFACE UNITS *(on some models)*

Use care when touching the cooktop. The glass surface of the cooktop will retain heat after the controls have been turned off.

- Avoid scratching the glass cooktop. The cooktop can be scratched with items such as sharp instruments, rings or other jewelry and rivets on clothing.
  - Large scratches or impacts to glass doors or cooktops can lead to broken or shattered glass.
  - Do not operate the radiant surface units if the glass is broken. Spillovers or cleaning solution may penetrate a broken cooktop and create a risk of electrical shock. Contact a qualified technician immediately should your glass cooktop become broken.
  - Never use glass cooktop surface as a cutting board.
  - Do not place or store items that can melt or catch fire on the glass cooktop, even when it is not being used.
  - Be careful when placing spoons or other stirring utensils on the glass cooktop surface when it is in use. They may become hot and could cause burns.
  - Clean the cooktop with caution. If a wet sponge or cloth is used to wipe spills on a hot surface unit, be careful to avoid steam burns. Some cleaners can produce noxious fumes if applied to a hot surface.
- NOTE:** We recommend that you avoid wiping any surface unit areas until they have cooled and the indicator light has gone off. Sugar spills are the exception to this. Please see **Cleaning the glass cooktop** section.
- When the cooktop is cool, use only the recommended cleaning cream to clean the cooktop.
  - To avoid possible damage to the cooking surface, do not apply cleaning cream to the glass surface when it is hot.
  - After cleaning, use a dry cloth or paper towel to remove all cleaning cream residue.
  - Read and follow all instructions and warnings on the cleaning cream labels.
  - Do not lift the cooktop. Lifting the cooktop can lead to damage and improper operation of the range.



### **▲ WARNING!** COIL SURFACE UNITS *(on some models)*

- Clean the cooktop with caution. If a wet sponge is used to wipe spills on a hot cooktop, be careful to avoid steam burns.
- To avoid the possibility of a burn or electric shock, always be certain that the controls for all surface units are at the OFF position and all coils are cool before attempting to lift or remove a unit.
- Do not immerse or soak the removable surface units. Do not put them in a dishwasher.
- Be sure the drip pans and the vent duct are not covered and are in place. Their absence during cooking could damage range parts and wiring.
- Do not use aluminum foil to line the drip pans or anywhere in the oven except as described in this manual. Misuse could result in a shock, fire hazard or damage to the range.



**READ AND FOLLOW THIS SAFETY INFORMATION CAREFULLY**  
**SAVE THESE INSTRUCTIONS**

# Using the surface units.

Throughout this manual, features and appearance may vary from your model.

## Surface Cooking Controls

Your surface units and controls are designed to give you a variety of heat settings for surface unit cooking.

At both **LO** and **HI** positions, there is a slight niche so control **clicks** at those positions; **HI** marks the highest setting; **LO**, the lowest setting.

In a quiet kitchen, you may hear slight **clicking** sounds during cooking, indicating heat settings selected are being maintained.

Switching heats to higher settings always shows a quicker change in temperature than switching to lower settings.

## How to Set the Controls

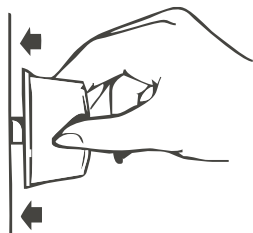

- 1 Push the control knob in.
- 2 Turn either clockwise or counterclockwise to desired heat setting.

Control must be pushed in to set only from the **OFF** position.

When control is in any position other than **OFF**, you can turn it without pushing in.

Be sure you turn control to **OFF** when you finish cooking. An indicator light will glow when **ANY** surface unit is on.

A Burner On indicator light will glow when **ANY** surface unit is on.

## Heat Setting Guide

**MAX** --- Quick start for cooking; bring water to boil.

**MEDIUM HIGH** --- Fast fry, pan broil; maintain fast boil on large amount of food.

**MED** --- Sauce and brown; maintain slow boil on large amount of food.

**MEDIUM LOW** --- Cereal; maintain serving temperature of most foods.

**MIN** --- Cook after starting at **HI**; cook with little water in covered pan. Use to steam rice.

### NOTE:

- 1 At **MAX** or **MEDIUM HIGH**, never leave food unattended. Boilovers cause smoking; greasy spillovers may catch fire.
- 2 At **MIN**, melt chocolate, butter on small unit.

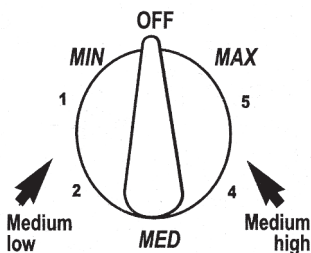

## Cooking Tips

Use medium- or heavyweight cookware. Aluminum cookware conducts heat faster than other metals. Cast-iron and coated cast-iron cookware is slow to absorb heat, but generally cooks evenly at low or medium heat settings. Steel pans may cook unevenly if not combined with other metals.

Do not overfill cookware with fat that may spill over when adding food. Frosty foods bubble vigorously. Watch foods frying at high temperatures. Keep range and hood clean from accumulated grease.

To conserve the most cooking energy, pans should be flat on the bottom, have straight side and tight-fitting lids. Match the size of the saucepan to the size of the surface unit. A pan that extends more than an inch beyond the edge of the drip pan traps heat, which causes "crazing" (fine hairline cracks) on porcelain, and discoloration ranging from blue to dark gray on chrome drip pans.

## Using the surface units.

Throughout this manual, features and appearance may vary from your model.

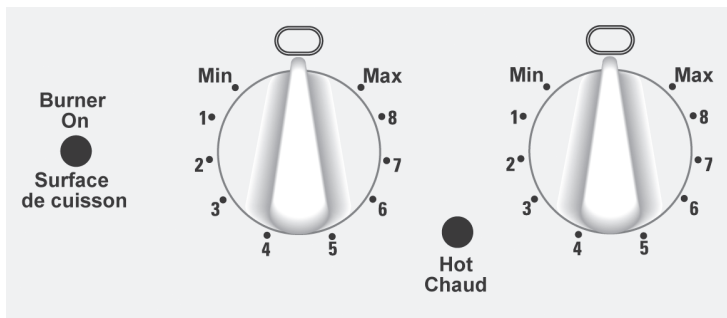

### Indicator Lights (on radiant glass models only).

A **Hot** indicator light will glow when any radiant element is turned on, and will remain on until the surface is cool enough to touch.

A **Burner On** indicator light will glow when any surface unit is on.

**NOTE:** The **Hot** indicator light may glow between the surface control settings of **Min** and **OFF**, but there is no power to the surface units.

## Using the radiant surface units. (on some models)



Never cook directly on the glass. Always use cookware.



Always place the pan in the center of the surface unit you are cooking on.

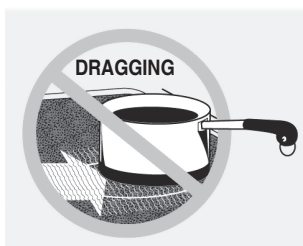

### About the radiant surface units...

The radiant cooktop features heating units beneath a smooth glass surface.

**NOTE:** A slight odor is normal when a new cooktop is used for the first time. It is caused by the heating of new parts and insulating materials and will disappear in a short time.

The surface unit will cycle on and off to maintain your selected control setting.

It is safe to place hot cookware from the oven or surface on the glass surface when the surface is cool.

Even after the surface units are turned off, the glass cooktop retains enough heat to continue cooking. To avoid over-cooking, remove pans from the surface units when the food is cooked. Avoid placing anything on the surface unit until it has cooled completely.

Do not slide cookware across the cooktop because it can scratch the glass --- the glass is scratch resistant, not scratch proof.

- Water stains (mineral deposits) are removable using the cleaning cream or full-strength white vinegar.
- Use of window cleaner may leave an iridescent film on the cooktop. The cleaning cream will remove this discoloration.
- Don't store heavy items above the cooktop. If they drop onto the cooktop, they can cause damage.
- Do not use the surface as a cutting board.

### Temperature Limiter

Every radiant surface unit has a temperature limiter.

The temperature limiter protects the glass cooktop from getting too hot.

The temperature limiter may cycle the units off for a time if:

- The pan boils dry.
- The pan bottom is not flat.
- The pan is off center.
- There is no pan on the unit.



# Selecting types of cookware.

The following information will help you choose cookware will give good performance on glass cooktops.

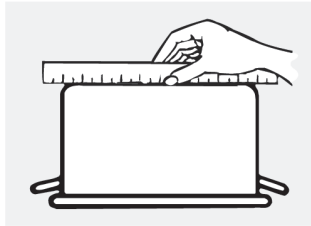

Check for flat bottoms by using a straight edge.

**Stainless Steel:**  
recommended

**Aluminum:**  
heavy weight recommended.

Good conductivity. Aluminum residues sometimes appear as scratches on the cooktop, but can be removed if cleaned immediately. Because of its low melting point, thin-weight aluminum should not be used.

**Glass-ceramic:**  
usable, but not recommended  
Poor performance. May scratch the surface.

**Stoneware:**  
usable, but not recommended  
Poor performance. May scratch the surface.

**Home Canning Tips:**  
Be sure the canner is centered over the surface unit.  
Make sure the canner is flat on the bottom.  
Use recipes and procedures from reputable sources. These are available from manufacturers such as Ball® and Kerr® and the Department of Agriculture Extension Service.  
To prevent burns from steam or heat, use caution when canning.



Pans with rounded, curved, ridged or warped bottoms are not recommended.

**Copper Bottom:**  
recommended

Copper may leave residues which can appear as scratches. The residues can be removed, as long as the cooktop is cleaned immediately. However, do not let these pots boil dry. Overheated metal can bond to glass cooktops. An overheated copper bottom pot will leave a residue that will permanently stain the cooktop if not removed immediately.

**Porcelain Enamel Covered Cast Iron:**  
recommended

As long as the cookware is covered completely with porcelain enamel, this cookware is recommended. Caution is recommended for cast-iron cookware that is not completely covered with smooth porcelain enamel, as it may scratch the glass-ceramic cooktop.

The following information will help you choose cookware which will give food performance on coil cooktops.

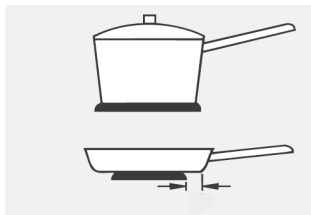

Not over 1 inch

## Surface Cookware Tips

Use medium- or heavy-weight cookware. Aluminum cookware conducts heat faster than other metals. Cast-iron and coated cast-iron cookware are slow to absorb heat, but generally cook evenly at low to medium heat settings. Steel pans may cook unevenly if not combined with other metals.

For best cooking results, pans should be flat on the bottom. Match the size of the saucepan to the size of the surface unit. The pan should not extend over the edge of the surface unit than 1 inch.

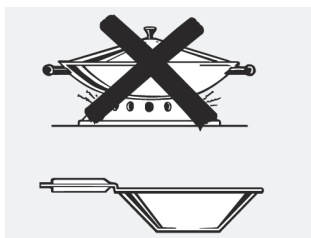

Use Only flat-bottomed woks.

## Wok Cooking

We recommend that you use only a flat-bottomed wok. They are available at your local retail store.

Do not use woks that have support rings. Use of these types of woks, with or without the ring in place, can be dangerous.

Placing the ring over the surface unit will cause a buildup of heat that will damage the porcelain cooktop. Do not try to use such woks without the ring. You could be seriously burned if the wok tips over.

## Using the oven controls. (on some models)

Throughout this manual, features and appearance may vary from your model.

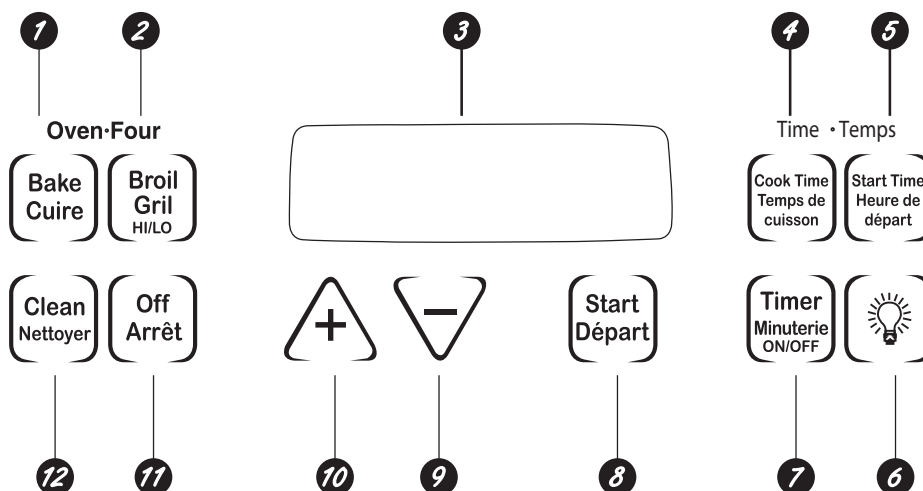

### Oven Control, Clock and Timer Features and Settings



- 1** **BAKE** Pad  
Touch this pad to select the bake function.  
**BAKE** Light  
Flashes while in edit mode---you can change the oven temperature this point.
- 2** **BROIL HI/LO** Pad  
Touch this pad to select the broil function.  
**BROIL** Light  
Flashes while in edit mode---you can switch from **HI** to **LO BROIL** at this point.
- 3** **Display**  
Shows the operations you have selected, the time of day and the cooking status.
- 4** **COOK TIME** Pad  
Touch this pad and then touch the + or - pad to set the amount of time you want your food to cook. The oven will shut off when the cooking time has run out.
- 5** **START TIME** Pad  
Use along with the **COOK TIME** or **SELF CLEAN** pad to set the oven to start and stop automatically at a time you set.
- 6** **OVEN LIGHT ON/OFF** Pad  
Touch this pad to turn the oven light on or off.
- 7** **TIMER/CLOCK** Pad  
Touch this pad to select the timer feature. Then press + and - pads to adjust time.  
To set the clock, touch this pad and hold 3 seconds and then touch the + and - pads. The time of day will flash in the display when the oven is first turned on.
- 8** **START** Pad  
Must be touched to start any cooking function.
- 9** **-** Pad  
Short taps to this pad will decrease the time or temperature by small amounts. Touch and hold the pad to decrease the time or temperature by larger amounts.
- 10** **+** Pad  
Short taps to this pad will increase the time or temperature by small amounts. Touch and hold the pad to increase the time or temperature by larger amounts.
- 11** **CLEAR/OFF** Pad  
Touch this pad to cancel **ALL** oven operations except the clock and timer.
- 12** **SELF CLEAN** Pad  
Touch this pad to select the self-cleaning function. **See the Using the self-cleaning oven** section.  
**CLEAN** Light  
Flashes while in edit mode---you can change the length of time for the self-clean cycle at this point. Glows when the oven is in the self-clean cycle. After the self-clean cycle, the light will turn off. Unlatch the door.

If "F- and a number or letter" flash in the display and the oven control signals, this indicates a function error code.

Touch the **CLEAR/OFF** pad. Allow the oven to cool for one hour. Put the oven back into operation.

If function error code repeats, disconnect power to the oven and call for service.

# Using the oven.

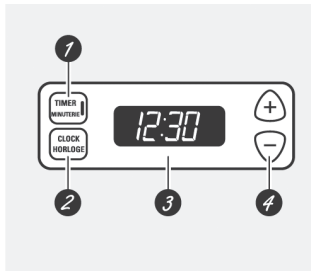

Appearance may vary.

## Clock and Timer (on some models)

- 1** **TIMER Pad**  
Touch this pad to select the timer feature.
- 2** **CLOCK Pad**  
Touch this pad before setting the clock.
- 3** **Display**  
Shows the time of day and the time set for the timer, cook time or start time.
- 4** **SET +/- Pads**  
These pads allow you to set the clock and timer.

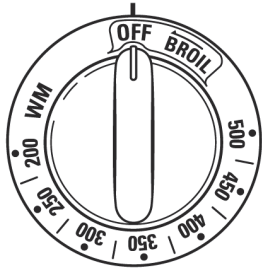

## Oven Temperature Knob (on some models)

- Turn this knob to the setting you want.
- The oven cycling light glows until the oven reaches your selected temperature, then goes off and on with the oven element(s) during cooking.

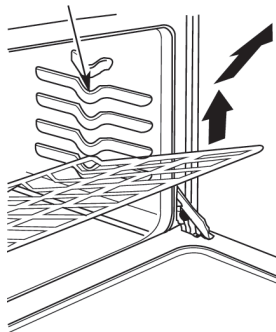

## Before you begin...

To avoid possible burns, place the shelves in the desired position before you turn the oven on.

The shelves have stop-locks, so that when placed correctly on the shelf supports (A through E), they will stop before coming completely out, and will not tilt.

When placing and removing cookware, pull the shelf out to the bump on the shelf support.

**To remove a shelf,** pull it toward you, tilt the front end up and pull it out.

**To replace,** place the end of the shelf (stop-locks) on the support, tilt up the front and push the shelf in.

**NOTE:** The shelf is not designed to slide out at the special low shelf (R) position.

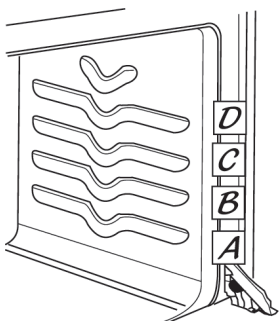

The oven has 4 shelf positions.

## Oven shelf positions

The oven has four shelf supports—A (bottom), B, C and D (top).

Safety Instructions

Operating Instructions

Care and Cleaning

Installation Instructions

Troubleshooting Tips

Consumer Support

# Using the oven.

Safety Instructions



Operating Instructions

## How to Set the Oven for Baking or Roasting

- 1 Touch the **BAKE** pad.
- 2 Touch the **+ or -** pad to set the desired temperature
- 3 Touch the **START** pad.
- 4 Check food for doneness at minimum time on recipe. Cook longer if necessary.
- 5 Touch the **CLEAR/OFF** pad when cooking is complete.

**NOTE:** A cooling fan may automatically turn on and off to cool internal parts. This is normal, and the fan may continue to run even after the oven is turned off.

Care and Cleaning

## Preheating and Pan Placement

Preheat the oven if the recipe calls for it. To preheat, set the oven at the correct temperature. Preheating is necessary for good results when baking cakes, cookies, pastry and breads.

For ovens without a preheat indicator light or tone, preheat 10 minutes.

Baking results will be better baking pans are centered in the oven as much as possible. Pan should not touch each other or the walls of the oven. If you need to use two shelves, stagger the pans so one is not directly above the other, and leave approximately 1 1/2" between pans, from the front, back and slides of the wall.

Installation Instructions

## Aluminum Foil

Do not use aluminum foil on the bottom of the oven.

Never entirely cover a shelf with aluminum foil. This will disturb the heat circulation and result in poor baking.

A smaller sheet of foil may be used to catch a spillover by placing it on a lower shelf several inches below the food.

Troubleshooting Tips

## How to Set the Oven for Broiling

**NOTE:** Close the door before start any broiling function.

On models without an oven temperature knob:

- 1 Place the meat or fish on a broiler grid in a broiler pan designed for broiling.
- 2 Touch the **BROIL HI/LO** pad once for **HI Broil**. To change to **LO Broil**, touch the **BROIL HI/LO** pad again.
- 3 Touch the **START** pad.
- 4 **CLEAR/OFF** pad.

If your oven is connected to 208 volts, rare steaks may be broiled by preheating the broiler and positioning the oven shelf one position higher.

On models with an oven temperature knob:

- 1 Place the meat or fish on a broiler grid in a broiler pan.
- 2 Follow suggested rack positions in the **Broiling Guide**.
- 3 Close the oven door.
- 4 Turn the Oven Temperature Knob to **Broil**.
- 5 When broiling is finished, turn the Oven temperature Knob to **OFF**.

Consumer Support

# Using the clock, timer and convenience outlet. *(on some models)*

Not all features are on all models.

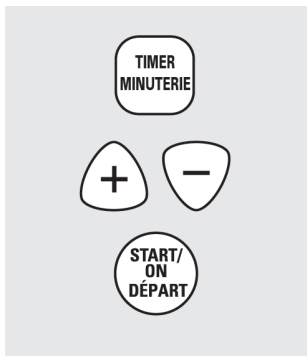

Make sure the clock is set to the correct time of day.

## To Set the Clock

The clock must be set to the correct time of day for the automatic oven timing functions to work properly. The time of day cannot be changed during a timed baking or self-cleaning cycle.

- 1 Touch **TIMER** pad and hold for 3 seconds
- 2 Touch the + or – pads.

If the + or – pads are not touched within one minute after you touch the **TIMER** pad, the display reverts to the original setting. If this happens, touch the **TIMER** pad and reenter the time of day.

- 3 Touch the **START/ON** pad until the time of day shows in the display. This enters the time and starts the clock.

*To check the time of day when the display is showing other information, simply touch the **TIMER** pad. The time of day shows until another pad is touched.*

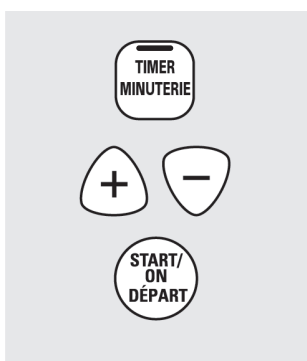

The timer is a minute timer only. The **OFF** pad does not affect the timer.

## To Set the Timer

The timer does not control oven operations. The maximum setting on the timer is 9 hours and 59 minutes.

- 1 Touch the **TIMER** pad.
- 2 Touch the + or – pads until the amount of time you want shows in the display. The maximum time that can be entered in minutes is 59. Times more than 59 minutes should be changed to hours and minutes.

If you make a mistake, touch the **TIMER** pad and begin again.

- 3 Touch the **START/ON** pad. The time will start counting down, although the display does not change until one minute has passed.
- 4 When the timer reaches :00, the control will beep 3 times followed by one beep every 6 seconds until the **TIMER** pad is touched.

Safety Instructions

Operating Instructions

Care and Cleaning

Installation Instructions

Troubleshooting Tips

Consumer Support

Safety Instructions
Operating Instructions
Care and Cleaning
Installation Instructions
Troubleshooting Tips
Consumer Support

## Using the clock, timer and convenience outlet. *(on some models)*

Not all features are on all models.

### To Reset the Timer

If the display is still showing the time remaining, you may change it by touching the **TIMER** pad, then touch the + or – pads until the time you want appears in the display.

If the remaining time is not in the display (clock, delay start or cooking timer are in the display), recall the remaining timer by touching the **TIMER** pad and then touching the + or – pads to enter the new time you want.

### To Cancel the Timer

Touch the **TIMER** pad twice.



OR



### End of Cycle Tones *(on some models)*

Clear the tones by pressing the pad of the function you are using.

### Power Outage

If a flashing time is in the display, you have experienced a power failure. Reset the clock.

To reset the clock, touch the **TIMER** pad twice. Enter the correct time of day by touching the + or – pads. Touch the **START/ON** pad.

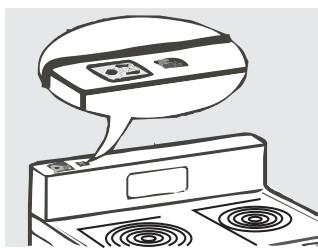

### Convenience Outlet *(on some models)*

The 120V convenience outlet located on the top of the backguard may be used to plug in small electrical appliances.

When using the outlet, be sure that the electrical cord does not rest on or near a surface unit. If the surface unit is turned on, the cord will be damaged.

To reset the circuit breaker, press the switch located near the outlet on top of the backguard.

# Using the timed baking and roasting features, (on some models)

**NOTE:** Foods that spoil easily—such as milk, eggs, fish, stuffings, poultry and pork—should not be allowed to sit for more than 1 hour before or after cooking. Room temperature promotes the growth of harmful bacteria. Be sure that the oven light is off because heat from the bulb will speed harmful bacteria growth.

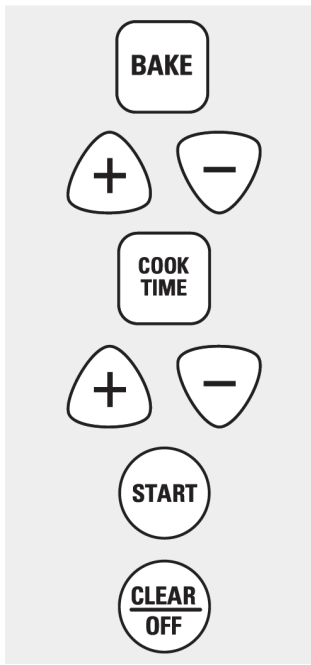

## How to Set an Immediate Start and Automatic Stop

The oven will turn on immediately and cook for a selected length of time. At the end of the cooking time the oven will turn off automatically.

Make sure the clock shows the correct time of day.

- 1 Touch the **BAKE** pad.
- 2 Using the + or – pad, enter the desired temperature.
- 3 Touch the **COOK TIME** pad.

**NOTE:** If your recipe requires preheating, you may need to add additional time to the length of the cooking time.

- 4 Using the + or – pad, enter the desired baking time.

The oven temperature and the cooking time that you entered will be displayed.

- 5 Touch the **START** pad.

The display shows the oven temperature that you set and the cooking time countdown. The display starts changing once the temperature reaches 100° F.

The oven will continue to cook for the programmed amount of time, then shut off automatically.

Touch the **CLEAR/OFF** pad to clear the display.

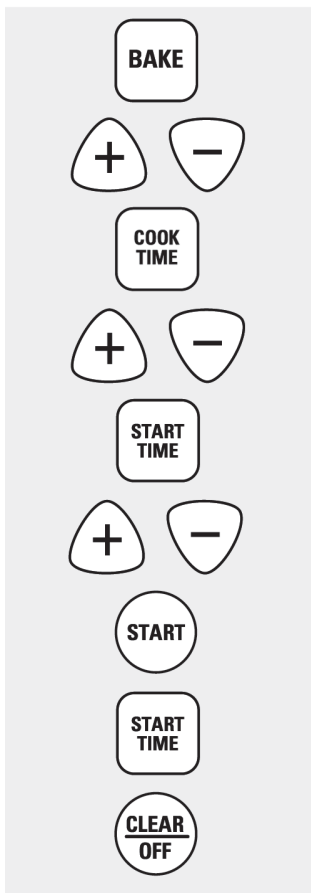

## How to Set a Delayed Start and Automatic Stop

You can set the oven control to delay-start the oven, cook for a specific length of time and then turn off automatically.

Make sure the clock shows the correct time of day.

- 1 Touch the **BAKE** pad.
- 2 Using the + or – pad, enter the desired temperature.
- 3 Touch the **COOK TIME** pad.

**NOTE:** If your recipe requires preheating, you may need to add additional time to the length of the cooking time.

- 4 Using the + or – pad, enter the desired baking time.
- 5 Touch the **START TIME** pad.
- 6 Using the + or – pad, enter the time of day you want the oven to turn on and start cooking.

- 7 Touch the **START** pad.

**NOTE:** An attention tone will sound if you are using timed baking and do not touch the **START** pad after entering the baking temperature.

If you would like to check the times you have set touch the **START TIME** pad to check the start time you have set or touch the **COOK TIME** pad to check the length of cooking time you have set.

When the oven turns on at the time of day you have set, the display will show the changing temperature (starting at 100°F) and the cooking time countdown.

At the end of timed baking, the oven will turn off. The end of cycle tone will sound.

Touch the **CLEAR/OFF** pad to clear the display.

# Special features of your oven control.

Your new touch pad control has additional features that you may choose to use. The following are the features and how you may activate them.

The special feature modes can only be activated while the display is showing the time of day. They remain in the control's memory until the steps are repeated.

When the display shows your choice, touch the **START** pad. The special features will remain in memory after a power failure, except for the Sabbath feature, which will have to be reset.

Safety Instructions

Operating Instructions

Care and Cleaning

Installation Instructions

Troubleshooting Tips

Consumer Support

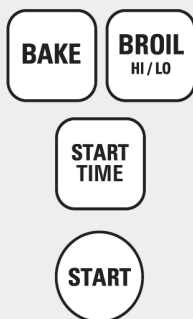

## 12 Hour Shut-Off

With this feature should you forget and leave the oven on, the control will automatically turn off the oven after 12 hours during baking functions or after 3 hours during a broil function.

If you wish to turn off this feature, follow the steps below.

- 1 Touch the **BAKE** and **BROIL HI/LO** pads at the same time for 3 seconds until the display shows **SF**.
- 2 Touch the **START TIME** pad. The display will show **12 shdn** (12 hour shut-off). Touch the **START TIME** pad again and the display will show **no shdn** (no shut-off).
- 3 Touch the **START** pad to activate the no shut-off and leave the control set in this special features mode.

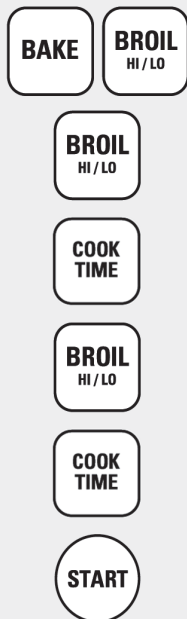

## Fahrenheit or Celsius Temperature Selection

Your oven control is set to use the Fahrenheit temperature selections but you may change this to use the Celsius selections.

- 1 Touch the **BAKE** and **BROIL HI/LO** pads at the same time for 3 seconds until the display shows **SF**.
- 2 Touch the **BROIL HI/LO** and **COOK TIME** pads at the same time for 2 seconds. The display will show **F** (Fahrenheit).
- 3 Touch the **BROIL HI/LO** and **COOK TIME** pads again the same time for 2 seconds. The display will show **C** (Celsius).
- 4 Touch the **START** pad.



## Control Lockout

Your control will allow you to lock down the touch pads so they cannot be activated when touched.

- 1 Touch the **BAKE** and **BROIL HI/LO** pad at the same time for 3 seconds until the display shows **SF**.
- 2 Touch the **SELF CLEAN** pad. The display will show **LOC OFF**.  
Touch the **SELF CLEAN** pad again. The display will show **LOC ON**.
- 3 Touch the **START** pad to activate the control lockout feature and leave the control set in this special features mode.

When this feature is on and the touch pads are touched the control will beep and the display will show **LOC**.

**NOTE:** The control lockout mode will not affect the **TIMER/CLOCK** and **OVEN LIGHT ON/OFF** touch pads.



# Special features of your oven control.

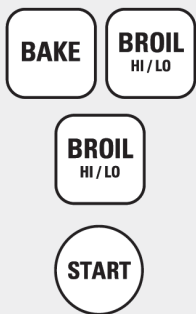

## Tones at the End of a Timed Cycle

At the end of a timed cycle, 3 short beeps will sound followed by one beep every 6 seconds until the CLEAR/OFF pad is touched. This continuous 6 second beep may be canceled.

To cancel the 6 second beep:

- 1 Touch the **BAKE** and **BROIL HI/LO** pads at the same time for 3 seconds until the display shows **SF**.

- 2 Touch the **BROIL HI/LO** pad. The display shows **CON BEEP** (continuous beep). Touch the **BROIL HI/LO** pad again. The display shows **BEEP**. (This cancels the one beep every 6 seconds.)

- 3 Touch the **START** pad.

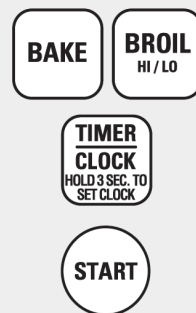

## 12 Hour, 24 Hour or Clock Black-Out

Your control is set to use a 12 hour clock.

If you would prefer to have a 24 hour military time clock or black-out the clock display, follow the steps below.

- 1 Touch the **BAKE** and **BROIL HI/LO** pads at the same time for 3 seconds until the display shows **SF**.

- 2 Touch the **TIMER/CLOCK** pad once. The display will show **12 hr**. If this is the choice you want touch the **START** pad.

Touch the **TIMER/CLOCK** pad again to change to the 24 hour military time clock. The display will show **24 hr**. If this is the choice you want touch the **START** pad.

Touch the **TIMER/CLOCK** pad again to black-out the clock display. The display will show **OFF**. If this is the choice you want touch the **START** pad.

**NOTE:** If the clock is in the black-out mode you will not be able to use the Delay Start function.

# Special features of your oven control.

Safety Instructions

Operating Instructions

Care and Cleaning

Installation Instructions

Troubleshooting Tips

Consumer Support



## Cook and Hold

Your new control has a cook and hold feature that keeps cooked foods warm for up to 3 hours after Timed Baking or Roasting is finished.

**NOTE:** This feature can only be programmed to work with Timed Baking or Roasting (See the Using the timed baking and roasting features section). After Timed Baking or Roasting has automatically stopped, the programmed Cook and Hold will automatically start.

To activate this feature for use after Timed Baking or Roasting, follow the steps below.

1 Touch the **BAKE** and **BROIL HI/LO** pads at the same time for 3 seconds until the display shows **SF**.

2 Touch the **COOK TIME** pad. The display will show **Hid OFF**.

Touch the **COOK TIME** pad again to activate the feature. The display will show **Hid ON**.

3 Touch the **START** pad to activate the cook and hold feature and leave the control set in this special features mode.

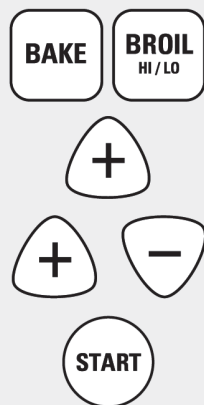

## Changing the Speed of the + or - Pads

As you use the + or - pads when setting a time or temperature, you may notice the display changes slowly. This special feature allows you to change the speed. To set the speed you prefer follow the steps below.

1 Touch the **BAKE** and **BROIL HI/LO** pads at the same time for 3 seconds until the display shows **SF**.

2 Touch the **+** pad. The display will show you a set speed between 1 and 5

3 Touch the **+** pad to increase the speed up to the number 5

Touch the **-** pad to decrease the speed down to the number 1.

4 Touch **START** to activate the setting and leave the control set in this special mode.

# Using the Sabbath Feature.

(Designed for use on the Jewish Sabbath and Holidays) (on some models)

The Sabbath feature can be used for baking/roasting only. It cannot be used for broiling, self-cleaning, or Delay Start cooking.

**NOTE:** The oven light comes on automatically (on some models) when the door is opened and goes off when the door is closed. The bulb may be removed. See the Oven Light Bulb section. On models with a light switch on the control panel, the oven light may be turned on and left on.

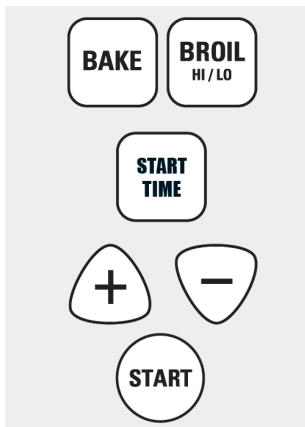

When the display shows «  $\supset$  » the oven is set in Sabbath. When the display shows  $\supset$   $\subset$  the oven is baking/roasting.

## How to Set Sabbath Feature for Regular Baking /Roasting

**NOTE:** To understand how the oven control works, practice using regular baking (non – Sabbath) before entering Sabbath mode.

Make sure the clock shows the correct time of day.

- 1 Touch and hold **both** the **BAKE** and **BROIL HI/LO** pads, **at the same time**, until the display shows **SF**.

**NOTE:** If bake or broil appears in the display, the **BAKE** and **BROIL HI/LO** pads were not touched at the same time. Touch the **CLEAR/OFF** pad and begin again.

- 2 Tap the **START TIME** pad until **Sabbath** appears in this display.
- 3 Touch the **START** pad and  $\supset$  will appear in the display.
- 4 Touch the **BAKE** pad. No signal will be given.

- 5 The preset starting temperature will automatically be set to 350°. Tap the + or – pad to increase or decrease the temperature in 5° increments. The temperature can be set between 170° and 550°. No signal or temperature will be given.

- 6 Touch the **START** pad.

- 7 After a random delay period of approximately 30 seconds to 1 minute,  $\supset$   $\subset$  will appear in the display indicating that the oven is baking/roasting. If  $\supset$   $\subset$  does not appear in the display, start again at step 4.

To adjust the oven temperature, touch the **BAKE** pad and tap the + or – pad to increase or decrease the temperature in 5° increments. Touch the **START** pad.

**NOTE:** The **CLEAR/OFF** and **COOK TIME** pads are active during the Sabbath feature.

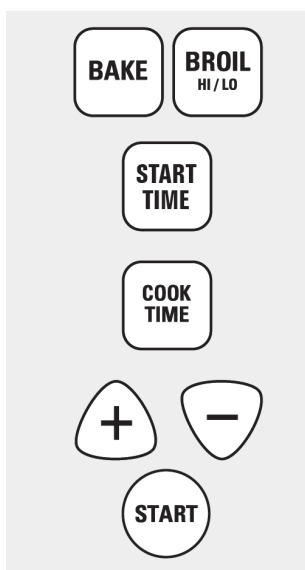

When the display shows  $\supset$  the oven is set in Sabbath. When the display shows  $\supset$   $\subset$ , the oven is baking/roasting.

## How to Set Sabbath Feature for Timed Baking/Roasting—Immediate Start and Automatic Stop.

**NOTE:** To understand how the oven control works, practice using regular (non – Sabbath) immediate Start and Automatic Stop before entering the Sabbath mode.

Make sure clock shows the correct time of day.

- 1 Touch and hold **both** the **BAKE** and **BROIL HI/LO** pads, **at the same time**, until the display shows **SF**.

**NOTE:** If bake or broil appears in the display, the **BAKE** and **BROIL HI/LO** pads were not touched at the same time. Touch the **CLEAR/OFF** pad and begin again.

- 2 Tap the **START TIME** pad until **Sabbath** appears in the display.
- 3 Touch the **START** pad and  $\supset$  will appear in the display.
- 4 Touch the **COOK TIME** pad.
- 5 Touch the + or – pad to set the desired length of cooking time between 1 minute and 9 hours and 59 minutes. The cooking time that you entered will be displayed.
- 6 Touch the **START** pad.

- 7 Touch the **BAKE PAD**. No signal will be given.

- 8 The preset starting temperature will automatically be set to 350°. Tap the + or – pad to increase or decrease the temperature in 5° increments. The temperature can be set between 170° and 550°. No signal or temperature will be given.

- 9 Touch the **START** pad.

- 10 After a random delay period of approximately 30 seconds to 1 minute,  $\supset$   $\subset$  will appear in the display indicating that the oven is baking/roasting. If  $\supset$   $\subset$  does not appear in the display, start again at step 7.

To adjust the oven temperature, touch the **BAKE** pad and tap the + or – pad to increase or decrease the temperature in 5° increments. Touch the **START** pad.

When cooking is finished, the display will change from  $\supset$   $\subset$  to  $\supset$  and **0:00** will appear, indicating that the oven has turned **OFF** but is still set in Sabbath. Remove the cooked food.

# Using the Sabbath Feature.

(Designed for use on the Jewish Sabbath and Holidays) (on some models)

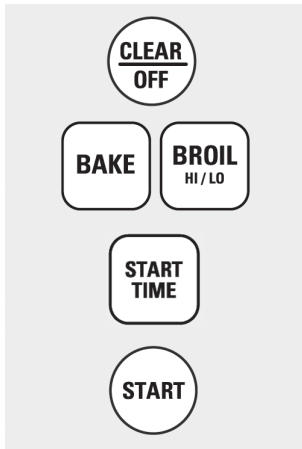

## How to Exit the Sabbath Feature

- 1 Touch the **CLEAR/OFF** pad.
- 2 If the oven is cooking, wait for a random delay period of approximately 30 seconds to 1 minute, until only  $\square$  is in the display.
- 3 Touch and hold **both** the **BAKE** and **BROIL HI/LO** pads, **at the same time**, until the display shows **SF**.
- 4 Tap the **START TIME** pad until **12 shdn** or **no shdn** appears in the display. **12 shdn** indicates that the oven will automatically turn off after 12 hour. **no shdn** indicates that the oven will not automatically turn off.

- 5 Touch the **START** pad.

**NOTE:** If a power outage occurred while the oven was in Sabbath mode, the oven will automatically turn off and the oven control must be reset.

## Temperature Conversions

° Fahrenheit	140	150	170	200	250	275	300	325	350	375	400	425	450	475	500	525	550
° Celsius	60	65	75	95	120	135	150	160	175	190	205	220	230	245	260	275	290

## Power Outage

If a flashing time is in the display, you have experienced a power failure. Reset the clock.

To reset the clock, touch the **TIMER** pad. Enter the correct time of day by touching the + or – pads. Touch the **STAT/ON** pad.

# Adjust the oven thermostat – Easy to do yourself!

You may find that your new oven cooks differently than the one it replaced. Use your new oven for a few weeks to become more familiar with it. If you still think your new oven is too hot or too cold, you can adjust the thermostat yourself.

Do not use thermometers, such as those found in grocery stores, to check the temperature setting of your oven. These thermometers may vary 20-40°F.

**NOTE:** This adjustment will not affect the broiling or the self-cleaning temperatures (on some models). The adjustment will be retained in memory after a power failure.

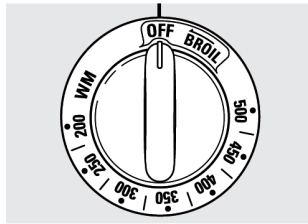

Front of OVEN TEMP knob  
(knob appearance may vary)

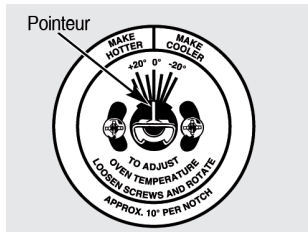

Back of OVEN TEMP knob

## To Adjust the Thermostat with this Type of Knob

- 1 Pull the Oven Temp knob off the shaft, look at the back of the knob and note the current setting **before** making any adjustments.
- 2 Loosen both screws on the back of the knob.
- 3 To **increase** the oven temperature, move the pointer toward the words **"MAKE HOTTER."**

To decrease the oven temperature, turn the pointer toward the words **"MAKE COOLER."**

Each notch changes the temperature by 10°F.

4 Tighten the screws.

5 Replace the knob, matching the flat area of the knob to the shaft.

**Note:**  
Except Model JCAS445

## To Adjust the Thermostat on Other Models

- 1 Touch the **BAKE** and **BROIL** pads at the same time for 2 seconds until the display shows **SF**.
- 2 Touch the **BAKE** pad. A two digit number shows in the display.
- 3 The oven temperature can be adjusted up to (+) 35° F hotter or (-) 35° F cooler. Touch the + pad to increase the temperature in 1 degree increments. Touch the - pad to decrease the temperature in 1 degree increments.

4 When you have made the adjustment, touch the **START/ON** pad to go back to the time of day display. Use your oven as you would normally.

**NOTE:** This adjustment will not affect the broiling or self-cleaning temperatures. It will be retained in memory after a power failure.

## The type of margarine will affect baking performance!

**Most recipes for baking have been developed using high fat products such as butter or margarine (80% fat). If you decrease the fat, the recipe may not give the same results as with a high fat product.**

Recipe failure can result if cakes, pies pastries, cookies or candies are made with low fat spreads. The lower the fat content of a spread product, the more noticeable these differences become.

Federal standards require products labeled "margarine" to contain at least 80% fat by weight. Low-fat spreads, on the other hand, contain less fat and more water. The high moisture content of these spreads affects the texture and flavor of baked goods. For best results with your old favorite recipes, use margarine, butter or stick spreads containing at least 70% vegetable oil.

Safety Instructions

Operating Instructions

Care and Cleaning

Installation Instructions

Troubleshooting Tips

Consumer Support

## Using the self-cleaning oven. (on some models)

The oven door must be closed and all controls must be set correctly for the cycle to work properly.

Safety Instructions

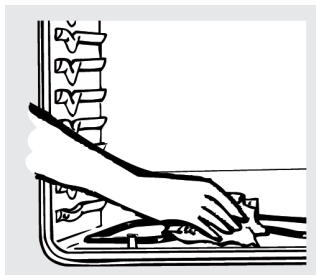

Wipe up heavy soil on the oven bottom. (appearance may vary)

Operating Instructions

### Before a Clean Cycle

The oven must be cool in order to set the self-clean cycle.

We recommend venting your kitchen with an open window or using a ventilation fan or hood during the first self-clean cycle.

Remove broiler pan, broiler grid, all cookware and any aluminum foil from the oven.

The shiny, silver, colored oven shelves (on some models) can be self-cleaned, but they will darken, lose their luster and become hard to slide.

Do not use abrasives or oven cleaners. Clean the top, sides and outside of the oven door with soap and water.

Make sure the oven light bulb cover (on some models) is in place and the oven light is off.

**IMPORTANT:** The health of some birds is extremely sensitive to the fumes given off during the self-cleaning cycle of any oven. Move birds to another well ventilated room.

Care and Cleaning

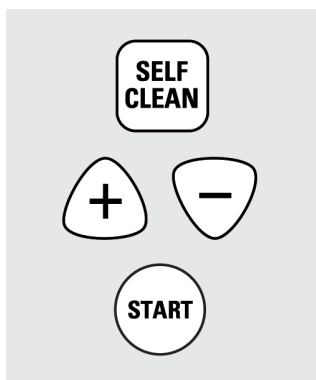

### How to Set the Oven for Cleaning

- 1 Touch the **SELF CLEAN** pad.
- 2 Using the + or – pad, enter the desired clean time, if a time other than 4 hours is needed.

Clean cycle time is normally 4 hours. You can change the clean time to any time between 3 hours and 5 hours, depending on how dirty your oven is.

- 3 Touch the **START** pad.

■ The words **LOCK DOOR** will flash and the oven control will signal if you set the clean cycle and forget to close the oven door.

■ To stop a clean cycle, touch the **CLEAR/OFF** pad. When the **LOCKED DOOR** light goes off indicating the oven has cooled below the locking temperature, open the door.

Installation Instructions

The door locks automatically. The display will show the clean time remaining. It will not be possible to open the oven door until the temperature drops below the lock temperature and the **LOCKED DOOR** light goes off.

When the **LOCKED DOOR** light is off, open the door.

Troubleshooting Tips

Consumer Support

# Using the self-cleaning oven. (on some models)

The oven door must be closed and all controls must be set correctly for the cycle to work properly.

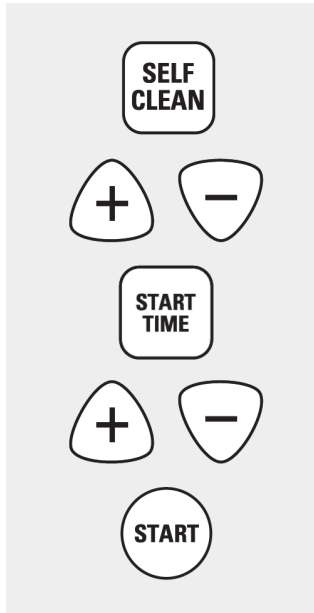

## How to Delay the Start of Cleaning.

- 1 Touch the **SELF CLEAN** pad.
- 2 Using the + or – pad, enter the desired clean time.
- 3 Touch the **START TIME** pad.
- 4 Using the + or – pad, enter the time of day you want the clean cycle to start.
- 5 Touch the **START** pad.

The door locks automatically. The display will show the start time. It will not be possible to open the oven door until the temperature drops below the lock temperature and the **LOCKED DOOR** light goes off.

When the **LOCKED DOOR** light is off, open the door.

## After a Clean Cycle

You may notice some white ash in the oven. Wipe it up with a damp cloth after the oven cools.

If white spots remain, remove them with a *soap-filled scrubbing pad and rinse thoroughly* with a vinegar and water mixture.

These deposits are usually a salt residue that cannot be removed by the clean cycle.

If the oven is not clean after one clean cycle, repeat the cycle.

- You cannot set the oven for cooking until the oven is cool enough for the door to unlock.
- If the shelves become hard to slide, wipe the shelf supports with cooking oil.

# Care and cleaning of the range.

Be sure electrical power is off and all surfaces are cool before cleaning any part of the range.



If your range is removed for cleaning, servicing or any reason, be sure the anti-tip device is re-engaged properly when the

range is replaced. Failure to take this precaution could result in tipping of the range and cause injury.

## Oven Interior (non-self clean models)

With proper care, the porcelain enamel finish on the inside of the oven-top, bottom, sides, back and inside of the door will stay new-looking for years.

Let the range cool before cleaning. We recommend that you wear rubber gloves when cleaning the range.

Soap and water will normally do the job. Heavy spattering or spillovers may require cleaning with a mild abrasive cleaner. Soap-filled scouring pads may also be used.



Do not allow food spills with a high sugar or acid content (such as milk, tomatoes, sauerkraut, fruit juices or pie filling) to remain on the surface. They may cause a dull spot even after cleaning.

Household ammonia may make the cleaning job easier. Place ½ cup in a shallow glass or pottery container in a cold

oven overnight. The ammonia fumes will help loosen the burned-on grease and food.

If necessary, you may use an oven cleaner. Follow the package directions.

Do not spray oven cleaner on the electrical controls and switches because it could cause a short circuit and result in sparking or fire.

Do not allow a film from the cleaner to build up on the temperature sensor-it could cause the oven to heat improperly. (The sensor is located at the top of the oven.) Carefully wipe the sensor clean after each oven cleaning, being careful not to move the sensor as a change in its position could affect how the oven bakes.

Do not spray any oven cleaner on the oven door, handles or any exterior surface of the oven, cabinets or painted surfaces. The cleaner can damage these surfaces.

## To clean the inside of the door:

- Do not allow excess water to run into any holes or slots in the door.
- Soap and water will normally do the job. Heavy spattering or spillovers may require cleaning with a mild abrasive cleaner. Soap-filled, steel-wool pads may also be used.

Do not allow food spills with a high sugar or acid content (such as milk, tomatoes, sauerkraut, fruit juices or pie filling) to remain on the surface. They may cause a dull spot even after cleaning.

## To clean the outside of the door:

- Use soap and water to thoroughly clean the top, sides and front of the oven door. Rinse well. You may also use a glass cleaner to clean the glass on the outside of the door. Do not let water drip into the vent openings.
- Spillage of marinades, fruit juices, tomato sauces and basting materials containing acids may cause discoloration and should be wiped up immediately. When surface is cool, clean and rinse.
- Do not use oven cleaners, cleaning powders or harsh abrasives on the outside of the door.

## To clean outside of the gasket:

The gasket is designed with a gap at the bottom to allow for proper air circulation. Because the area inside the gasket is cleaned during the self-clean cycle, you do not need to clean this by hand on self-clean models.

The area outside the gasket and the front frame can be cleaned with a soap-filled steel-wool pad, hot water and detergent. Rinse well with a vinegar and water solution.

Do not rub or clean the door gasket-it has an extremely low resistance to abrasion. If you notice the gasket becoming worn, frayed or damaged in any way, or if it has become displace on the door, you should have it replaced.

## Porcelain Enamel Cooktop (on some models)

The porcelain enamel finish is sturdy but breakable if misused. This finish is acid-resistant. However, any acidic foods spilled (such as fruit juices, tomato or vinegar) should not be permitted to remain on the finish.

If acid spill on the cooktop while it is hot, use a dry paper towel or cloth to wipe it up right away. When the surface has cooled, wash with soap and water. Rinse well.

For other spills such as fat splatterings, wash with soap and water or cleansing powders after the surface has cooled. Rinse well. Polish with a dry cloth.

Safety Instructions

Operating Instructions

Care and Cleaning

Installation Instructions

Troubleshooting Tips

Consumer Support



# Care and cleaning of the range.

## Lift-up Cooktop

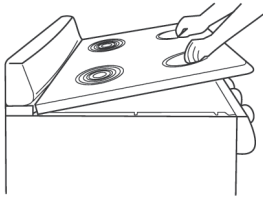

Clean the area under the cooktop often. Built-up soil, especially grease, may catch on fire.

To make cleaning easier, the cooktop may be lifted up and propped open.

Be sure all surface units are turned off before raising the cooktop.

Remove the front surface and drip pans. See the Surface Units and Drip Pans section. Grasp the two front surface unit wells and lift the cooktop up and prop it open with the prop rod provided.

After cleaning underneath the cooktop with hot, soapy water and a clean cloth, hold the cooktop up, return the prop rod to its storage position and lower the cooktop until it snaps into position. Be careful not to pinch your fingers. Replace the two front drip pans and surface units. See the Surface Units and Drip Pans section.

## Lift-Off Oven Door

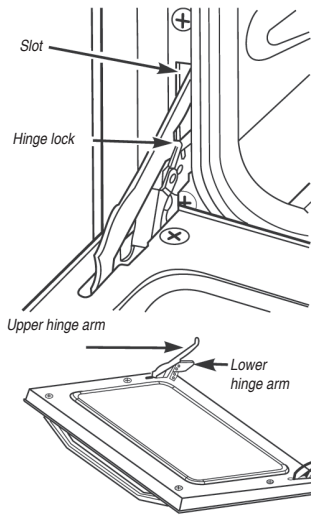

The oven door is removable, but it is heavy. You may need help removing and replacing the door.

### To remove the door:

- 1 Open the door to the full open position.
- 2 Pull the hinge locks up over the hinge hooks on both sides.
- 3 Grasp the door firmly on each side, lift slightly and pull it straight out and away from the oven.

### To replace the door:

- 1 Firmly grasp both sides of the door at the top.
- 2 Insert and seat the upper and lower hinge arms into the oven slots.
- 3 Push the hinge locks down from the hinge hooks.
- 4 Close the oven door and make sure it is working properly. If it is not working properly, remove and replace it following the above steps.

**DO NOT ATTEMPT TO CLOSE THE DOOR UNTIL THIS STEP IS COMPLETE THE HINGE OR DOOR COULD BE DAMAGED.**

## Oven Heating Elements

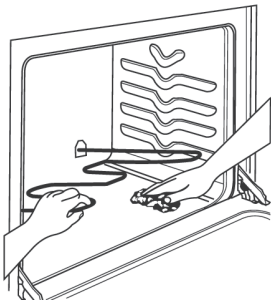

Do not clean the bake element or the broil element. Any soil will burn off when the elements are heated.

The bake elements can be lifted gently to clean the oven floor. Do not attempt to clean any oven surface when any burner element is on. Always wear protective hand-wear when cleaning interior oven surfaces or surfaces near heating

elements. If spillovers, residue or ash accumulate around the bake element, gently wipe around the element with warm water.

## Broiler Pan and Grid

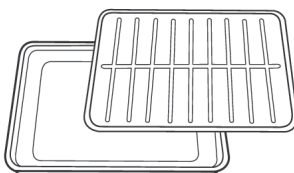

Both the broiler pan and grid can also be cleaned in the dishwasher.

After broiling, remove the broiler pan from the oven. Remove the grid from the pan. Carefully pour out grease from the pan into a proper container. Wash and rinse the broiler pan and grid in hot water with a soap-filled or plastic scouring pad.

If food has burned on, sprinkle the grid with detergent while hot and cover with wet paper towels or a dishcloth. Soaking the pan will remove burned on foods.

*Do not store a soiled broiler pan and grid anywhere in the range.*

# Care and cleaning of the range.

Safety Instructions

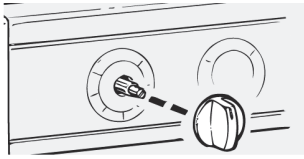

Pull the knob straight off the stem.

## Control Panel and Knobs

It's a good idea to wipe the control panel after each use of the oven. Use a damp cloth to clean or rinse. For cleaning, use mild soap and water or a 50/50 solution of vinegar and water. For rinsing, use clean water. Polish dry with a soft cloth.

Do not use abrasive cleaners, strong liquid cleaners, plastic scouring pads or oven cleaners on the control panel—they will damage the finish.

The control knobs may be removed for easier cleaning.

Make sure the knobs are in the **OFF** positions and pull them straight off the stems for cleaning

The knobs can be cleaned in a dishwasher or they may also be washed with soap and water. Make sure the insides of the knobs are dry before replacing.

Replace the knobs in the **OFF** position to ensure proper placement.

Operating Instructions

Care and Cleaning

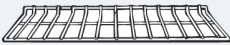

## Oven Shelves

Clean the oven shelves with an abrasive cleanser or scouring pad. After cleaning, rinse the shelves with clean water and dry with a clean cloth.

**NOTE:** Take the shelves out of the oven before you begin the self-clean cycle or they may discolor.

To make the shelves slide more easily, apply a small amount of vegetable oil or cooking oil to a paper towel and wipe the edges of the oven shelves with the paper towel.

Installation Instructions

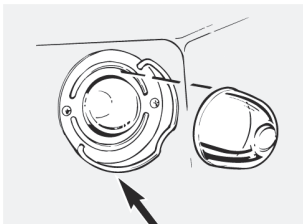

Wire cover holder

## Oven Light Replacement (on some models)

**CAUTION:** Before replacing your oven light bulb, turn the oven light off and disconnect the electrical power to the range at the main fuse or circuit breaker panel.

Be sure to let the light cover and bulb cool completely.

### To remove the cover:

- 1 Hold a hand under the cover so it doesn't fall when released. With fingers of the same hand, firmly push back the wire cover holder. Lift off the cover.

*Do not remove any screws to remove the cover*

- 2 Replace bulb with a 40-watt household appliance bulb.

### To replace the cover:

- 1 Place it into groove of the light receptacle. Pull wire forward to the center of the cover until it snaps into place.
- 2 Connect electrical power to the range.

Troubleshooting Tips

Consumer Support



Clean under the range

## Storage Drawer Removal (on some models)

### To remove the storage drawer:

- 1 Pull the drawer out all the way.
- 2 Tilt up the front and remove it.

### To replace the storage drawer:

- 1 Insert glides at the back of the drawer beyond the stop on range glides.
- 2 Lift the drawer if necessary to insert easily.
- 3 Let the front of the drawer down, then push in to close

# Care and cleaning of the range.

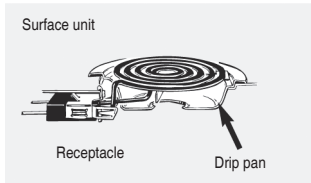

## Surface Units (on some models)

Be sure all the controls are turned to OFF and the surface units are cool before attempting to remove them.

To clean the surface units, turn the control to the highest setting for a minute. The coils will burn off any soil.

### To remove a surface unit:

To remove the drip pans for cleaning, the surface units must be removed first.

Lift the surface unit about 1 inch above the drip pan and pull it out.

*Do not lift the surface unit more than 1". If you do, it may not lie flat on the drip pan when you plug it back in.*

Repeated lifting of the surface unit more than 1 inch above the drip pan can permanently damage the receptacle.

### To replace a surface unit:

Replace the drip pan into the recess in the cooktop. Make sure the opening in the pan lines up with the receptacle.

Insert the terminals of the surface unit through the opening in the drip pan and into the receptacle.

Guide the surface unit into place so it rests evenly.



*Do not immerse the surface units in liquids of any kind.*

*Do not clean the surface units in a dishwasher.*

*Do not bend the surface unit plug terminals.*

*Do not attempt to clean, adjust or in any way repair the plug-in receptacle.*

## Drip Pans (if included)

Remove the surface units. Then lift out the drip pans.

Place them in a covered container. Add  $\frac{1}{4}$  cup ammonia and let soak several hours or overnight. Wash, rinse well and dry.

The drip pans may also be cleaned in the dishwasher.

Clean the area under the drip pans often. Built-up soil, especially grease, may catch fire.

*Do not cover the drip pans with foil. Using foil so close to the receptacle could cause shock, fire or damage to the range.*

**NOTE:** Do not clean the drip pans in a self-cleaning oven.

Safety Instructions

Operating Instructions

Care and Cleaning

Installation Instructions

Troubleshooting Tips

Consumer Support

## Care and cleaning of the range.

Safety Instructions



### Oven Vent

On glass cooktop models, the oven is vented through an opening at the rear of the cooktop.

On coil cooktop models, the oven is vented through an opening under the right rear surface unit.

**Never cover the opening with aluminum foil or any other material.**

Operating Instructions

### Painted Surfaces *(on some models)*

Painted surfaces include the sides of the range and the sides of the door trim.

To clean the painted surfaces, use a hot, damp cloth with a mild detergent suitable for these surfaces. Use a clean, hot, damp cloth to remove soap. Dry with a dry, clean cloth.

Do not use steel-wood pads, commercial oven cleaners, cleaning powders or other abrasive cleaners. They will damage the surface.

Care and Cleaning

### Stainless Steel Surfaces *(on some models)*

**Do not use a steel wool pad; it will scratch the surface.**

To clean the stainless steel surface, use warm sudsy water or a stainless steel cleaner or polish. Always wipe the surface in the direction of the grain. Follow the cleaner instructions for cleaning the stainless steel surface.

To inquire about purchasing stainless steel appliance cleaner or polish, or to find the location of a dealer or Camco Parts Store nearest you, please call our toll-free number:

**National Parts Centre 1.800.661.1616**

**[www.GEAppliances.ca](http://www.GEAppliances.ca)**

Installation Instructions

Troubleshooting Tips

Consumer Support

### Glass Window *(on some models)*

To clean the outside glass finish, use a glass cleaner. Rinse and polish with a dry cloth.

# Cleaning the glass cooktop. *(on some models)*



**Clean your cooktop after each spill. Use Ceramic Cooktop Cleaner.**

## Normal Daily Use Cleaning

**ONLY** use Ceramic Cooktop Cleaner on the glass cooktop. Other types of cleaners may not be as effective.

To maintain and protect the surface of your glass cooktop, follow these steps.

- 1 Before using the cooktop for the first time, clean it with Ceramic Cooktop Cleaner. This helps protect the top and makes cleanup easier.
- 2 Daily use of Ceramic Cooktop Cleaner will help keep the cooktop looking new.

- 3 Shake the cleaning cream well. Apply a few drops of Ceramic Cooktop Cleaner directly to the cooktop.
- 4 Use a paper towel for Ceramic Cooktops to clean the entire cooktop surface.
- 5 Use a dry cloth or paper towel to remove all cleaning residue. No need to rinse.

**NOTE:** It is very important that you **DO NOT** heat the cooktop until it has been cleaned thoroughly.



Use a Cleaning Pad for Ceramic Cooktops.

## Burned-On Residue

**WARNING:** DAMAGE to your glass surface may occur if you use scrub pads other than those recommended.

- 1 Allow the cooktop to cool.
- 2 Spread a few drops of Ceramic Cooktop Cleaner on the entire burned residue area.
- 3 Using the included Cleaning Pad for Ceramic Cooktops, rub the residue area, applying pressure as needed.

- 4 If any residue remains, repeat the steps listed above as needed.
- 5 For additional protection, after all residue has been removed, polish the entire surface with Ceramic Cooktop Cleaner and paper towel.

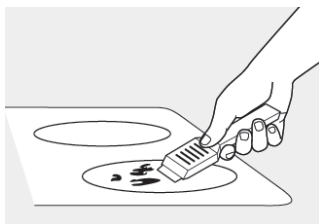

The Ceramic Cooktop Scraper and all recommended supplies are available through our dealers or through a Camco Parts Store.

**Note:** Do not use a dull or nicked blade.

## Heavy Burned-On Residue

- 1 Allow the cooktop to cool.
- 2 Use a single-edge razor blade scraper at approximately a 45° angle against the glass surface and scrape the soil. It will be necessary to apply pressure to the razor scraper in order to remove the residue.

- 3 After scraping with the razor scraper, spread a few drops of Ceramic Cooktop Cleaner on the entire burned residue area. Use the Cleaning Pad to remove any remaining residue.
- 4 For additional protection, after all residue has been removed, polish the entire surface with Ceramic Cooktop Cleaner and a paper towel.

Safety Instructions

Operating Instructions

Care and Cleaning

Installation Instructions

Troubleshooting Tips

Consumer Support

## Cleaning the glass cooktop. (on some models)

### Metal Marks and Scratches

- 1 Be careful not to slide pots and pans across your cooktop. It will leave metal markings on the cooktop surface.

These marks are removable using the Ceramic Cooktop Cleaner with the Cleaning Pad for Ceramic Cooktops.

- 2 If pots with a thin overlay of aluminum or copper are allowed to boil dry the overlay may leave black discoloration on the cooktop.

This should be removed immediately before heating again or the discoloration may be permanent.

**WARNING:** Carefully check the bottom of pans for roughness that would scratch the cooktop.

### Cooktop Seal

To clean the cooktop seal around the edges of the glass, lay a wet cloth on it for a few minutes, then wipe clean with nonabrasive cleaners.



## Glass surface – potential for permanent damage.

**Sugary spillovers (such as jellies, fudge, candy, syrups) or melted plastics can cause pitting of the surface of your cooktop (not covered by the warranty) unless the spill is removed while still hot.**

**Special care should be taken when removing hot substances.**

**Be sure to use a new, sharp razor scraper.**

**Do not use a dull or nicked blade.**

### Damage from Sugary Spills and Melted Plastic

- 1 Turn off all surface units. Remove hot pans.
- 2 Wearing an oven mitt:
  - a. Use a single-edge razor blade scraper to move the spill to a cool area on the cooktop.
  - b. Remove the spill with paper towels.
- 3 Any remaining spillover should be left until the surface of the cooktop has cooled.

- 4 Don't use the surface units again until all of the residue has been completely removed.

**NOTE:** If pitting or indentation in the glass surface has already occurred, the cooktop glass will have to be replaced. In this case, service will be necessary.

### To order Parts

To inquire about purchasing a part or an accessory for your appliance, please call our toll-free number:

**National Parts Center      1-800-661-1616**  
**www.GEAppliances.ca**

**Ceramic Cooktop Cleaner** ..... # WX10X300  
**Ceramic Cooktop Scraper** ..... # WX10X302  
**Kit**..... # WB64X5027  
*(Kit includes cream and cooktop scraper)*  
**Cleaning Pads for**  
**Ceramic Cooktops** ..... # WX10X350

# Installation Instructions

## 24" GE Electric Ranges

Questions? Call 1.800.561.3344 or consults our web page: [www.geappliances.ca](http://www.geappliances.ca)

### BEFORE YOU BEGIN

Read these instructions completely and carefully.

- **IMPORTANT** — Save these instructions for local inspector's use.
- **IMPORTANT** — Observe all governing codes and ordinances.
- **Note to Installer**— Be sure to leave these instructions with the Consumer.
- **Note to Consumer**— Keep these instructions for future reference.
- **Skill level**- Installation of this appliance requires basic mechanical skills.
- **Completion time**— 1 to 3 hours
- Proper installation is the responsibility of the installer.
- Product failure due to improper installation is not covered under the Warranty.

**⚠ WARNING** — This appliance must be properly grounded.

### FOR YOUR SAFETY:

**⚠ WARNING** — Before beginning the installation, switch power off at service panel and lock the service disconnecting means to prevent power from being switched on accidentally. When the service disconnecting means cannot be locked, securely fasten a prominent warning device, such as a tag, to the service panel.

### FOR YOUR SAFETY:

All rough-in and spacing dimensions must be met for safe use of your range. Electricity to the range can be disconnected at the outlet without moving the range if the outlet is in the preferred location (remove lower drawer).

To reduce the risk of burns or fire when reaching over hot surface elements, cabinet storage space above the cooktop should be avoided. If cabinet storage space is to be provided above the cooktop, the risk can be reduced by installing a range hood that sticks out at least 5" beyond the front of the cabinets. Cabinets installed above a cooktop must be no deeper than 13".

Be sure your appliance is properly installed and grounded by a qualified technician.

Make sure the cabinets and wall coverings around the range can withstand the temperatures (up to 200 °F) generated by the range.

### ANTI-TIP DEVICE

**⚠ WARNING** — To reduce the risk of tipping, the appliance must be secured by properly installed Anti-Tip device packed with this appliance.

If the Anti-Tip device supplied with the range does not fit this application, use the universal Anti-Tip device WB2X7909.



### ⚠ WARNING

- All ranges can tip
- Injury to persons could result
- Install Anti-Tip device packed with range
- See Installation Instructions

If you pull the range out and away from the wall for any reason, make sure the Anti-Tip device is engaged when the range is pushed back against the wall.

# Installation Instructions

## PREPARE TO INSTALL THE RANGE

### TOOLS YOU WILL NEED

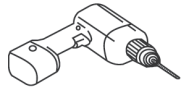

Drill with 1/8" Bit



Safety Glasses



Adjustable Wrench

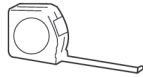

Tape Measure



Pliers



Pencil



1/4" Nut Driver



Level



Phillips Screwdriver



Flat-blade  
Screwdriver

### PARTS INCLUDED



Anti-Tip Bracket Kit

### 1 REMOVE SHIPPING MATERIALS

Remove packaging materials. Failure to remove packaging materials could result in damage to the appliance.

### 2 PREPARE THE OPENING

- Allow 2" spacing from the range to adjacent vertical walls above the cooktop surface. Allow 30" minimum clearance between the surface units and the bottom of unprotected wood or metal top cabinet, and 18" minimum between the countertop and the adjacent cabinet bottom.
- To eliminate the risk of burns or fire when reaching over hot surface elements, cabinet storage space above the cooktop should be avoided. If cabinet storage space is to be provided above cooktop, the risk can be reduced by installing a range hood that protrudes at least 5" beyond the front of the cabinets. Cabinets installed above a cooktop may be no deeper than 13".

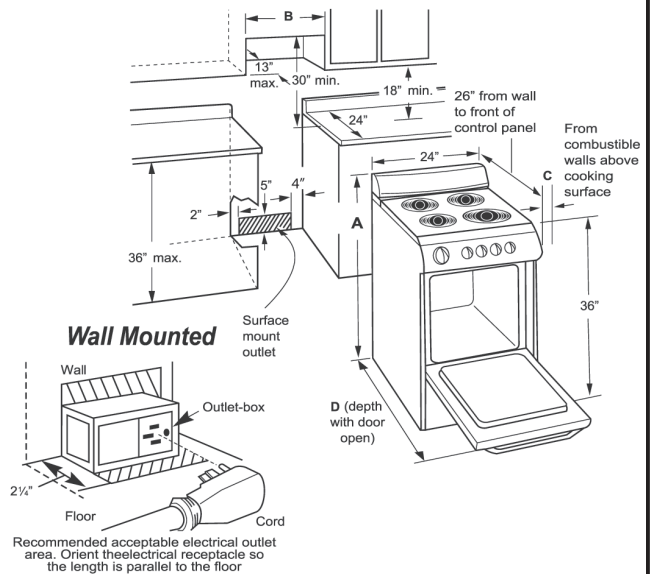

Models	A	B	C (recommended)	D
JCAS745				
JCAP750	47"	24 3/8"	2" (5,08 cm)	41" (104,14 cm)
JCAP760				
JCAP765				
JCAS445	36"	24 3/8"	N/A	41" (104,14 cm)

#### Flooring under the range

Your range, like many other household items, **is heavy and can settle into soft floor coverings** such as cushioned vinyl or carpeting.

When moving the range on this type of flooring, it should be installed on a 1/4" thick sheet of plywood (or similar material) as follows:

When the floor covering ends at the front of the range, the area that the range will rest on should be built up with plywood to the same level or higher than the floor covering. This will allow the range to be moved for cleaning or servicing.



# Installation Instructions

## PREPARE THE OPENING (JCAS445)

- Allow 2" spacing from the range to adjacent vertical walls above the cooktop surface. Allow 30" minimum clearance between the surface units and the bottom of unprotected wood or metal top cabinet, and 18" minimum between the countertop and the adjacent cabinet bottom.
- To eliminate the risk of burns or fire when reaching over hot surface elements, cabinet storage space above the cooktop should be avoided. If cabinet storage space is to be provided above cooktop, the risk can be reduced by installing a range hood that protrudes at least 5" beyond the front of the cabinets. Cabinets installed above a cooktop may be no deeper than 13".

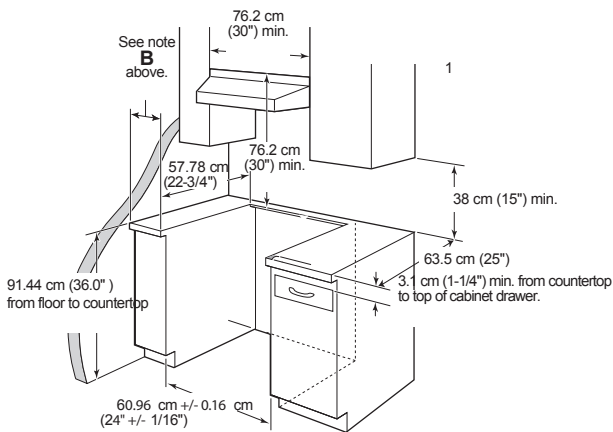

## ELECTRICAL CONNECTIONS

### ELECTRICAL REQUIREMENTS

**⚠ CAUTION:** For personal safety, do not use an extension cord with this appliance. Remove house fuse or open circuit breaker before beginning installation.

This appliance must be supplied with the proper voltage and frequency, and connected to an individual properly grounded branch circuit, protected by a circuit breaker or fuse having amperage as specified on the rating plate. The rating plate is located under the cooktop or in the front frame. (See below pictures).

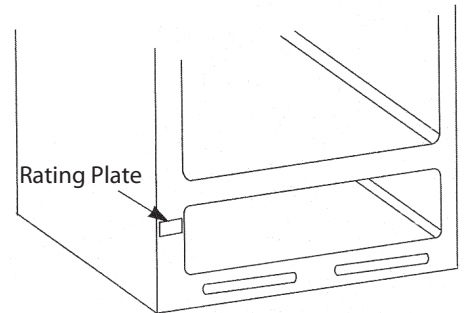
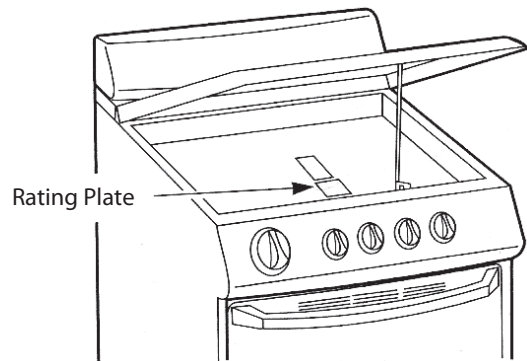

We recommend you have the electrical wiring and hookup of your range connected by a qualified electrician. After installation, have the electrician show you where your main range disconnect is located.

Check with your local utilities for electrical codes which apply in your area. Failure to wire your oven according to governing codes could result in a hazardous condition. If there are no local codes, your range must be wired and fused to meet the requirements of the Canadian Electrical Code, Part 1 Latest Edition.

# Installation Instructions

## INSTALL THE RANGE

### 3 ANTI-TIP DEVICE INSTALLATION

#### ▲ WARNING:

- Range must be secured with an approved Anti-Tip device.
- Unless properly installed, the range could be tipped by you or a child standing, sitting or leaning on an open door.
- After installing the Anti-Tip device, verify that it is in place by carefully attempting to tilt the range forward.
- This range has been designed to meet all recognized industry tip standards for all normal conditions.
- The use of this device does not preclude tipping of the range when not properly installed.

**A** Mark the wall where the **RIGHT EDGE** of the range is to be located. Be sure to allow for the countertop overhang if you intend to install the range next to cabinets.

**B** Locate the outside edge of the device  $2\frac{1}{8}$ " toward the center of the range from the marked edge of the range.

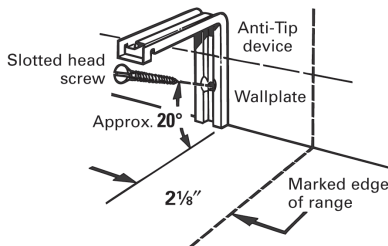

**C** Using the device as template, mark the position of the hole for the screw.

**D** For wood construction, drill a pilot hole at an angle of 20 degrees from the horizontal. A nail or awl may be used if a drill is not available.

Mount the Anti-Tip device with the screw provided.

For cement or concrete construction, you will need

a  $\frac{1}{4}$ " x  $1\frac{1}{2}$ "

lag bolt and

a  $\frac{1}{2}$ " O.D. Sleeve anchor, which are not provided.

Drill the recommended size hole for the hardware.

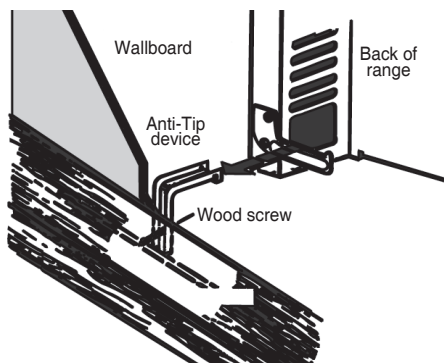

### 3 ANTI-TIP DEVICE INSTALLATION (cont.)

Install the sleeve anchor into the drilled hole and then install the lag bolt through the device. The bolts must be properly tightened as recommended for the hardware.

**E** Slide the range against the wall, and check for proper installation by grasping the front edge of the cooktop and carefully attempting to tilt the range forward.

### 4 LEVEL THE RANGE

For proper cooking and baking, the range must be leveled. Leveling legs are located on each corner at the base of the range.

**A** Install the oven shelves (see Using the oven section for instructions). Put a spirit level or a glass measuring cup partially filled with water on one of the oven shelves.



**B** Turn the legs clockwise to raise the range and counterclockwise to lower the range. Adjust the leveling legs until the range is level.

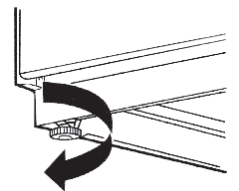

# Installation Instructions

---

## 5 FINAL INSTALLATION CHECKLIST

- Check to make sure the circuit breaker is closed (RESET) or the circuit are replaced.
- Be sure power is in service to the building.
- **Note (on some models):** If the clock flashes “bad” and then “LinE” with a loud tone, the neutral connection to the range is miswired. Check the terminal block connections and/or house wiring to correct.
- Check to be sure that all packing materials and tape have been removed. This will include tape on metal panel under control knobs (if applicable), adhesive tape, wire ties, cardboard and protective plastic. Failure to remove these materials could result in damage to the appliance once the appliance has been turned on and surfaces have heated.
- Check to make sure that the rear leveling leg is fully inserted into the Anti-Tip bracket and that the bracket is securely installed.

## 6 OPERATION CHECKLIST

- Turn on one of the surface to observe that the element glows within 60 seconds. Turn the unit off when glow is detected. If the glow is not detected within the time limit, recheck the range wiring connections. If change is required, retest again. If no change is required, have building wiring checked for proper connections and voltage.
- Check to make sure the Clock (on models so equipped) display is energized. If a series of horizontal red lines appear in the display, disconnect power immediately. Recheck the range wiring connections. IF change is made to connections, retest again. If no change is required, have building wiring checked for proper connections and voltage. It is recommended that the clock be changed if the red lines appear.
- Be sure all range controls are in the OFF position before leaving the range.

## Before you call for service...



### Troubleshooting Tips

Save time and money! Review the charts on the following pages first and you may not need to call for service.

<b>Problem</b>	<b>Possible Causes</b>	<b>What To Do</b>
<b>Radiant Cooktops</b>		
<b>Surface units will not maintain a rolling boil or cooking is not fast enough.</b>	Improper cookware being used.	<ul style="list-style-type: none"> <li>Use pans which are flat and match the diameter of the surface unit selected.</li> </ul>
<b>Surface units do not work properly</b>	A fuse in your home may be blown or the circuit breaker tripped.	<ul style="list-style-type: none"> <li>Replace the fuse or reset the circuit breaker.</li> </ul>
	Cooktop controls improperly set.	<ul style="list-style-type: none"> <li>Check to see the correct control is set for the surface unit you are using.</li> </ul>
<b>Scratches (may appear as cracks) on cooktop glass surface</b>	Incorrect cleaning methods being used.	<ul style="list-style-type: none"> <li>Scratches are not removable. Tiny scratches will become less visible in time as result of cleaning.</li> </ul>
	Cookware with rough bottoms being used or coarse particles (salt or sand) were between the cookware and the surface of the cooktop.  Cookware has been slid across the cooktop surface.	<ul style="list-style-type: none"> <li>To avoid scratches, use the recommended cleaning procedures. Make sure bottoms of cookware are clean before use, and use cookware with smooth bottoms.</li> </ul>
<b>Areas of discoloration on the cooktop</b>	Food spillovers not cleaned before next use.	<ul style="list-style-type: none"> <li>See the <i>Cleaning the glass cooktop section</i>.</li> </ul>
	Hot surface on a model with a light-colored glass cooktop.	<ul style="list-style-type: none"> <li>This is normal. The surface may appear discolored when it is hot. This is temporary and will disappear as the glass cools.</li> </ul>
<b>Plastic melted to the surface</b>	Hot cooktop came into contact with plastic placed on the hot cooktop.	<ul style="list-style-type: none"> <li>See the <i>Glass surface - potential for permanent damage</i> section in the <i>Cleaning the glass cooktop</i> section.</li> </ul>
<b>Pitting (or indentation) of the cooktop</b>	Hot sugar mixture spilled on the cooktop.	<ul style="list-style-type: none"> <li>Call a qualified technician for replacement.</li> </ul>
<b>Frequent cycling off and on of surface units</b>	Improper cookware being used.	<ul style="list-style-type: none"> <li>Use only flat cookware to minimize cycling.</li> </ul>

# Before you call for service...



## Troubleshooting Tips

<b>Problem</b>	<b>Possible Causes</b>	<b>What To Do</b>
<b>Coil Cooktops</b>		
<b>Surface units not functioning properly</b>	The surface units are not plugged in solidly.	<ul style="list-style-type: none"> <li>With the controls off, check to make sure the surface unit is plugged completely into the receptacle.</li> </ul>
	The surface unit controls improperly set.	<ul style="list-style-type: none"> <li>Check to see the correct control is set for the surface unit you are using.</li> </ul>
	The drip pans are not set securely in the cooktop.	<ul style="list-style-type: none"> <li>With the controls off, check to make sure the drip pan is in the recess in the cooktop, and that the opening in the pan lines up with the receptacle.</li> </ul>
<b>Oven-All Models</b>		
<b>Oven light does not work</b>	Light bulb is loose or defective.	<ul style="list-style-type: none"> <li>Tighten or replace the bulb.</li> </ul>
	Switch operating light is broken.	<ul style="list-style-type: none"> <li>Call for service.</li> </ul>
<b>Oven will not work</b>	Plug on range is not completely inserted in the electrical outlet.	<ul style="list-style-type: none"> <li>Make sure electrical plug is plugged into a live properly grounded outlet</li> </ul>
	A fuse in your home may be blown or the circuit breaker tripped.	<ul style="list-style-type: none"> <li>Replaced fuse or reset circuit breaker.</li> </ul>
	Oven controls improperly set.	<ul style="list-style-type: none"> <li>See the <i>Using the oven</i> section.</li> </ul>
	On self-cleaning models door left in the locked position.	<ul style="list-style-type: none"> <li>If necessary, allow the oven to cool then unlock the door.</li> </ul>
<b>Food does not bake or roast properly</b>	Oven controls improperly set.	<ul style="list-style-type: none"> <li>See the <i>Using the oven</i> section.</li> </ul>
	Shelf positions in incorrect or the shelf is not level.	<ul style="list-style-type: none"> <li>See the <i>Using the oven</i> section.</li> </ul>
	Incorrect cookware or cookware of improper size being used.	<ul style="list-style-type: none"> <li>See the <i>Using the oven</i> section.</li> </ul>
	Oven thermostat needs adjustment.	<ul style="list-style-type: none"> <li>See the <i>Adjust the oven thermostat-Easy to do yourself!</i> Section</li> </ul>
<b>No power supply from convenience outlet on top of backguard (on some models)</b>	Small appliance plug is not completely inserted in the convenience outlet.	<ul style="list-style-type: none"> <li>Make sure the small appliance plug is properly inserted.</li> </ul>
	The backguard is too hot and the convenience outlet breaker has tripped.	<ul style="list-style-type: none"> <li>Allow the range to cool, then reset the circuit breaker by pressing the switch located near the convenience outlet.</li> </ul>

Safety Instructions

Operating Instructions

Care and Cleaning

Installation Instructions

Troubleshooting Tips

Consumer Support

## Before you call for service...

<b>Problem</b>	<b>Possible Causes</b>	<b>What To Do</b>
<b>Food does not broil properly</b>	Oven is not set to <b>BROIL</b> .	<ul style="list-style-type: none"> <li>On models with a temperature knob, make sure you turn it all the way to the <b>BROIL</b> position. On models with a <b>BROIL</b> pad, make sure it is turned on.</li> </ul>
	Door not open to the broil stop position as recommended.	<ul style="list-style-type: none"> <li>See the <b>Using the oven</b> section.</li> </ul>
	Improper shelf position being used.	<ul style="list-style-type: none"> <li>See the <b>Broiling guide</b>.</li> </ul>
	Food being cooked in a hot pan.	<ul style="list-style-type: none"> <li>Use the broiling pan and grid that came with your range. Make sure it is cool.</li> </ul>
	Cookware not suited for broiling.	<ul style="list-style-type: none"> <li>Use the broiling pan and grid that came with your range.</li> </ul>
	Aluminium foil used on the broiling pan and grid has not been fitted properly and slit as recommended.	<ul style="list-style-type: none"> <li>See the <b>Using the oven</b> section.</li> </ul>
<b>Control signals after entering cooking time or delay start</b>	In some areas the power (voltage) may be low.	<ul style="list-style-type: none"> <li>Preheat the broil element for 10 minutes.</li> <li>Broil for the longest, period of time recommended in the <b>Broiling guide</b>.</li> </ul>
	You forgot to enter a bake temperature or cleaning time.	<ul style="list-style-type: none"> <li>Press the <b>BAKE</b> pad and desired temperature or the <b>CLEAN</b> pad and desired clean time.</li> </ul>
<b>Display flashes "bAd" then "linE" with a loud tone</b>	The installed connection from the house to the unit is miswired.	<ul style="list-style-type: none"> <li>Contact installer or electrician to correct miswired.</li> </ul>

# Before you call for service...



## Troubleshooting Tips

<b>Problem</b>	<b>Possible Causes</b>	<b>What To Do</b>
<b>Oven temperature too hot or too cold</b>	Oven thermostat needs adjustment.	See the <i>Adjust the oven thermostat-Easy to do yourself!</i> Section
<b>Clock and timer do not work</b>	Plug on range is not completely inserted in the electrical outlet.	Make sure electrical plug is plugged into a live, properly grounded outlet.
	A fuse in your home may be blown or the circuit breaker tripped.	Replace fuse or reset circuit breaker.
	Oven controls improperly set.	See the <i>Using the clock, timer and convenience outlet</i> section.
<b>Display goes blank</b>	A fuse in your home may be blown or the circuit breaker tripped.	Replace fuse or reset circuit breaker.
	The clock is turned off from showing in the display.	See the <i>Using the clock, timer and convenience outlet</i> section.
<b>Oven door is crooked</b>	The door is out of position.	Because the oven door is removable, it sometimes gets out of position during installation. To straighten the door, push down on the high corner.
<b>Oven makes clicking noise</b>	This is the sound of the heating element turning off and on during cooking functions.	This is normal.
<b>"F-and number or letter" flash in the display</b>	<b>You have a function error code.</b>	Press the <b>OFF</b> pad. Put the oven back into operation.
	<b>If the function code repeats:</b>	Disconnected all power to the range for at least 30 seconds and then reconnect power. If the function error code repeats, call for service.  On self-cleaning models, if a function error code appears during the self-cleaning cycle, check the oven door latch. The latch may have been moved, if only slightly, from the locked position. Make sure the latch is moved to the right as far as it will go. Press the <b>OFF</b> pad. Allow the oven to cool for one hour. Put the oven back into operation.
<b>Power outage</b>	Power outage or surge.	Some models will automatically resume their setting once the power is restored. On models with a clock, you must reset the clock. If the oven was in use, you must reset it by pressing the <b>OFF</b> pad, setting the clock and resetting any cooking function.
<b>Display flashes</b>	Power failure.	Reset the clock.
<b>Unable to get the display to show "SF"</b>	Oven control pads were not pressed properly.	The <b>BAKE</b> and <b>BROIL</b> pads must be pressed at the same time and held for 3 seconds.

Safety Instructions

Operating Instructions

Care and Cleaning

Installation Instructions

Troubleshooting Tips

Consumer Support

## Before you call for service...

Safety Instructions			
Operating Instructions	<b>Problem</b>	<b>Possible Causes</b>	<b>What To Do</b>
	"Burning" or "oily" odor emitting from the oven vent	This is normal in a new oven and will disappear in time.	<ul style="list-style-type: none"> <li>To speed the process set a self-clean cycle for a minimum of 3 hours. See the <i>Using the self-cleaning oven</i> section.</li> </ul>
Care and Cleaning	Strong odor	An odor from the insulation around the inside of the oven is normal for the first few times the oven is used.	<ul style="list-style-type: none"> <li>This is temporary.</li> </ul>
	<b>Self-Cleaning Models</b>		
	Oven will not self-clean	The oven temperature is too high to set a self-clean operation.	<ul style="list-style-type: none"> <li>Allow the range to cool to room temperature and reset the controls.</li> </ul>
	Oven starts a self-clean cycle when you wanted to bake, roast or broil	Oven controls improperly set.  Oven door is not in the locked position.	<ul style="list-style-type: none"> <li>See the <i>Using the self-cleaning oven</i> section.</li> <li>Make sure you move the door latch handle all the way to the right.</li> </ul>
Installation Instructions	Oven door locked during cooking.	Oven door locked during cooking.	<ul style="list-style-type: none"> <li>Turn the Oven Temperature knob to <b>OFF</b>. Allow the oven to cool. Never force the door latch handle.</li> </ul>
	"Cracking" or "popping" sound	This is the sound of the metal heating and cooling during both the cooking and cleaning functions.	<ul style="list-style-type: none"> <li>This is normal.</li> </ul>
	Excessive smoking during a clean cycle	Excessive soil.	<ul style="list-style-type: none"> <li>Press the <b>OFF</b> pad. Open the windows to rid the room of smoke. Wait until the light on the <b>CLEAN</b> pad goes off. Wipe up the excess soil and reset the clean cycle.</li> </ul>
Troubleshooting Tips	Oven door will not unlock	Oven too hot.	<ul style="list-style-type: none"> <li>Allow the oven to cool below locking temperature.</li> </ul>
	Oven not clean after a clean cycle	Oven controls not properly set.  Oven was heavily soiled.	<ul style="list-style-type: none"> <li>See <i>Using the self-cleaning oven</i> section.</li> <li>Clean up heavy spillovers before starting the clean cycle. Heavily soiled ovens may need to self-clean again or for a longer period of time.</li> </ul>
	Fan Noise	Humming Noise on Self Clean cycle.	<ul style="list-style-type: none"> <li>This is normal</li> <li>Your range is equipped with a cooling fan to keep the components under safety temperatures. Fan will turn on/off automatically while the range is on Self-Clean cycle.</li> </ul>
Consumer Support		Humming Noise on Bake/Broil	<ul style="list-style-type: none"> <li>This is normal</li> </ul> <p>Cooling Fan will turned-on automatically for Broil Lo/Hi and for High Baking temperatures (around 475° F) in order to maintain safety temperatures for all components.</p> <p>Cooling Fan will turn-off when the oven temperature cools down below 375° F</p>



# Accessories.



## Looking For Something More?

To inquire about purchasing a part or an accessory for your appliance, call our National Parts Center at **1.800.661.1616**.

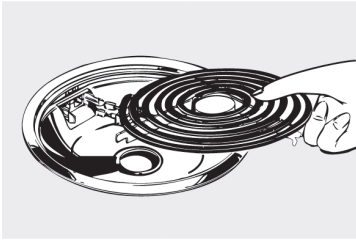

Surface Elements & Drip Pans

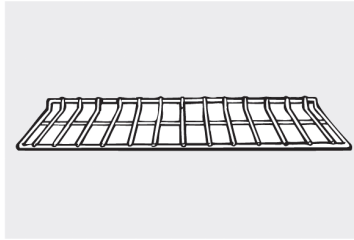

Oven Racks

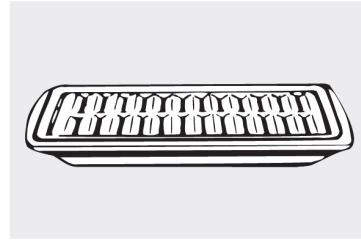

Broiler Pan

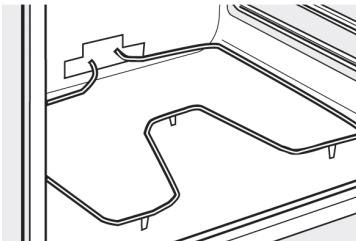

Oven Elements



Light Bulbs



Knobs



Cleaner

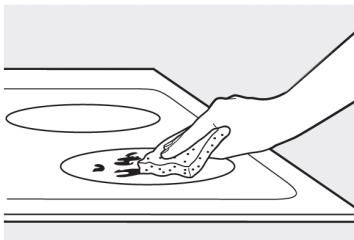

Cleaning Pads

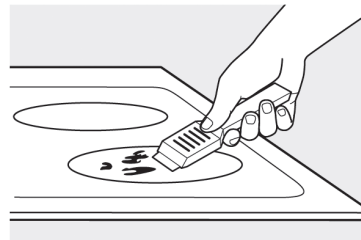

Scraper

Tired of discolored racks? Wishing you had extra-heavy-duty oven racks?

**NOW AVAILABLE** for your range:

GE's innovative, self-cleanable porcelain-coated oven racks!

- Heavy Duty
- Durable
- Able to-be cleaned in a self-cleaning oven

Safety Instructions

Operating Instructions

Care and Cleaning

Installation Instructions

Troubleshooting Tips

Consumer Support



---

*Please place in envelope and mail to:*

*Veillez mettre dans une enveloppe et envoyez à:*

**OWNERSHIP REGISTRATION  
P.O. BOX 1780  
MISSISSAUGA, ONTARIO  
L4Y 4G1**

**(FOR CANADIAN CONSUMERS ONLY –  
POUR RÉSIDENTS CANADIENS SEULEMENT)**

---



For Canadian  
Customer



Pour les  
Consommateurs  
Canadiens

CUT ALONG THIS LINE AND RETURN CARD - THANKS

### OWNERSHIP REGISTRATION CERTIFICATE - FICHE D'INSCRIPTION DU PROPRIÉTAIRE

Please register your product to enable us to contact you in the remote event a safety notice is issued for this product and to allow for efficient communication under the terms of your warranty, should the need arise.

Veillez enregistrer votre produit afin de nous permettre de communiquer avec vous si jamais un avis de sécurité concernant ce produit était émis et de communiquer facilement avec vous en vertu de votre garantie, si le besoin s'en fait sentir.

REGISTER ON-LINE: [www.geappliances.ca](http://www.geappliances.ca) MAIL TO: **P.O. BOX 1780, MISSISSAUGA**  
ENREGISTREMENT SUR INTERNET A: [www.electromenagersge.ca](http://www.electromenagersge.ca) POSTER À: **ONTARIO, L4Y 4G1**

MR./M     MRS./MME.    FIRST NAME/PRENOM    LAST NAME/NOM  
 MISS/Mlle.     MS.

STREET NO./N° RUE    STREET NAME/RUE    APT. NO./APP./RR#

CITY/VILLE    PROVINCE    POSTAL CODE/POSTAL

AREA CODE/IND. RÉG.    TELEPHONE    E-MAIL

DID YOU PURCHASE A SERVICE CONTRACT FOR THIS APPLIANCE?    YES/OUI     IF YES/SI OUI: EXPIRATION  
AVEZ-VOUS ACHETÉ UN CONTRAT DE SERVICE POUR CET APPAREIL?    NO/NON     Y/A    M    D/J

NAME OF SELLING DEALER / NOM DU MARCHAND    MODEL/MODÈLE

INSTALLATION DATE/DATE D'INSTALLATION    CORRESPONDENCE  ENGLISH    SERIAL/SÉRIE  
Y/A    M    D/J    CORRESPONDANCE  FRANCAIS

- I do not wish to receive any promotional offers regarding this product.  
 Je ne désire pas recevoir d'offres promotionnelles concernant ce produit.

# GE Electric Range Warranty.



All warranty service provided by our Factory Service Centers, or an authorized Customer Care technician. To schedule service, 24 hours a day, call 1.800.561.3344. Please have serial number and model number available when calling for service.

Staple your receipt here. Proof of the original purchase, date is needed to obtain service under the warranty.

## For The Period Of: Mabe Canada Will Provide:

**One year**  
From the date of the original purchase.

**Any part** of the range which fails due to a defect in materials or workmanship. During this **limited one-year warranty**. Mabe will also provide, **free of charge**, all labor and related service to replace the defective part.

## What Mabe Canada Will Not Cover:

- Service trips to your home to teach you how to use the product.
- Improper installation, delivery or maintenance.
- Failure of the product if it is abused, misused, or used for other than the intended purpose or used commercially.
- Damage to the glass cooktop caused by use of cleaners other than the recommended cleaning creams and pads.
- Damage the glass cooktop caused by hardened spills of sugary materials or melted plastic that are not cleaned according to the directions in the Owner's Manual.
- Replacement of house fuses or resetting of circuit breakers.
- Damage to the product caused by accident, fire, floods or acts of God.
- Incidental or consequential damage caused by possible defects with this appliance.
- Damage caused after delivery.
- Product not accessible to provide required service.

**EXCLUSION OF IMPLIED WARRANTIES-Your sole and exclusive remedy is product repair as provided in this Limited Warranty. Any implied warranties, including the implied warranties of merchantability or fitness for a particular purpose, are limited to one year or the shortest period allowed by law.**

This warranty is extended to the original purchaser and any succeeding owner for products purchased for home use within Canada. In-home warranty service will be provided in areas where it is available and deemed reasonable by Mabe Canada to provide.

Some provinces do not allow the exclusion or limitation of incidental or consequential damages, so the above limitation or exclusion may not apply to you. This warranty gives you specific legal rights, and you may also have other rights which vary from province to province. To know what your legal rights are in your province, consult your local or provincial consumer affairs office.

**Warrantor: Mabe Canada Inc.,  
Burlington, Ontario**

Safety Instructions

Operating Instructions

Care and Cleaning

Installation Instructions

Troubleshooting Tips

Consumer Support

## Consumer Support.

---



[www.GEAppliances.ca](http://www.GEAppliances.ca)

Have a question or need assistance with your appliance? Try the GE Appliance Website 24 hours a day, any day of the year! For greater convenience and faster service, you can now download Owner's Manuals on-line. You can also "Ask Our Team of Experts <sup>TM</sup>" your questions, and so much more...



### *Schedule Service*

[www.GEAppliances.ca](http://www.GEAppliances.ca)

Expert GE repair service is only one step away from your door. Call 1-800-561-3344, 24 hours a day, 7 days a week.

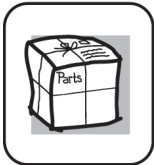

### *Parts and Accessories*

[www.GEAppliances.ca](http://www.GEAppliances.ca)

To inquire about purchasing a part or a accessory for your appliance, call our National Parts Center at 1-800-661-1616.



### *Contact Us*

[www.GEAppliances.ca](http://www.GEAppliances.ca)

If you are not satisfied with the service you receive from GE, contact us on our Website with all the details including your phone number, or write to: Mabe Canada, Inc.

1 Factory Lane  
Moncton, New Brunswick  
E1C9M3



### *Register Your Appliance*

[www.GEAppliances.ca](http://www.GEAppliances.ca)

Register your new appliance on-line-at your convenience! Timely product registration will allow for enhanced communication and prompt service under the terms of your warranty, should the need arise. You may also mail in the preprinted registration card included in the packing material.