

Installation Instructions

36" Electric Cooktop -Radiant

Excludes Down-Draft Models



If you have questions, call 800.GE.CARES or visit our website at: GEAppliances.com.

In Canada, call 800.561.3344 or visit our website at: GEAppliances.ca.

BEFORE YOU BEGIN

Read these instructions completely and carefully.

- **IMPORTANT** – Save these instructions for local inspector's use.
- **IMPORTANT** – Observe all governing codes and ordinances.
- **Note to Installer** – Be sure to leave these instructions with the Consumer.
- **Note to Consumer** – Keep these instructions for future reference.
- Product failure due to improper installation is not covered under the Warranty.

⚠ WARNING – This appliance must be properly grounded.

• **ATTENTION INSTALLER** – ALL COOKTOPS MUST BE HARD WIRED (DIRECT WIRED) INTO AN APPROVED JUNCTION BOX. A "PLUG AND RECEPTACLE" IS NOT PERMITTED ON THESE PRODUCTS.

- Proper installation is the responsibility of the installer and product failure due to improper installation is NOT covered under warranty.

MATERIALS YOU WILL NEED

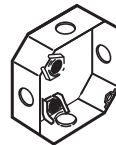

Junction Box



Wire Nuts

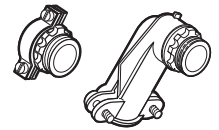

90° or Straight Squeeze Connector for 1" Conduit

TOOLS YOU WILL NEED



Pencil



Phillips Head Screwdriver

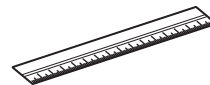

Ruler or Straightedge



Safety Glasses

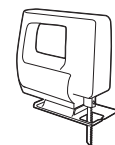

Saber Saw

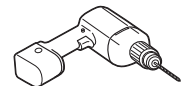

1/8" Drill Bit & Electric or Hand Drill

PARTS INCLUDED

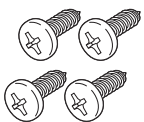

4 Screws
(WB01X1137)

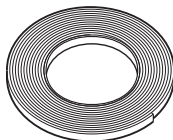

Foam Tape
WB06K5042

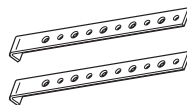

2 Hold Down
Brackets

Installation Instructions

IMPORTANT SAFETY INSTRUCTIONS

FOR YOUR SAFETY

- For Personal Safety, remove house fuse or open circuit breaker before beginning installation. Failure to do so could result in serious injury or death.
- Be sure your cooktop is installed properly by a qualified installer or service technician.
- To eliminate the risk of burns or fire due to reaching over heated surface elements, cabinet storage located above the surface units should be avoided. If cabinet storage space is to be provided, the risk can be reduced by installing a range hood that projects horizontally a minimum of 5" beyond the bottom of the cabinets. Cabinet installation above the cooktop may be no deeper than 13".
- Make sure the cabinets and wall coverings around the cooktop can withstand the temperatures (up to 200°F) generated by the cooktop.
- The cooktop should be easy to reach and lighted with natural light during the day.
- Always disconnect the electrical service to the cooktop before repairing or servicing the cooktop. This can be done by disconnecting the fuse or circuit breaker. Failure to do this could result in a dangerous or fatal shock. Know where your main disconnect switch is located. If you do not know, have your electrician show you.

ELECTRICAL REQUIREMENTS

This appliance must be supplied with the proper voltage and frequency, and connected to an individual, properly grounded branch circuit, protected by a circuit breaker or a time delay fuse as noted on name plate.

We recommend you have the electrical wiring and hookup of your cooktop connected by a qualified electrician. After installation, have the electrician show you where your main cooktop disconnect is located.

Wiring must conform to National Electrical Code. You can get a copy of the National Electrical Code, ANSI/NFPA No. 70-Latest Edition, by writing:

National Fire Protection Association
Batterymarch Park
Quincy, MA 02269

The cooktop conduit wiring is approved for copper wire connection only, and if you have aluminum house wiring, you must use special UL approved connectors for joining copper to aluminum.

You must use a two-wire, three conductor 208/240 VAC, 60 Hertz electrical system. A white (neutral) wire is not needed for this unit. The cooktop must be installed in a circuit that does not exceed 125 VAC nominal to ground.

Refer to the name plate on your cooktop for the KW rating for your cooktop.

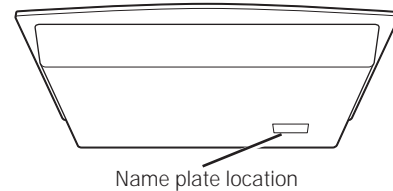

Installation Instructions

PRE-INSTALLATION CHECKLIST

⚠ WARNING – The electrical power to the cooktop supply line must be shut off while connections are being made. Failure to do so could result in serious injury or death.

- A** When preparing cooktop opening, make sure the inside of the cabinet and the cooktop do not interfere with each other. (See section on preparing the opening.)
- B** Remove packaging materials and literature package from the cooktop before beginning installation.

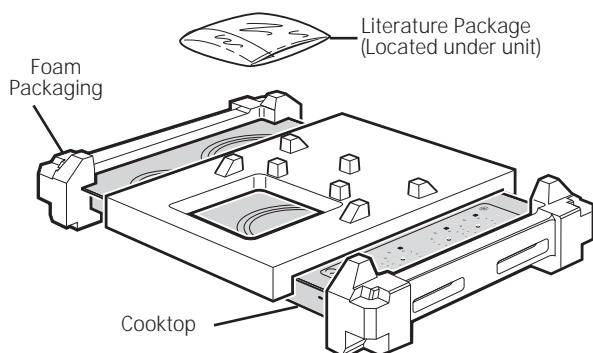

- C** Be sure to place all literature, Owner's Manual, Installations, etc. in a safe place for future reference.
- D** Make sure you have all the tools and materials you need before starting the installation of the cooktop.
- E** Your home must provide the adequate electrical service needed to safely and properly use your cooktop. (Refer to section on electrical requirements.)

- F** When installing your cooktop in your home, make sure all local codes and ordinances are followed exactly as stated.
- G** Make sure the wall coverings, countertop and cabinets around the cooktop can withstand heat (up to 200°F) generated by the cooktop.
- H** **Installing cooktop in combination with other products.** Both products must be installed according to their specific product installation instructions. Consideration must be given the separate electrical requirements and locations:

Over one or two wall ovens:

- Only certain models may be installed over wall ovens. The wall oven and cooktop will both have a label stating which models are approved in combination.

Over a Microwave:

- See microwave installation instructions for how to install a microwave under a cooktop. For vertical dimension of cooktop, see Approximate Cooktop Dimensions section.

In combination with telescopic downdraft vent:

- See telescopic downdraft vent instructions for how to install a vent behind a cooktop.
- The countertop must have a deep flat surface to accommodate the combined installation of the cooktop and vent.

Over a warming drawer:

- See warming drawer instructions for how to install a warming drawer under a cooktop. For vertical dimension of cooktop, see Approximate Cooktop Dimensions section.

PREPARING THE OPENING

- 1** The following MINIMUM clearance dimensions must be maintained.

If a 30" clearance between the cooking surface and overhead combustible materials or metal cabinets cannot be maintained, a minimum clearance of 24" is required and the underside of the cabinets above the cooktop must be protected with not less than 1/4" insulating millboard covered with sheet metal not less than 0.0122" thick.

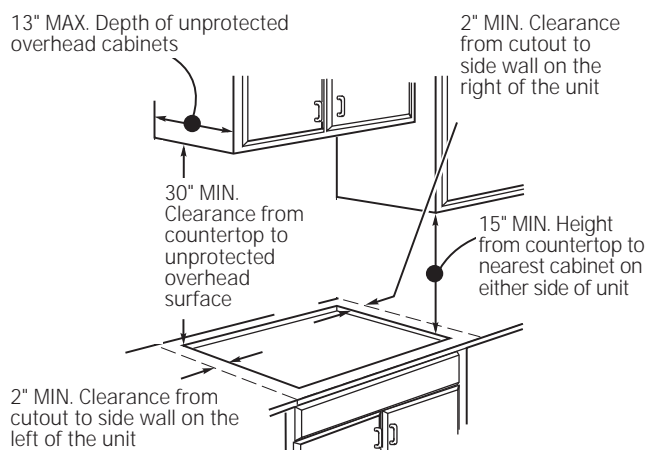

Installation Instructions

PREPARING THE OPENING (CONT)

2 APPROXIMATE COOKTOP DIMENSIONS

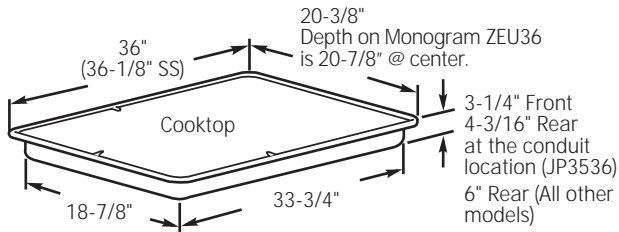

3 VERTICAL CLEARANCE

Allow 5" minimum vertical clearance from the cooktop bottom (or 8-1/4" minimum depth from the countertop) to any combustible surfaces, such as a cabinet drawer.

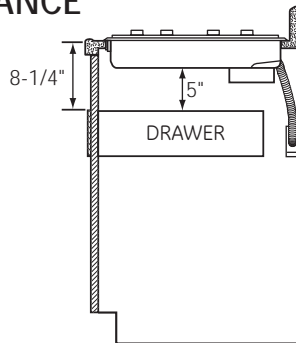

4 CUTOUT DIMENSIONS OF THE COUNTERTOP

To insure accuracy, it is best to make a template when cutting the opening in the counter.

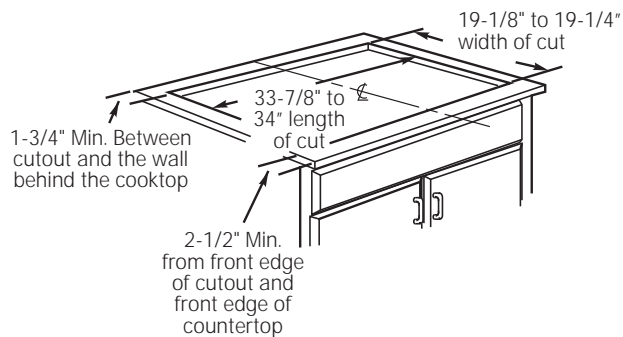

- 5 Make sure the wall coverings, countertop and cabinets around the cooktop can withstand heat (up to 200°F) generated by cooktop.

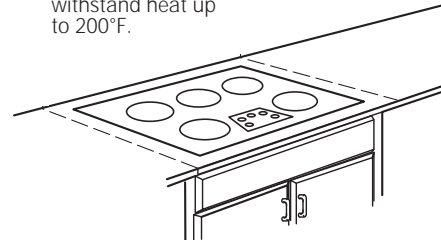
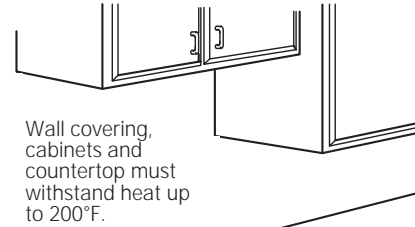

- 6 For Americans with Disabilities Act (ADA) Forward Approach Installation Only:

For models with no drop box, allow 5" minimum depth between the countertop and an enclosure (JP3536).

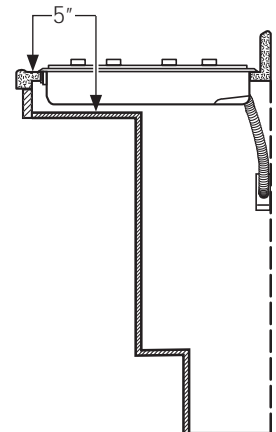

For electronic touch and backlit knob models, allow 6-1/2" minimum depth between the countertop and an enclosure. (All other models)

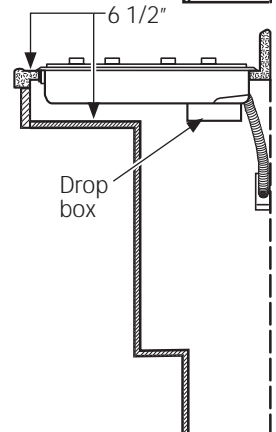

NOTE: The enclosure must be made of wood material. Also, an access panel is required for the junction box, hold-down brackets, and service.

Installation Instructions

INSTALLING THE COOKTOP

1 INSTALLING THE JUNCTION BOX

Install an approved junction box where it will be easily reached through the front of the cabinet where the cooktop will be located. **The cooktop conduit is 4 feet long.**

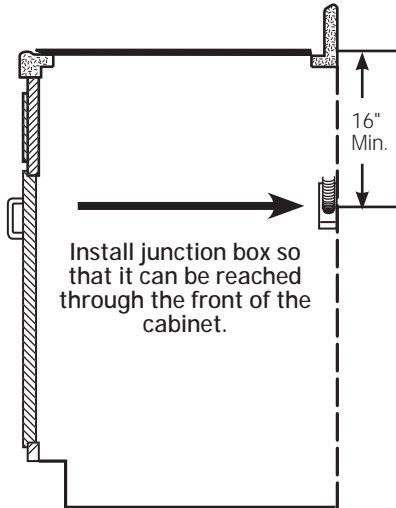

▲ IMPORTANT: The junction box must be located where it will allow considerable slack in the conduit for serviceability.

2 PROTECT SURFACE OF COOKTOP

Place a towel or tablecloth onto the countertop. Lay the cooktop upside down onto the protected surface.

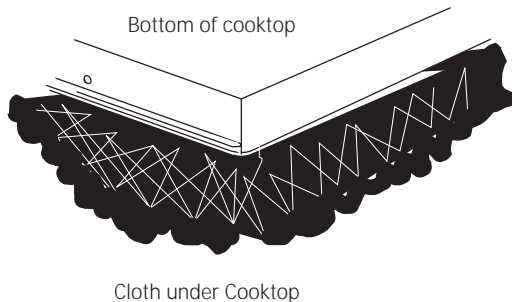

3 ATTACH FOAM TAPE

Apply the foam tape around the outer edge of the glass. **Do not overlap the foam tape.**

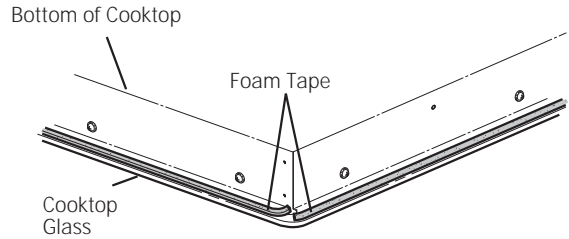

Note: On ZEU36 model, apply the foam tape around the outer edge of the glass on the sides and rear of the unit only.

4 LOCATE MOUNTING PARTS

Remove the hold down brackets and screws from the literature package.



Screw the Hold Down Bracket to the side of the cooktop unit. Repeat for opposite side of cooktop.

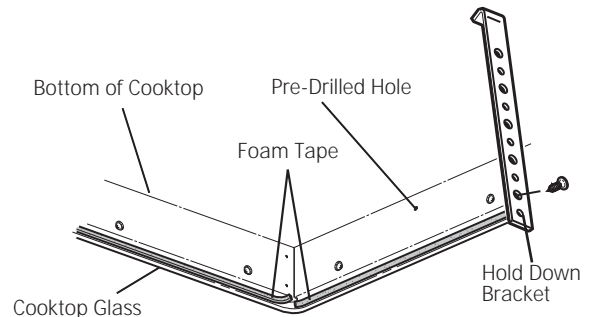

Installation Instructions

INSTALLING THE COOKTOP (CONT.)

4 LOCATE MOUNTING PARTS (Cont.)

Alternate Installation:

You can order an alternate installation kit WB01X25470 with wing nuts and brackets from your dealer. See diagram for instructions.

Open the cabinet door. Install the second screw through the bracket and tighten. Then tighten the first screw. Install thumbscrew until it touches the bottom of the countertop.

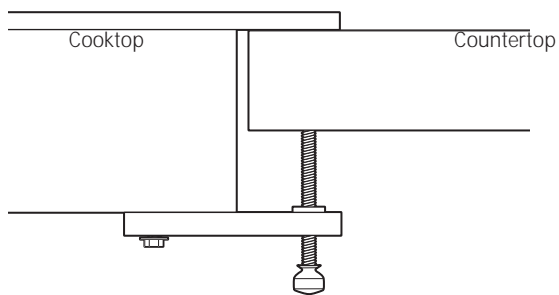

IMPORTANT: Turn the thumbscrew until it touches the bottom of the countertop. Do not overtighten.

5 INSERT COOKTOP INTO CUTOUT

Insert the cooktop centered into the cutout opening. Make sure the front edge of the countertop is parallel to the cooktop. Make final check that all required clearances are met.

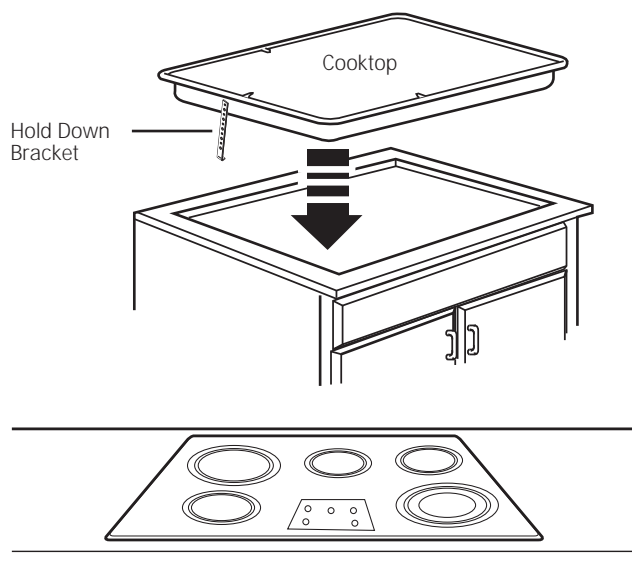

Attach Hold Down Brackets to cabinet.

A When making the wire connections, use the entire length of conduit provided. **The conduit must not be shortened.**

B With the cooktop in place, open the front of the cabinet door.

C Insert the wires from the conduit through the opening of the junction box.

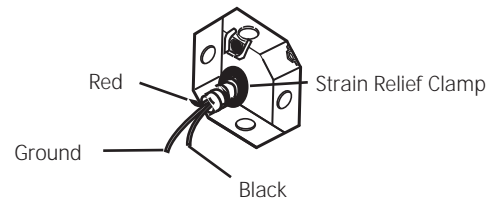

D Connect the red and black leads from the cooktop conduit to the corresponding leads in the junction box.

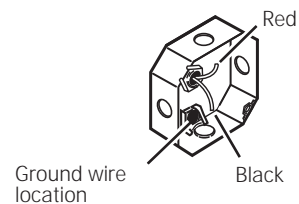

E Once the connections are made, secure wires together using wire nuts.

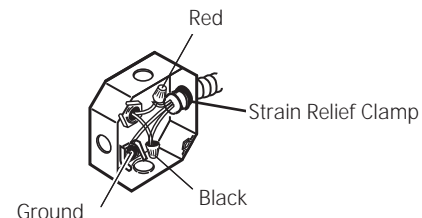

Installation Instructions

INSTALLATION—ELECTRICAL CONNECTIONS

GROUNDING INSTRUCTIONS:

The bare ground wire in the conduit is connected to the cooktop frame. Effective January 1, 1996, the National Electrical Code will not permit grounding through neutral.

If used in new construction after January 1, 1996 or in a mobile home, recreational vehicle or if local codes do not permit grounding through the neutral white lead, attach the appliance grounding lead (green or copper) to the residence grounding conductor (green or bare copper) in accordance with local codes. When connecting to a 3 conductor branch circuit, if local codes permit, connect the bare ground connector lead of the cooktop to the branch circuit neutral (gray or white in color).

⚠ IMPORTANT: If the cooktop is being installed into a blind counter (one with no cabinet opening below), wire connections must be made before putting the cooktop into the cutout opening.

Installation Instructions

CHECKLISTS

1 PRE-TEST CHECKLIST

- A** Remove all protective film, if present, and any stickers.
- B** Check to be sure that all wiring is secure and not pinched or in contact with moving parts.
- C** Check level of appliance.
- D** Check that the cooktop is properly grounded.

2 OPERATION CHECKLIST

- A** Remove all items from the top of the cooktop surface.
- B** Turn on the power to the cooktop. (Refer to your Owner's Manual.) Verify that all surface burners operate properly.
- C** Check that the circuit breaker is not tripped nor the house fuse blown.
- D** Check that conduit is securely connected to the junction box.

NOTE TO ELECTRICIAN:

The power leads supplied with this appliance are UL recognized for connections to larger gauge household wiring. The insulation of these leads is rated at temperatures much higher than the temperature rating of household wiring. The current carrying capacity of a conductor is governed by the wire gauge and also the temperature rating of the insulation around the wire.

NOTE: ALUMINUM WIRING

- **WARNING:**
IMPROPER CONNECTION OF ALUMINUM HOUSE WIRING TO THE COPPER LEADS CAN RESULT IN A SERIOUS PROBLEM.
- Splice copper wires to aluminum wiring using special connectors designed and UL approved for joining copper to aluminum and follow the manufacturer's recommended connector procedure closely.

NOTE: Wire used, location and enclosure of splices, etc., must conform to good wiring practice and local codes.