



Range Hoods

Safety Information 2

Operating/Care and Cleaning Instructions

Charcoal Filter 4
Grease Filter 3
Hood Light 4
Hood Surfaces 4
Controls 3

Installation Instructions 5-13

Consumer Support

Consumer Support Back Cover
Warranty 15

Owner's Manual and Installation Instructions

- JV247*-Vent & Recirculation options
- JV248*-Vent & Recirculation options
- JN327-Recirculation only
- JV338*-Vent options only
- JV347*-Vent & Recirculation options
- JV348*-Vent & Recirculation options
- JV367*-Vent & Recirculation options
- RN328-Recirculation only



Write the model and serial numbers here:

Model # _____

Serial # _____

You can find them on a label on the back wall of the hood.

IMPORTANT SAFETY INFORMATION. READ ALL INSTRUCTIONS BEFORE USING.



SAFETY PRECAUTIONS

⚠ WARNING – TO REDUCE THE RISK OF FIRE, ELECTRIC SHOCK OR INJURY TO PERSONS, OBSERVE THE FOLLOWING:

- A. Use this unit only in the manner intended by the manufacturer. If you have questions, contact the manufacturer.
- B. Before servicing or cleaning unit, switch power off at service panel and lock the service disconnecting means to prevent power from being switched on accidentally. When the service disconnecting means cannot be locked, securely fasten a prominent warning device, such as a tag, to the service panel.
- C. Do not use this unit with any solid-state speed control device.
- D. If using a cord connection kit, use only with range hood cord-connection kit JXHC1 that has been investigated and found acceptable for use with this model range hood.
- E. This unit must be grounded.

⚠ CAUTION – FOR GENERAL VENTILATING USE ONLY. DO NOT USE TO EXHAUST HAZARDOUS OR EXPLOSIVE MATERIALS AND VAPORS.

⚠ WARNING – TO REDUCE THE RISK OF INJURY TO PERSONS IN THE EVENT OF A RANGE TOP GREASE FIRE, OBSERVE THE FOLLOWING*:

- A. SMOTHER FLAMES with a close-fitting lid, cookie sheet or metal tray, then turn off the burner. BE CAREFUL TO PREVENT BURNS. If the flames do not go out immediately, EVACUATE AND CALL THE FIRE DEPARTMENT.
- B. NEVER PICK UP A FLAMING PAN— You may be burned.
- C. DO NOT USE WATER, including wet dishcloths or towels—a violent steam explosion will result.
- D. Use an extinguisher ONLY if:
 1. You know you have a Class ABC extinguisher, and you already know how to operate it.
 2. The fire is small and contained in the area where it started.
 3. The fire department is being called.
 4. You can fight the fire with your back to an exit.

* Based on "Kitchen Firesafety Tips" published by NFPA.

⚠ WARNING – TO REDUCE THE RISK OF A RANGE TOP GREASE FIRE:

- A. Never leave surface units unattended at high settings. Boilovers cause smoking and greasy spillovers that may ignite. Heat oils slowly on low or medium settings.
- B. Always turn hood ON when cooking on high heat or when flambeing food (i.e. Crepes Suzette, Cherries Jubilee, Peppercorn Beef Flambe).
- C. Clean ventilating fans frequently. Grease should not be allowed to accumulate on fan or filter.
- D. Use proper pan size. Always use cookware appropriate for the size of the surface element.

⚠ WARNING – TO REDUCE THE RISK OF FIRE, ELECTRIC SHOCK OR INJURY TO PERSONS, OBSERVE THE FOLLOWING:

- A. Installation work and electrical wiring must be done by qualified person(s) in accordance with all applicable codes and standards, including fire-rated construction.
- B. Sufficient air is needed for proper combustion and exhausting of gases through the flue (chimney) of fuel burning equipment to prevent back drafting. Follow the heating equipment manufacturer's guideline and safety standards such as those published by the National Fire Protection Association (NFPA), the American Society for Heating, Refrigeration and Air Conditioning Engineers (ASHRAE) and the local code authorities.
- C. When cutting or drilling into wall or ceiling, do not damage electrical wiring and other hidden utilities.
- D. Ducted fans must always be vented to the outdoors.

⚠ WARNING – TO REDUCE THE RISK OF FIRE AND TO PROPERLY EXHAUST AIR, BE SURE TO DUCT AIR OUTSIDE—DO NOT VENT EXHAUST AIR INTO SPACES WITHIN WALLS OR CEILINGS OR INTO ATTICS, CRAWL SPACES OR GARAGES.

⚠ WARNING – TO REDUCE THE RISK OF FIRE, USE ONLY METAL DUCTWORK.

- Do not attempt to repair or replace any part of your hood unless it is specifically recommended in this guide. All other servicing should be referred to a qualified technician.



READ AND FOLLOW THIS SAFETY INFORMATION CAREFULLY.
READ AND SAVE THESE INSTRUCTIONS

Using the hood controls.

Throughout this manual, features and appearance may vary from your model.

Control Knobs (on some models)

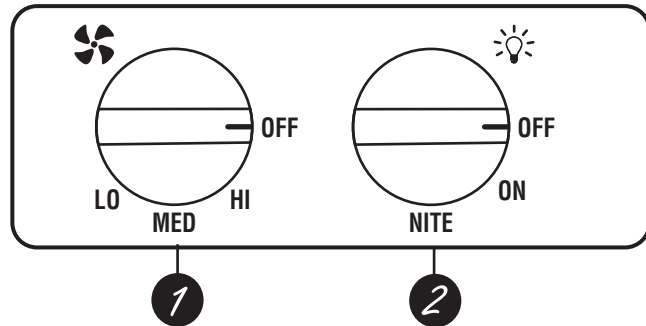

1 FAN Control

Turn to **HI**, **MED** or **LO** as needed.

Continuous use of the fan system while cooking helps keep the kitchen comfortable and less humid. It also reduces cooking odors and soiling moisture that create a frequent need for cleaning.

2 LIGHT Control

Turn to **ON** while cooking or to **NITE** for use as a night light.

Switch Pad Controls (on some models)

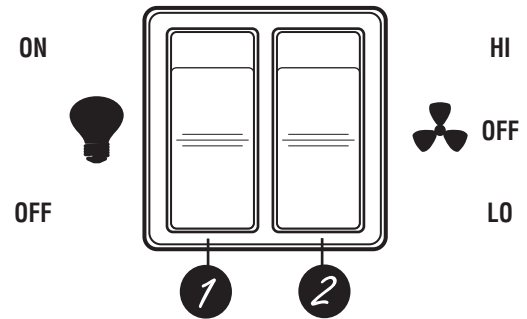

1 LIGHT Control

Press the pad at the top to turn the light **ON**.

2 FAN Control

Press the pad at the top to turn the fan on **HI** and at the bottom to turn it on **LO**. The center position is **OFF**.

Continuous use of the fan system while cooking helps keep the kitchen comfortable and less humid. It also reduces cooking odors and soiling moisture that create a frequent need for cleaning.

Care and cleaning of the vent hood.

Be sure electrical power is off and all surfaces are cool before cleaning or servicing any part of the vent hood.

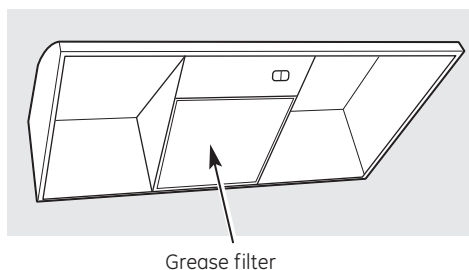

Reusable Metal Grease Filter—Ducted Installations Only

The efficiency of your hood depends on a clean filter. Frequency of cleaning depends on hood use and the type of cooking you do. **However, the grease filter should be cleaned at least once a month.**

To remove:

Pull down on the center of the front edge of the filter. The filter will then slip out of the retaining tabs on the back.

To replace:

Slip the back edge of the filter into the retaining tabs and push the front edge up until it snaps into place.

To clean:

Soak and then agitate it in a hot water and detergent solution. Light brushing can be used to remove embedded dirt. Rinse, shake and let it dry before replacing.

NEVER OPERATE THE HOOD WITHOUT THE FILTER IN PLACE.

With careful handling, the metal filter will last for years. If a new replacement filter becomes necessary, order the part from your dealer. Order genuine GE part number **WB02X8391**.

Using the hood controls.

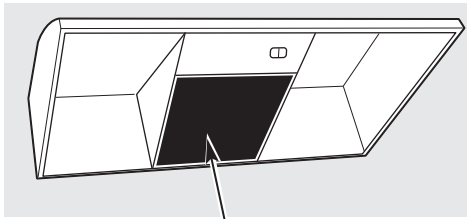

Replaceable charcoal filter

NOTE: DO NOT rinse, or put charcoal filters in an automatic dishwasher.

Charcoal Filter—Recirculating Installations Only

The charcoal filter cannot be cleaned. It must be replaced. Order filter no. **WB02X10700**. Replacement filters can be ordered from your GE supplier.

If the hood is not vented to the outside, the air will be recirculated through a disposable charcoal filter that helps remove smoke and odors.

The charcoal filter should be replaced after 6 to 12 months (depending on hood usage).

To remove:

Pull down on the center of the front edge of the filter. The filter will then slip out of the retaining tabs on the back.

To replace:

Slip the back edge of the filter into the retaining tabs and push the front edge up until it snaps into place.

Stainless Steel Surfaces (on some models)

Do not use a steel-wool pad; it will scratch the surface.

To clean the stainless steel surface, use warm sudsy water or a stainless steel cleaner or polish. Always wipe the surface in the direction of the grain. Follow the cleaner instructions for cleaning the stainless steel surface.

To inquire about purchasing stainless steel appliance cleaner or polish, or to find the location of a dealer nearest you, please call our toll-free number:

National Parts Center 800.661.1616
GEAppliances.ca

Painted Surfaces (on some models)

Do not use steel-wool pads or other abrasive cleaners. They will scratch the surface.

Clean grease-laden surfaces of the hood frequently. To clean the hood surface, use a hot, damp cloth with a mild detergent suitable for painted surfaces. About one tablespoon of ammonia may be added to the water. Use a clean, hot, damp cloth to remove soap. Dry with a dry, clean cloth.

NOTE: When cleaning, take care not to come in contact with filters and other non-enameled surfaces.

CAUTION: When cleaning the hood surfaces, be certain that you do not touch the light bulb with moist hands or cloth. A warm or hot light bulb may break if touched with a moist surface. Always let the light bulb cool completely before cleaning around it.

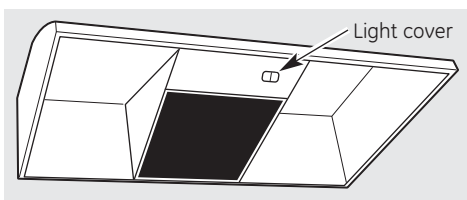

Light cover

Hood Light

CAUTION: Let the light bulb cool completely before removing. A warm or hot bulb may break if touched with a moist cloth or hand.

Remove the bulb and replace it with a type **A15** incandescent light bulb with an ordinary screw base, **not more than 60 Watts**, or a type **A17** or **T2** Compact Fluorescent (CFL) light bulb with an ordinary screw base, **not more than 13 Watts**. **NOTE:** Use **only** incandescent bulbs in models RN328, JN327 and JV338.

IMPORTANT: For installation, handling and disposal precautions, refer to the fluorescent bulb packaging literature.

To remove the light cover (on some models):

- Press the sides with two fingers until the side prongs are released.
- Lift the light cover and slide it toward you in one motion.

To replace the light cover:

- Insert the prong located at the end of the cover into the top opening.
- Gently push the cover up and press the sides to fit the side prongs into the side openings.
- Release and the cover will lock in position.

When using an energy saving bulb in your GE hood make sure you use either:

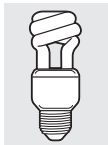

GE Long Life Energy Smart™ Spiral® T2
Product Code: 85383
Description: FLE13HT2/2/SW/CD

or

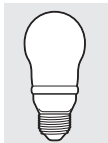

GE Long Life Energy Smart™ A17
Product Code: 47486
Description: FLE11/2/A17XL/CD
Visit your local Mabe Parts Store.

Installation Instructions

Range Hood

Questions? Call 800.561.3344 or visit our Website at: GEAppliances.ca

BEFORE YOU BEGIN

Read these instructions completely and carefully.

- **IMPORTANT** – Save these instructions for local inspector's use.
- **IMPORTANT** – Observe all governing codes and ordinances.
- **Note to Installer** – Be sure to leave these instructions with the Consumer.
- **Note to Consumer** – Keep these instructions for future reference.
- **Skill level** – Installation of this appliance requires basic mechanical and electrical skills.
- **Completion time** – 30 minutes–3 hours
- Proper installation is the responsibility of the installer.
- Product failure due to improper installation is not covered under the Warranty.

FOR YOUR SAFETY:

⚠ WARNING – Before beginning the installation, switch power off at service panel and lock the service disconnecting means to prevent power from being switched on accidentally. When the service disconnecting means cannot be locked, securely fasten a prominent warning device, such as a tag, to the service panel.

OPTIONAL POWER CORD KIT JXHC1

An optional Power Cord Connection Kit, model JXHC1, is available at extra cost from your Mabe Parts Store for installation using a standard 3-prong, grounded wall outlet. Follow the Installation Instructions packed with the kit to connect the power cord to the range hood.

DUCTWORK REQUIREMENTS

NOTE: Read the ductwork sections only if you do not have existing ductwork. If you have existing ductwork, skip to the "Damage" section and proceed.

⚠ WARNING – TO REDUCE THE RISK OF FIRE AND TO PROPERLY EXHAUST AIR, BE SURE TO DUCT AIR OUTSIDE—DO NOT VENT EXHAUST AIR INTO SPACES WITHIN WALLS OR CEILINGS OR INTO ATTICS, CRAWL SPACES OR GARAGES.

The venting system must exhaust to the outside.

This hood can be vented vertically through upper cabinets or horizontally through an outside wall. Ductwork is not included.

Exhaust connection:

The hood exhaust has been designed to mate with standard 3¼" x 10" rectangular ducting or 7" diameter round ducting.

If a 6" round duct is required, a rectangular-to-round transition adaptor must be used*. **Do not use less than a 6" diameter duct.**

Maximum duct length:

For satisfactory air movement, the total duct length of a 3¼" x 10" rectangular, 6" or 7" diameter round duct **should not exceed 65 equivalent feet**. See the **WORKSHEET—CALCULATE TOTAL EQUIVALENT DUCTWORK LENGTH** section.

NOTE: It is important that ducting be installed using the most direct route and with as few elbows as possible. This ensures clear venting of exhaust and helps prevent blockages. **Also, make sure dampers swing freely and nothing is blocking the ducts.**







Elbows, transitions, wall and roofcaps, etc., present additional resistance to airflow and are equivalent to a section of straight duct longer than their actual physical size. When calculating the total duct length, add the equivalent lengths of all transitions and adaptors plus the length of all straight duct sections. The charts on the following pages show you how to calculate total equivalent ductwork length using the approximate feet of equivalent length of some typical ducts.



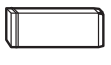
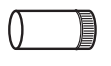
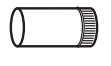
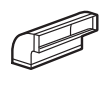
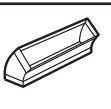







*** IMPORTANT:** If a rectangular-to-round transition adaptor is used, the bottom corners of the damper will have to be cut to fit, using the tin snips, in order to allow free movement of the damper. Equivalent lengths of duct pieces are based on actual tests and reflect requirements for good venting performance with any hood.

Installation Instructions

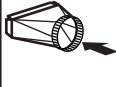
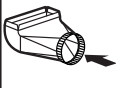
WORKSHEET—CALCULATE TOTAL EQUIVALENT DUCTWORK LENGTH

DUCT PIECES		EQUIVALENT LENGTH	x USED	=	TOTAL
	3 1/4" x 10" Rect., straight	1 Ft.	x ()	=	Ft.
	7" Round, straight	1 Ft.	x ()	=	Ft.
	6" Round, straight	1 Ft.	x ()	=	Ft.
	3 1/4" x 10" Rect. 90° elbow	14 Ft.	x ()	=	Ft.
	3 1/4" x 10" Rect. 45° elbow	8 Ft.	x ()	=	Ft.
	3 1/4" x 10" Rect. 90° flat elbow	33 Ft.	x ()	=	Ft.
	3 1/4" x 10" Rect. wall cap with damper	24 Ft. (18 ft. w/o damper)	x ()	=	Ft.
	3 1/4" x 10" Rect. to 6" round transition	2 Ft.	x ()	=	Ft.
	3 1/4" x 10" Rect. to 6" round transition 90° elbow	4 Ft.	x ()	=	Ft.
	6" Round, 90° elbow	25 Ft.	x ()	=	Ft.
	6" Round, 45° elbow	16 Ft.	x ()	=	Ft.
Subtotal column 1				=	Ft.

MAXIMUM DUCT LENGTH: For satisfactory air movement, the total duct length of a 3 1/4" x 10" rectangular, 7" diameter round duct **should not exceed 65 equivalent feet.**

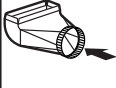
DUCT PIECES		EQUIVALENT LENGTH	x USED	=	TOTAL
	6" Round wall cap with damper	53 Ft. (39 ft. w/o damper)	x ()	=	Ft.
	6" Round roof cap	72 Ft.	x ()	=	Ft.
	6" Round to 3 1/4" x 10" rect. transition	3 Ft.	x ()	=	Ft.
	6" Round to 3 1/4" x 10" rect. transition 90° elbow	9 Ft.	x ()	=	Ft.
	7" Round, 90° elbow	14 Ft.	x ()	=	Ft.
	7" Round, 45° elbow	9 Ft.	x ()	=	Ft.
	7" Round wall cap with damper	28 Ft. (21 ft. w/o damper)	x ()	=	Ft.
	7" Round roof cap	39 Ft.	x ()	=	Ft.
	7" Round to 3 1/4" x 10" rect. transition	1 Ft.	x ()	=	Ft.
	7" Round to 3 1/4" x 10" rect. transition, 90° elbow	5 Ft.	x ()	=	Ft.
Subtotal column 2				=	Ft.
Subtotal column 1				=	Ft.
Total ductwork				=	Ft.

1 ft = 0.3 m; 1 in. = 2.5 cm

Installation Instructions

DAMAGE – SHIPMENT/INSTALLATION

- If the unit is damaged in shipment, return the unit to the store in which it was bought for repair or replacement. Call 800.531.3344.
- If the unit is damaged by the customer, repair or replacement is the responsibility of the customer.
- If the unit is damaged by the installer (if other than the customer), repair or replacement must be made by arrangement between customer and installer.

MOUNTING SPACE

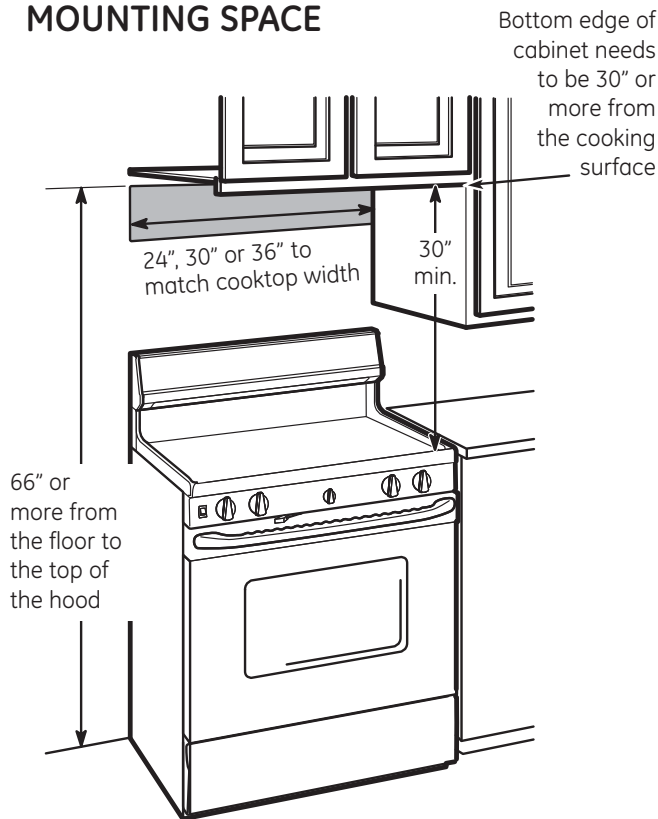

NOTES:

- Hood width may be greater than the width of the range or cooktop, but it may not be smaller.
- Ensure the range or cooktop is installed per manufacturer's installation instructions.
- If you are going to vent your range hood to the outside, see the "Ducting Requirements" section for exhaust duct preparation.

TOOLS YOU WILL NEED



PARTS INCLUDED

PART	QUANTITY
Grease Filter only (JV338)	1
Charcoal Filter only (JN327 and RN328)	1
Grease Filter and Charcoal Filter (JV24X, JV347, JV348 and JV367)	2
Mounting Screws (8 - 18" x 3/4" Phillips pan head)	4
Exhaust Adaptor (for 3 3/4" x 10" rect. venting)	1
Exhaust Adaptor Screw (8 - 18" x 3/8" Phillips pan head or hex head)	1

1 ft = 0.3 m; 1 in. = 2.5 cm

Installation Instructions

1 CHOOSE VENT OPTION

Determine the vent option that your installation will require and that is available for your model from the below choices.

IMPORTANT: If the hood is to be installed in a recirculating, non-vented, ductless manner, do not knock out any vent openings in the hood. Only an electrical access hole will be knocked out of the hood.

A Outside top exhaust (Vertical duct-3 $\frac{1}{4}$ "x 10" Rectangular)

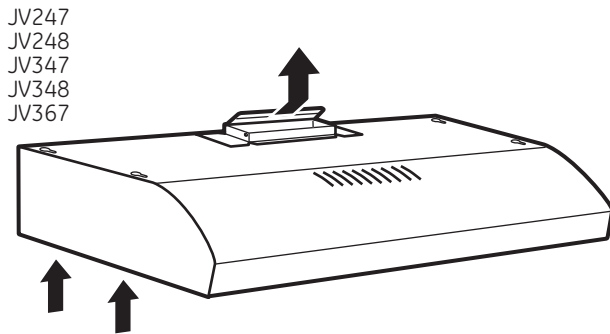
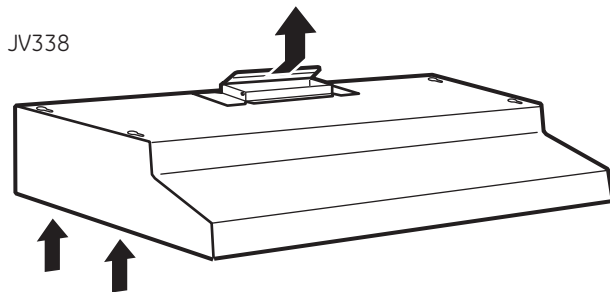

C Outside rear exhaust (Horizontal duct-3 $\frac{1}{4}$ "x 10" Rectangular)

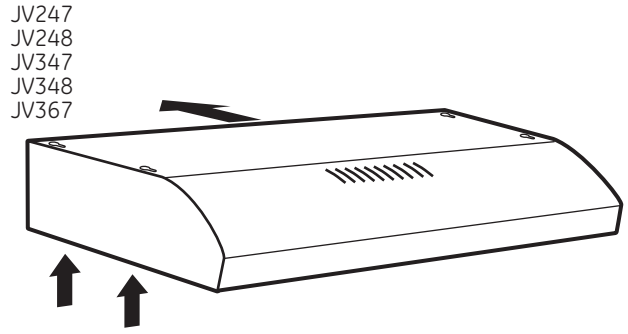
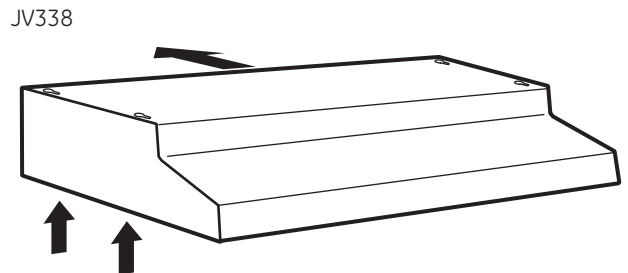

B Outside top exhaust (Vertical duct-7" Round)

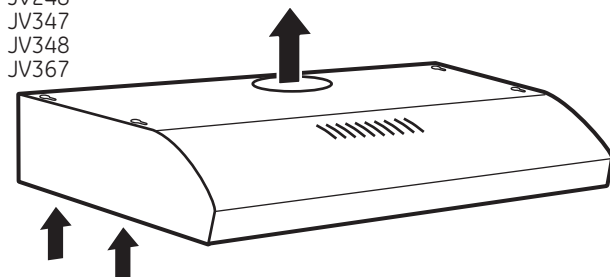
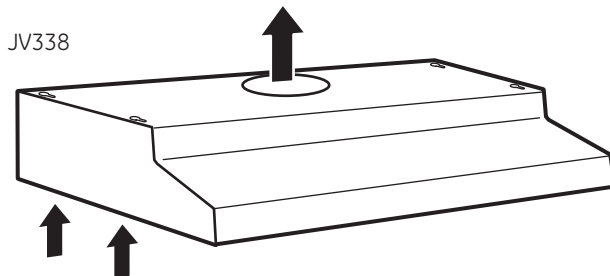

D Recirculating (non-vented/ductless)

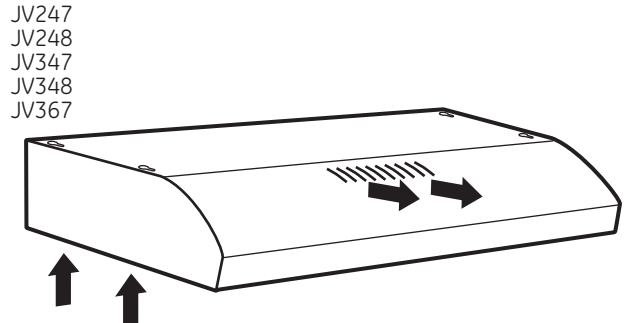
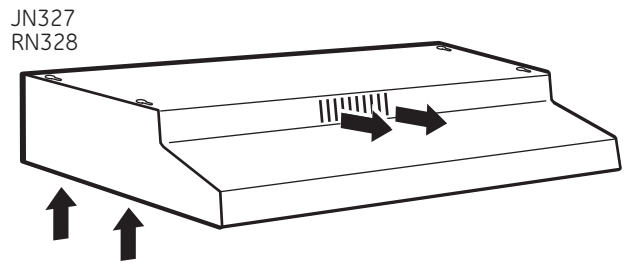

1 ft = 0.3 m; 1 in. = 2.5 cm

Installation Instructions

2 REMOVE EXHAUST ADAPTOR

If exhausting/venting using the $3\frac{1}{4}$ " x 10" rectangular duct—optional for JV247, JV248, JV338, JV347, JV348 and JV367 models only:

Remove the exhaust adaptor from the inside of the hood. Set it aside along with its mounting screws.

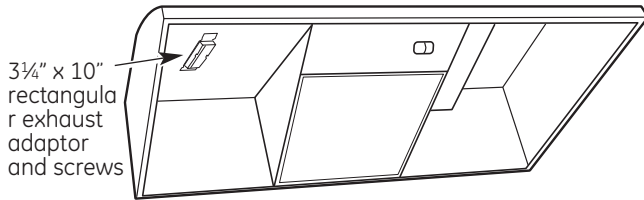

3 REMOVE FILTER

Remove the shipping tape holding the **metal grease filter** in place. Pull down on the center of the front edge of the filter. The filter will then slip out of the retaining tabs on the back.

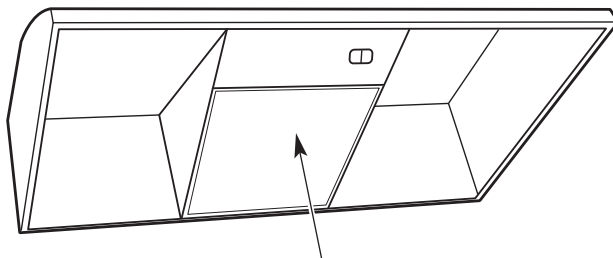

4 REVERSE THE BAFFLE FOR DUCTED INSTALLATIONS ONLY (JV247, JV248, JV347, JV348 and JV367 models)

If the hood is to be recirculated, skip to the next step. Remove the baffle from the top of the hood. Reinstall the baffle so the short side marked "VENTED" is visible. The long side of the baffle should be inside the hood.

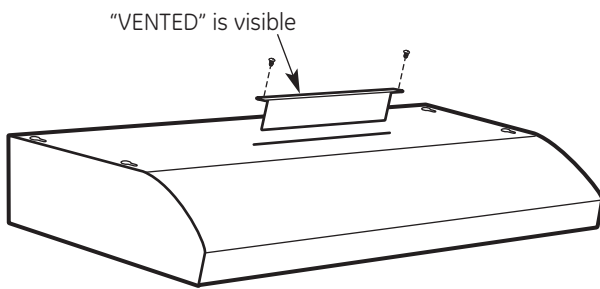

1 ft = 0.3 m; 1 in. = 2.5 cm

5 REMOVE WIRING COVER

Remove the **wiring cover** from inside the hood. Set the cover and its mounting screws aside.

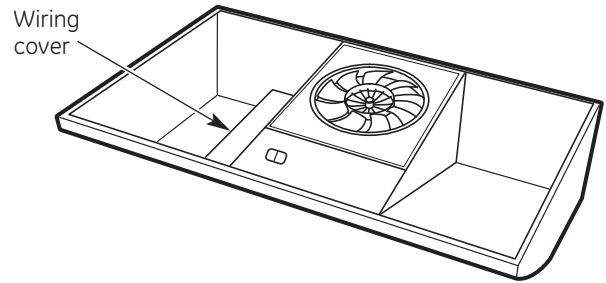

6 REMOVE WIRING KNOCKOUT

Remove either the top or the back wiring knockout as needed and install an approved **strain relief clamp**.

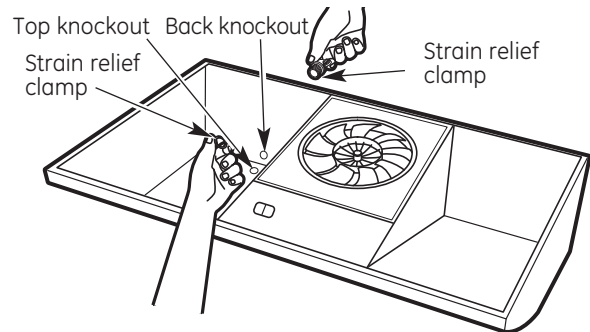

7 REMOVE DUCT KNOCKOUT

If **recirculating**, non-vented ductless (JN327 and RN328, and optional for JV247, JV248, JV347, JV348 and JV367 models only), **skip to Step 11 D and proceed**.

Using a flat-blade screwdriver, remove the appropriate **duct knockout** from the top or back of the hood.

$3\frac{1}{4}$ " x 10" Rectangular vertical discharge. Remove top rectangular duct knockout only.

7" Round vertical discharge. Remove circular duct knockout only.

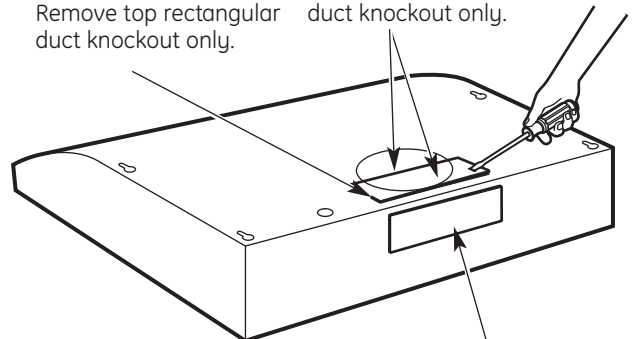

Installation Instructions

8 FOR 3¼" X 10" RECTANGULAR DUCTED DISCHARGE INSTALLATIONS ONLY:

Attach **exhaust adaptor/damper** over the appropriate knockout opening (for vertical or horizontal, depending on installation) with two exhaust adaptor screws. Make sure damper **pivot** is nearest to **top/back edge** of hood. Remove **tape** from damper flap.

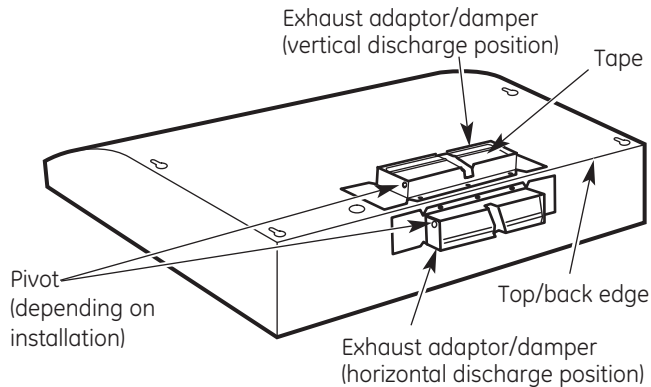

10 FOR RECESSED-BOTTOM CABINETS ONLY

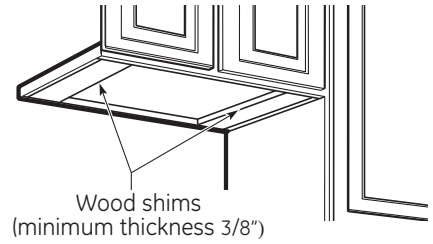

- If the cabinets have front, side or back trim, make 2 wood shims a minimum of 3/8" thick and cut to fit the width of the inner recessed cabinet bottom. Attach them to the cabinet bottom recess on both sides. See Step 11 for marking locations.

9 FOR 7" ROUND VERTICAL DUCTED DISCHARGE INSTALLATIONS ONLY:

Bend up the duct alignment ears in preparation for later attachment of the 7" duct.

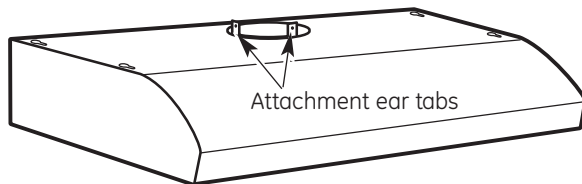

1 ft = 0.3 m; 1 in. = 2.5 cm

Installation Instructions

11 MARK HOLES

Select the vent option that your installation will require and proceed to that section:

A. Outside top exhaust (Vertical duct-3 1/4" x 10" Rectangular)

- Use the diagram or the hood as a template and mark the locations on the cabinet for ductwork, electrical wiring and keyhole screw slots.

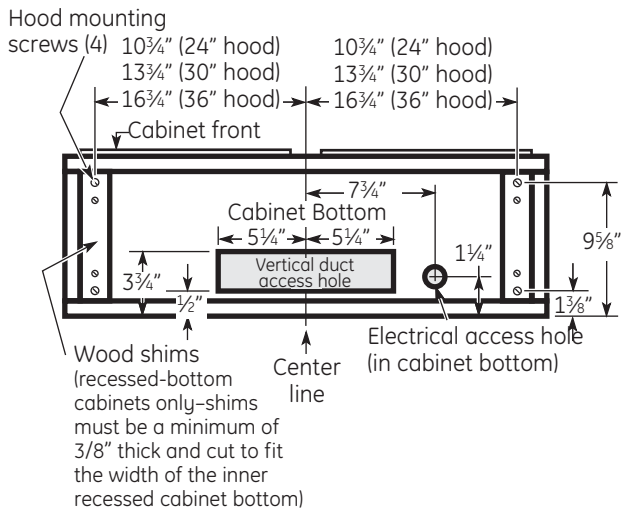

B. Outside top exhaust (Vertical duct-7" Round)

- Use the diagram or the hood as a template and mark the locations on the cabinet for ductwork, electrical wiring and keyhole screw slots.

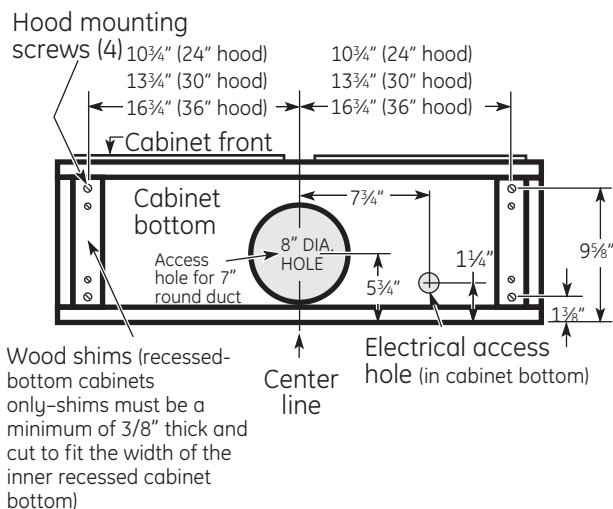

C. Outside rear exhaust (Horizontal duct-3 1/4" x 10" Rectangular)

- Use the diagram or the hood as a template and mark the locations on the cabinet for ductwork, electrical wiring and keyhole screw slots.

Wood shims

(recessed-bottom cabinets only—shims must be a minimum of 3/8" thick and cut to fit the width of the inner recessed cabinet bottom)

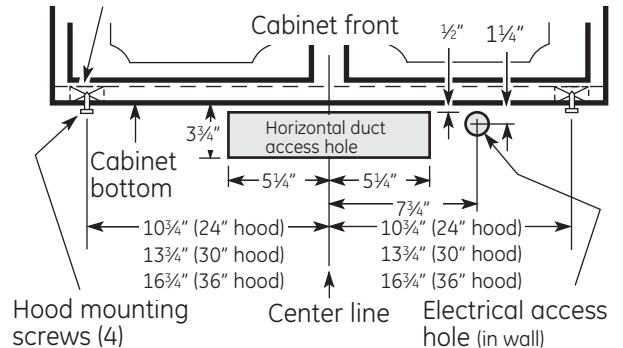

D. Recirculating (non-vented ductless—JN327 and RN328, and optional on JV247, JV248, JV347, JV348 and JV367 models only)

- Use the hood as a template and mark the locations on the cabinet for the electrical wiring and keyhole screw slots.
- Since the hood is to be recirculated (not to be vented outside), do not cut out any vent openings in the wall or cabinet bottom.

12 CUT HOLES

Cut holes at marked locations for duct and electrical wiring. For the vertical duct, cut out 3/4" extra toward the front of the cabinet so you can move the duct freely when installing the hood. It may also ease installation by cutting the hole 10 1/2" instead of 10".

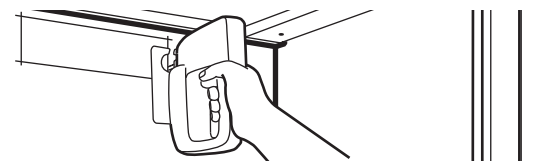

13 RUN WIRES

Run the electrical wires through the wall or cabinet according to National Electrical Code and applicable local codes.

NOTE: DO NOT turn the power on until installation is complete.

1 ft = 0.3 m; 1 in. = 2.5 cm

Installation Instructions

14 SCREW IN PART WAY

Drive a mounting screw (from the hardware packet) part way into each center of the narrow neck of the keyhole slots marked on the cabinet bottom.

15 OPTIONAL POWER CORD KIT JXHC1

An optional Power Cord Connection Kit, model JXHC1, is available at extra cost from your GE supplier for installation using a standard 3-prong, grounded wall outlet. Follow the Installation Instructions packed with the kit to connect the power cord to the range hood.

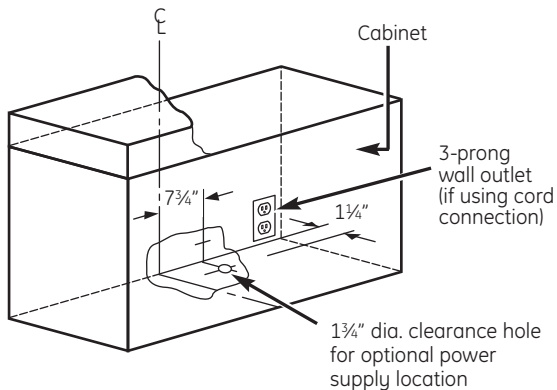

NOTE: If using optional Power Cord Kit JXHC1, feed the power cord through the hole in the top cabinet while raising the hood. Loop any excess length of cord and tie away with a suitable tape or tie.

16 FEED IN WIRES

Lift the hood into position and feed the house wiring through the wiring knockout.

17 SECURE HOOD

Slide the hood back against the wall. Tighten the mounting screws. Be sure the screw heads are in the narrow neck of the keyhole slot.

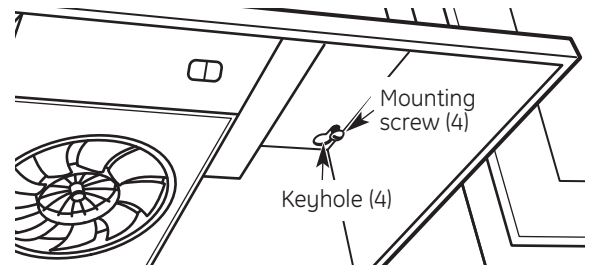

NOTE: DO NOT PUSH ON THE FAN BLADE. Pushing on the blade may cause it to interfere with other hood parts.

18 CONNECT DUCTWORK TO HOOD (Ducted installations only)

On 7" round installations, attach the 7" duct with sheet metal screws through the holes in the alignment ears.

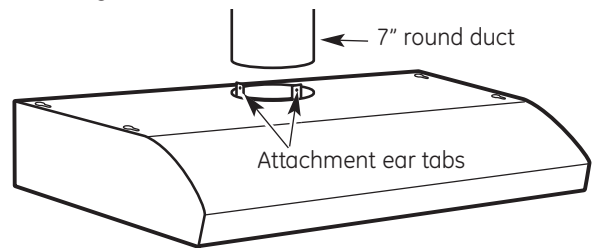

Use **duct tape** to make joints secure and airtight.

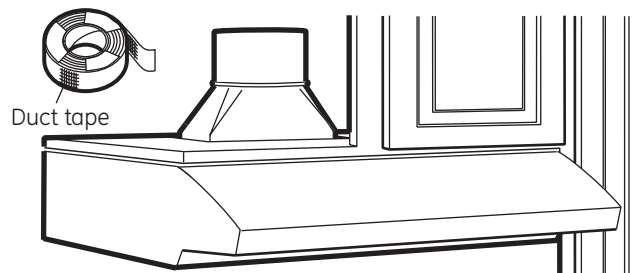

1 ft = 0.3 m; 1 in. = 2.5 cm

Installation Instructions

19 INSTALL LIGHT BULB

NOTE: A light bulb is not shipped with the hood. Obtain one locally. Purchase and install a type **A15** incandescent light bulb with an ordinary screw base, **not more than 60 Watts**, or a type **A17** or **T2** Compact Fluorescent (CFL) light bulb with an ordinary screw base, **not more than 13 Watts**. **NOTE:** Use **only** incandescent bulbs in models RN328, JN327 and JV338.

IMPORTANT: For installation, handling and disposal precautions, refer to the fluorescent bulb packaging literature.

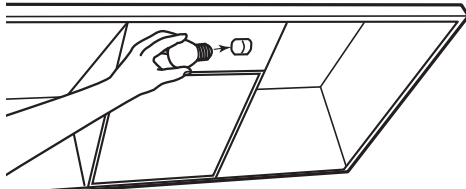

When using an energy saving bulb in your GE hood, make sure you use either:



GE Long Life Energy
Smart™ Spiral® T2
Product Code: 85383
Description:
FLE13HT2/2/SW/CD

or



GE Long Life Energy
Smart™ A17
Product Code: 47486
Description:
FLE11/2/A17XL/CD

Visit your local Mabe Parts Store.

20 FOLLOW ELECTRICAL CODE

Complete the electrical wiring according to National Electrical Code and local codes.

NOTE: This hood must be permanently grounded. Connect **house wiring** (120 VAC) to hood wiring.

21 CONNECT WIRING

Connect house black to hood black wire, house white to hood white wire and house ground under **green ground screw**. Securely tighten the strain relief clamp onto the house wiring.

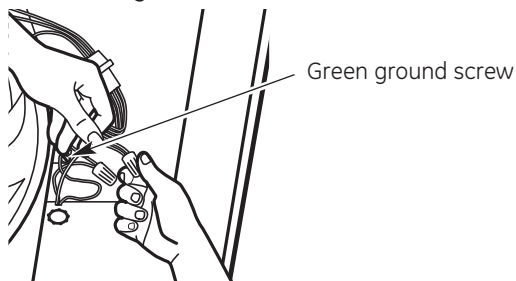

⚠ WARNING: IMPROPER CONNECTION OF ALUMINUM HOUSE WIRING TO THESE COPPER LEADS CAN RESULT IN A SERIOUS PROBLEM. USE ONLY CONNECTORS DESIGNED FOR JOINING COPPER TO ALUMINUM AND FOLLOW THE MANUFACTURER'S RECOMMENDED PROCEDURE CLOSELY.

22 REPLACE WIRING COVER

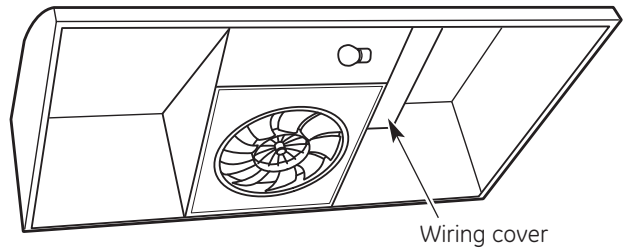

Wiring cover

23 REPLACE FILTER

Make sure fan blade turns freely and replace the filter. **NOTE:** Install the metal grease filter if ducted or the charcoal filter if recirculated.

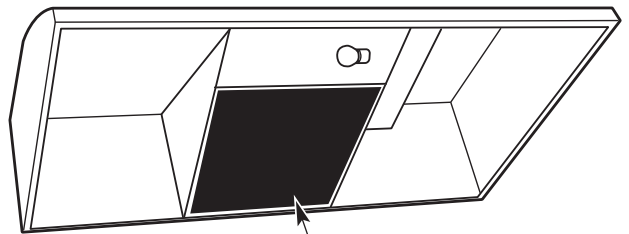

Metal grease filter or charcoal filter

The installation is complete. Turn on power at service panel, and test for proper operation.

TROUBLESHOOTING CHECKLIST

If the hood seems to be operating at high speed when the control is not set on high, or if ventilation seems inadequate, check the following:

- Knockouts not removed from hood.
- Damper blade not opening.
- Reduced airflow because the duct is too small or the duct length is too long.
- The duct is blocked.
- Undersized or restrictive wall or roof cap.

If the hood seems to make excessive noise:

- Fan may be hitting the filter. Turn off the fan and remove the filter. Bend the filter down slightly in the center (into a dome shape) to allow fan clearance. Reinstall and adjust as needed.

The fan does not work but the lights do:

- Switch power off at the service panel and lock the service disconnecting means to prevent power from being switched on accidentally. When the service disconnecting means cannot be locked, securely fasten a prominent warning device, such as a tag, to the service panel.
- Check the wiring connections. See the CONNECT WIRING section in these Installation Instructions.

Notes

Mabe Range Hood Warranty.



All warranty service provided by our Factory Service Centers, or an authorized Customer Care® technician. To schedule service, visit us on-line at GEAppliances.ca, or call 800.561.3344. Please have serial number and model number available when calling for service.

Staple your receipt here.
Proof of the original purchase date is needed to obtain service under the warranty.

For The Period Of: Mabe Will Replace:

One Year

From the date of the original purchase

Any part of the range hood which fails due to a defect in materials or workmanship. During this **limited one-year warranty**, Mabe will also provide, **free of charge**, all labor and in-home service to replace the defective part.

What Mabe Will Not Cover:

- Service trips to your home to teach you how to use the product.
- Improper installation, delivery or maintenance.
- Failure of the product if it is abused, misused, or used for other than the intended purpose or used commercially.
- Replacement of house fuses or resetting of circuit breakers.
- Damage to the product caused by accident, fire, floods or acts of God.
- Incidental or consequential damage caused by possible defects with this appliance.
- Damage caused after delivery.
- Product not accessible to provide required service.

EXCLUSION OF IMPLIED WARRANTIES—Your sole and exclusive remedy is product repair as provided in this Limited Warranty. Any implied warranties, including the implied warranties of merchantability or fitness for a particular purpose, are limited to one year or the shortest period allowed by law.

This warranty is extended to the original purchaser and any succeeding owner for products purchased for home use within Canada. If the product is located in an area where service by a Mabe Authorized Servicer is not available, you may be responsible for a trip charge or you may be required to bring the product to an Authorized Mabe Service Location for service.

Some provinces do not allow the exclusion or limitation of incidental or consequential damages. This warranty gives you specific legal rights, and you may also have other rights which vary from province to province. To know what your legal rights are, consult your local or provincial consumer affairs office or your province's Attorney General.

Warrantor: Mabe Canada Inc. Burlington, Ontario

Consumer Support.



GE Appliances Website

GEAppliances.ca

Have a question or need assistance with your appliance? Try the GE Appliances Website 24 hours a day, any day of the year! For greater convenience and faster service, you can now download Owner's Manuals, order parts or even schedule service on-line.

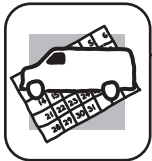

Schedule Service

GEAppliances.ca

Expert Mabe repair service is only one step away from your door. Get on-line and schedule your service at your convenience any day of the year! Or call 800.561.3344 during normal business hours.

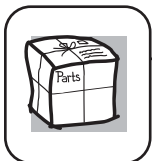

Parts and Accessories

GEAppliances.ca

Individuals qualified to service their own appliances can have parts or accessories sent directly to their homes (VISA and MasterCard are accepted). Order by phone at 800.661.1616 during normal business hours.

Instructions contained in this manual cover procedures to be performed by any user. Other servicing generally should be referred to qualified service personnel. Caution must be exercised, since improper servicing may cause unsafe operation.



Contact Us

GEAppliances.ca

If you are not satisfied with the service you receive from GE, contact us on our Website with all the details including your phone number, or write to:

General Manager, Customer Relations
Mabe Canada Inc.
Suite 310, 1 Factory Lane
Moncton, N.B. E1C 9M3



Register Your Appliance

GEAppliances.ca

Register your new appliance on-line—at your convenience! Timely product registration will allow for enhanced communication and prompt service under the terms of your warranty, should the need arise. You may also mail in the pre-printed registration card included in the packing material.