



Microwave Oven

Safety Instructions 2-5

Operating Instructions

Auto Features.....15
Microwave Terms22
Oven Features 6-8
Other Features.....18-22
Power Levels..... 9
Sensor Features.....16-18
Time Features.....10-14

Care and Cleaning23-25

Troubleshooting Tips26

Things That Are Normal26

Consumer Support

Consumer Support.....Back Cover
Product Registration..... 29
Warranty31

Owner's Manual

JVM6175

Write the model and serial numbers here:

Model # _____

Serial # _____

You can find them on a label inside the oven.

IMPORTANT SAFETY INSTRUCTIONS.

READ ALL INSTRUCTIONS BEFORE USING.

▲ WARNING!

To reduce risk of burns, electric shock, fire, personal injury or exposure to excessive microwave energy.

PRECAUTIONS TO AVOID POSSIBLE EXPOSURE TO EXCESSIVE MICROWAVE ENERGY

- (a) **Do Not Attempt** to operate this oven with the door open since open-door operation can result in harmful exposure to microwave energy. It is important not to defeat or tamper with the safety interlocks.
- (b) **Do Not Place** any object between the oven front face and the door or allow soil or cleaner residue to accumulate on sealing surfaces.
- (c) **Do Not Operate** the oven if it is damaged. It is particularly important that the oven door close properly and that there is no damage to the:
 - (1) door (bent),
 - (2) hinges and latches (broken or loosened),
 - (3) door seals and sealing surfaces.
- (d) **The Oven Should Not** be adjusted or repaired by anyone except properly qualified service personnel.

IMPORTANT SAFETY INSTRUCTIONS.

Use this appliance only for its intended purpose as described in this Owner's Manual.

When using electrical appliances basic safety precautions should be followed, including the following:

- Read and follow the specific precautions in the PRECAUTIONS TO AVOID POSSIBLE EXPOSURE TO EXCESSIVE MICROWAVE ENERGY section above.
- This appliance must be grounded. Connect only to a properly grounded outlet. See the *GROUNDING INSTRUCTIONS* section on page 5.
- Install or locate this appliance only in accordance with the provided installation instructions.
- This microwave oven is not approved or tested for marine use.
- Do not mount this appliance over a sink.
- Do not operate this appliance if it has a damaged power cord or plug, if it is not working properly, or if it has been damaged or dropped.
- Do not cover or block any openings on the appliance.
- Use this appliance only for its intended use as described in this manual. Do not use corrosive chemicals or vapors in this appliance. This microwave oven is specifically designed to heat, dry or cook food, and is not intended for laboratory or industrial use.
- Do not store this appliance outdoors. Do not use this product near water—for example, in a wet basement, near a swimming pool, near a sink or in similar locations.
- Do not let cord hang over edge of table or counter.
- Do not store anything directly on top of the appliance when it is in operation.
- Keep power cord away from heated surfaces.
- Do not immerse power cord or plug in water.
- To reduce the risk of fire in the oven cavity:
 - Do not overcook food. Carefully attend appliance when paper, plastic or other combustible materials are placed inside the oven while cooking.
 - Remove wire twist-ties and metal handles from paper or plastic containers before placing them in the oven.
 - Do not use the oven for storage purposes. Do not leave paper products, cooking utensils or food in the oven when not in use.
 - If materials inside the oven ignite, keep the oven door closed, turn the oven off and disconnect the power cord, or shut off power at the fuse or circuit breaker panel. If the door is opened, the fire may spread.
- See door surface cleaning instructions in the Care and cleaning of the microwave oven section of this manual. Do not use cleaners with ammonia or alcohol on the microwave oven. Ammonia and alcohol can damage the appearance of the microwave.
- Mabe Canada does not support any servicing of this microwave oven, except as described by the Consumer Support sections of this manual. Do not attempt to service the microwave oven yourself. If service is desired, this appliance should be serviced only by qualified service personnel. Contact the nearest authorized service facility for examination, repair or adjustment.
- As with any appliance, close supervision is necessary when used by children.

SAVE THESE INSTRUCTIONS

⚠ WARNING!

IMPORTANT SAFETY INSTRUCTIONS.

- Do not clean with metal scouring pads. Pieces can burn off the pad and touch electrical parts involving risk of electric shock.
- This microwave oven is cUL listed for installation over both gas (less than 60,000BTU) and electric ranges.
- This over-the-range oven is designed for use over ranges no wider than 36" (91.4 cm). It may be installed over both gas and electric cooking equipment. .

ARCING

If you see arcing, press the **Cancel/Off** pad and correct the problem.

Arcing is the microwave term for sparks in the oven. Arcing is caused by:

- Metal or foil touching the side of the oven.
- Foil not molded to food.
- Plates or dishes with metallic trim or glaze with a metallic sheen.
- Metal, such as twist-ties, poultry pins or gold-rimmed dishes, in the microwave.
- Recycled paper towels containing small metal pieces being used in the microwave.

FOODS

- Do not pop popcorn in your microwave oven unless in a special microwave popcorn accessory or unless you use popcorn labeled for use in microwave ovens.
- Some products such as whole eggs and sealed containers—for example, closed jars—are able to explode and should not be heated in this microwave oven. Such use of the microwave oven could result in injury.
- Do not boil eggs in a microwave oven. Pressure will build up inside egg yolk and will cause it to burst, possibly resulting in injury.
- Operating the microwave with no food inside for more than a minute or two may cause damage to the oven and could start a fire. It increases the heat around the magnetron and can shorten the life of the oven.
- Foods with unbroken outer "skin" such as potatoes, hot dogs, sausages, tomatoes, apples, chicken livers and other giblets and egg yolks should be pierced to allow steam to escape during cooking.
- Avoid heating baby food in glass jars, even with the lid off. Make sure all infant food is thoroughly cooked. Stir food to distribute the heat evenly. Be careful to prevent scalding when warming formula. The container may feel cooler than the formula really is. Always test the formula before feeding the baby.
- Don't defrost frozen beverages in narrow-necked bottles (especially carbonated beverages). Even if the container is opened, pressure can build up. This can cause the container to burst, possibly resulting in injury.
- **SUPERHEATED WATER**
Liquids, such as water, coffee or tea are able to be overheated beyond the boiling point without appearing to be boiling. Visible bubbling or boiling when the container is removed from the microwave oven is not always present. THIS COULD RESULT IN VERY HOT LIQUIDS SUDDENLY BOILING OVER WHEN THE CONTAINER IS DISTURBED OR A SPOON OR OTHER UTENSIL IS INSERTED INTO THE LIQUID.

To reduce the risk of injury to persons:

- Do not overheat the liquid.
- Stir the liquid both before and halfway through heating it.
- Do not use straight-sided container with narrow necks.
- After heating, allow the container to stand in the microwave oven for a short time before removing the container.
- Use extreme care when inserting a spoon or other utensil into the container.
- Hot foods and steam can cause burns. Be careful when opening any containers of hot food, including popcorn bags, cooking pouches and boxes. To prevent possible injury, direct steam away from hands and face.
- Do not overcook potatoes. They could dehydrate and catch fire, causing damage to your oven.
- Cook meat and poultry thoroughly—meat to at least an INTERNAL temperature of 160°F (71°C) and poultry to at least an INTERNAL temperature of 180°F (82°C). Cooking to these temperatures usually protects against foodborne illness.

SAVE THESE INSTRUCTIONS

IMPORTANT SAFETY INSTRUCTIONS.

READ ALL INSTRUCTIONS BEFORE USING.

▲ WARNING!

Make sure all cookware used in your microwave oven is suitable for microwaving. Most glass casseroles, cooking dishes, measuring cups, custard cups, pottery or china dinnerware which does not have metallic trim or glaze with a metallic sheen can be used. Some cookware is labeled “suitable for microwaving.”

- If you are not sure if a dish is microwave-safe, use this test: Place in the oven both the dish you are testing and a glass measuring cup filled with 1 cup (240 mL) of water—set the measuring cup either in or next to the dish. Microwave 30–45 seconds at high. If the dish heats, it should not be used for microwaving.

If the dish remains cool and only the water in the cup heats, then the dish is microwave-safe.
- If you use a meat thermometer while cooking, make sure it is safe for use in microwave ovens.
- Do not use recycled paper products. Recycled paper towels, napkins and waxed paper can contain metal flecks which may cause arcing or ignite. Paper products containing nylon or nylon filaments should be avoided, as they may also ignite.
- Some foam trays (like those that meat is packaged on) have a thin strip of metal embedded in the bottom. When microwaved, the metal can burn the floor of the oven or ignite a paper towel.
- Do not use the microwave to dry newspapers.
- Not all plastic wrap is suitable for use in microwave ovens. Check the package for proper use.
- Paper towels, waxed paper and plastic wrap can be used to cover dishes in order to retain moisture and prevent spattering. Be sure to vent plastic wrap so steam can escape.

- Cookware may become hot because of heat transferred from the heated food. Pot holders may be needed to handle the cookware.
- “Boilable” cooking pouches and tightly closed plastic bags should be slit, pierced or vented as directed by package. If they are not, plastic could burst during or immediately after cooking, possibly resulting in injury. Also, plastic storage containers should be at least partially uncovered because they form a tight seal. When cooking with containers tightly covered with plastic wrap, remove covering carefully and direct steam away from hands and face.
- Use foil only as directed in this guide. TV dinners may be microwaved in foil trays less than 3/4” (1.9 cm); remove the top foil cover and return the tray to the box. When using foil in the microwave oven, keep the foil at least 1” (2.5 cm) away from the sides of the oven.
- Plastic cookware—Plastic cookware designed for microwave cooking is very useful, but should be used carefully. Even microwave-safe plastic may not be as tolerant of overcooking conditions as are glass or ceramic materials and may soften or char if subjected to short periods of overcooking. In longer exposures to overcooking, the food and cookware could ignite.

Follow these guidelines:

1. Use microwave-safe plastics only and use them in strict compliance with the cookware manufacturer’s recommendations.
2. Do not microwave empty containers.
3. Do not permit children to use plastic cookware without complete supervision.

THE VENT FAN

The fan will operate automatically under certain conditions (see Automatic Fan feature). Take care to prevent the starting and spreading of accidental cooking fires while the vent fan is in use.

- Clean the underside of the microwave often. Do not allow grease to build up on the microwave or the fan filters.
- In the event of a grease fire on the surface units below the microwave oven, smother a flaming pan on the surface unit by covering the pan completely with a lid, a cookie sheet or a flat tray.
- Use care when cleaning the vent fan filters. Corrosive cleaning agents, such as lye-based oven cleaners, may damage the filters.
- When preparing flaming foods under the microwave, turn the fan on.
- Never leave surface units beneath your microwave oven unattended at high heat settings. Boilovers cause smoking and greasy spillovers that may ignite and spread if the microwave vent fan is operating. To minimize automatic fan operation, use adequate sized cookware and use high heat on surface units only when necessary.

SAVE THESE INSTRUCTIONS

GROUNDING INSTRUCTIONS

⚠ WARNING—Improper use of the grounding plug can result in a risk of electric shock.

This appliance must be grounded. In the event of an electrical short circuit, grounding reduces the risk of electric shock by providing an escape wire for the electric current.

This appliance is equipped with a power cord having a grounding wire with a grounding plug. The plug must be plugged into an outlet that is properly installed and grounded.

Consult a qualified electrician or service technician if the GROUNDING INSTRUCTIONS are not completely understood, or if doubt exists as to whether the appliance is properly grounded.

If the outlet is a standard 2-prong wall outlet, it is your personal responsibility and obligation to have it replaced with a properly grounded 3-prong wall outlet.

Do not under any circumstances cut or remove the third (ground) prong from the power cord.

We do not recommend using an extension cord with this appliance. If the power cord is too short, have a qualified electrician or service technician install an outlet near the appliance. (See EXTENSION CORDS section.)

For best operation, plug this appliance into its own electrical outlet to prevent flickering of lights, blowing of fuse or tripping of circuit breaker.

ADAPTER PLUGS

Usage situations where appliance's power cord will be disconnected infrequently.

Because of potential safety hazards under certain conditions, **we strongly recommend against the use of an adapter plug.** However, if you still elect to use an adapter, where local codes permit, a **TEMPORARY CONNECTION** may be made to a properly grounded wall receptacle by the use of a UL listed adapter which is available at most local hardware stores.

The larger slot in the adapter must be aligned with the larger slot in the wall receptacle to provide proper polarity in the connection of the power cord.

CAUTION: Attaching the adapter ground terminal to the wall receptacle cover screw does not ground the appliance unless the cover screw is metal, and not insulated, and the wall receptacle is grounded through the house wiring.

You should have the circuit checked by a qualified electrician to make sure the receptacle is properly grounded.

When disconnecting the power cord from the adapter, always hold the adapter with one hand. If this is not done, the adapter ground terminal is very likely to break with repeated use. Should this happen, **DO NOT USE** the appliance until a proper ground has again been established.

Usage situations where appliance's power cord will be disconnected frequently.

Do not use an adapter plug in these situations because frequent disconnection of the power cord places undue strain on the adapter and leads to eventual failure of the adapter ground terminal. You should have the 2-prong wall receptacle replaced with a 3-prong (grounding) receptacle by a qualified electrician before using the appliance.

PACEMAKERS

Most pacemakers are shielded from interference from electronic products, including microwaves. However, patients with pacemakers may wish to consult their physicians if they have concerns.

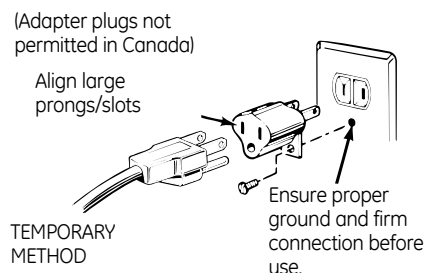

READ AND FOLLOW THIS SAFETY INFORMATION CAREFULLY.

SAVE THESE INSTRUCTIONS

About the features of your microwave oven.

Throughout this manual, features and appearance may vary from your model.

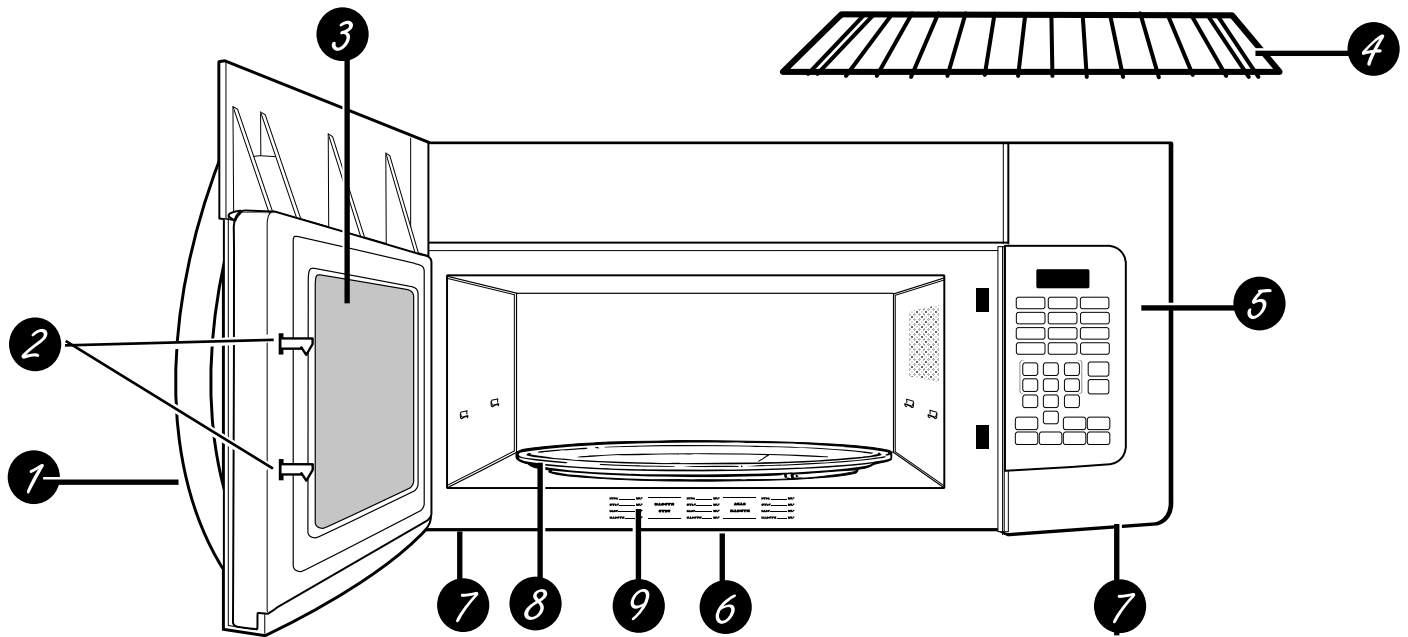

Features of the Oven

- 1 Door Handle.** Pull to open the door. The door must be securely latched for the microwave to operate.
- 2 Door Latches.**
- 3 Window with Metal Shield.** Screen allows cooking to be viewed while keeping microwaves confined in the oven.
- 4 Shelf** (some models). Lets you microwave several foods at once. Food microwaves best when placed directly on the oven floor or turntable.
- 5 Touch Control Panel.** You **must** set the clock and calendar before using the "Auto Night Light".

6 Cooktop Light.

7 Grease Filter.

8 Removable Turntable.

Turntable and support **must** be in place when using the oven. The turntable may be removed for cleaning.

9 Rating Plate.

NOTE: Oven vent(s) and oven light are located on the inside walls of the microwave oven.

Optional Accessories

Filler Panel Kits
JX48WH - White
JX48BL - Black

When replacing a 36" (91.4 cm) range hood, filler panel kits fill in the additional width to provide a custom built-in appearance.

For installation between cabinets only; not for end-of cabinet installation. Each kit contains two 3" (7.6 cm) wide filler panels. Two kits are needed for a 36" 91.4 cm) opening.

Recirculating Charcoal Filter Kit
JX81J (sales number)
WB02X1124 (service number)

Filter kits are used when the microwave oven cannot be vented to the outside.

Available at extra cost from your GE supplier, or see the GE Service numbers.

JX81J (sales number)
WB02X1124 (service number)

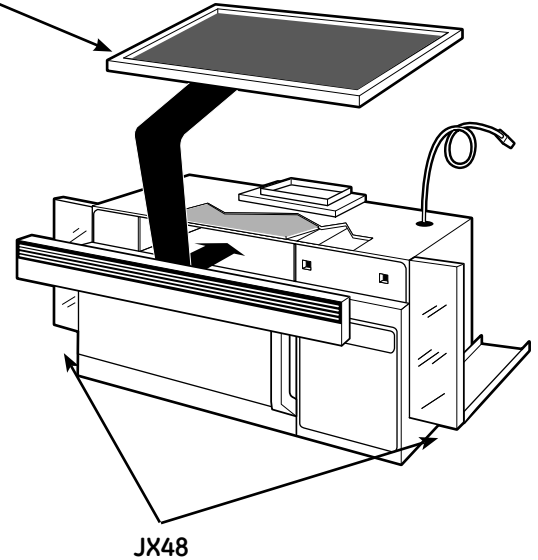

About the features of your microwave oven.

You can microwave by time or with the convenience features. Not all features on all models.

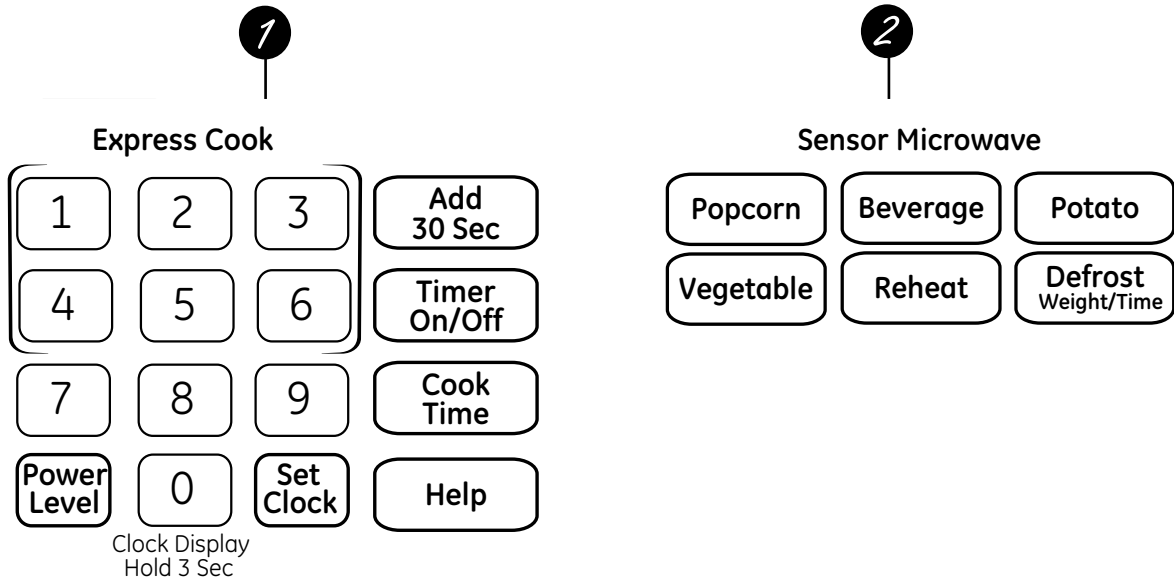

Cooking Controls

Check the Convenience Guide before you begin.

1 Time Features	
Press	Enter
Cook Time	Amount of cooking time
Defrost Weight/Time Press twice	Amount of defrosting time
Express Cook Press number pads (1-6)	Starts Immediately!
Add 30 Sec	Starts Immediately!
Power Level	Power level 1 to 10

2 Sensor Features		
Press	Enter	Options
Popcorn	Starts immediately!	more/less time
Beverage	Starts immediately!	
Reheat	Starts immediately!	more/less time
Potato	Starts Immediately!	more/less time
Vegetables Press once (fresh vegetables) Press twice (frozen vegetables) Press three times (canned vegetables)	Starts Immediately!	more/less time
Defrost Weight/Time Press once	Enter food weight	

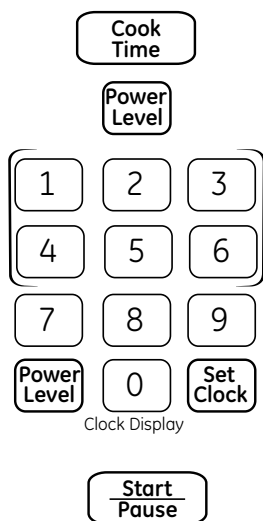

Changing the Power Level

The power level may be entered or changed immediately after entering the feature time for **Cook Time**, **Time Defrost**, **Add 30 Sec** or **Express Cook**. The power level may also be changed during the time countdown.

1. Press **Cook Time**.
 2. Enter cooking or defrosting time
 3. Press **Power Level**.
 4. Select desired power level **1-10**.
3. Press **Start/Pause**. Pressing **Start/Pause** is not necessary for **Express Cook** buttons.

Variable power levels add flexibility to microwave cooking. The power levels on the microwave oven can be compared to the surface units on a range. Each power level gives you microwave energy a certain percent of the time. **Power level 7** is microwave energy 70% of the time. **Power level 3** is energy 30% of the time. Most cooking will be done on HI which gives you 100% power.

Power Level 10 will cook faster but food may need more frequent stirring, rotating or turning over. A lower setting will cook more evenly and need less stirring or rotating of the food.

Some foods may have better flavor, texture or appearance if one of the lower settings is used. Use a lower power level when cooking foods that have a tendency to boil over, such as scalloped potatoes.

Rest periods (when the microwave energy cycles off) give time for the food to "equalize" or transfer heat to the inside of the food. An example of this is shown with **power level 3**—the defrost cycle. If microwave energy did not cycle off, the outside of the food would cook before the inside was defrosted.

Here are some examples of uses for various power levels:

Power Level 10: Fish, bacon, vegetables, boiling liquids.

Power Level 7: Gentle cooking of meat and poultry; baking casseroles and reheating.

Power Level 5: Slow cooking and tenderizing for stews and less tender cuts of meat.

Power Level 2 or 3: Defrosting; simmering; delicate sauces.

Power Level 1: Keeping food warm; softening butter.

About the time features.

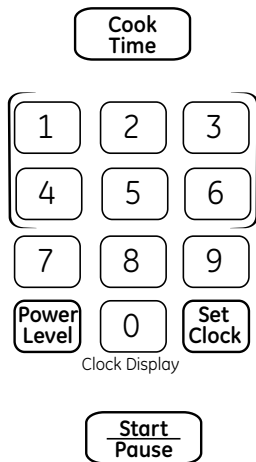

Cook Time I

Allows you to microwave for any time up to 99 minutes and 99 seconds.

Power level 10 (high) is automatically set, but you may change it for more flexibility.

1. Press **Cook Time**.
2. Enter cooking time.
3. Change power level if you don't want full power. (Press **Power Level**. Select a desired power level 1–10.)
4. Press **Start/Pause**.

You may open the door during Cook Time to check the food. Close the door and press **Start/Pause** to resume cooking.

Cook Time II

Lets you change power levels automatically during cooking. Here's how to do it:

1. Press **Cook Time**.
2. Enter the first cook time.
3. Change the power level if you don't want full power. (Press **Power Level**. Select a desired power level 1–10.)
4. Press **Cook Time** again.
5. Enter the second cook time.
6. Change the power level if you don't want full power. (Press **Power Level**. Select a desired power level 1–10.)
7. Press **Start/Pause**.

At the end of Cook Time I, Cook Time II counts down.

Cooking Guide for Cook Time

NOTE: Use power level 10 (High) unless otherwise noted.

Vegetable	Amount	Time	Comments
Asparagus (fresh spears)	1 lb. (454 g)	6 to 9 min., Med-High (7)	In 1½-qt. (1½ l) oblong glass baking dish, place 1/4 cup water. Rotate dish after half of time.
(frozen spears)	10-oz. (283 g) package	5 to 7 min.	In 1-qt. (1 l) casserole.
Beans (fresh green)	1 lb. (454 g) cut in half	9 to 11 min.	In 1½-qt. (1½ l) casserole, place 1/2 cup (120 mL) water.
(frozen green)	10-oz. (283 g) package	6 to 8 min.	In 1-qt. (1 l) casserole, place 2 tablespoons water.
(frozen lima)	10-oz. (283 g) package	6 to 8 min.	In 1-qt. (1 l) casserole, place 1/4 cup (60 mL) water.
Beets (fresh, whole)	1 bunch	17 to 21 min.	In 2-qt. (2 l) casserole, place 1/2 cup (120 mL) water.
Broccoli (fresh cut)	1 bunch (1¼ to 1½ lbs.)	7 to 10 min.	In 2-qt. (2 l) casserole, place 1/2 cup (120 mL) water.
(fresh spears)	1 bunch (1¼ to 1½ lbs.)	9 to 13 min.	In 2-qt. (2 l) oblong glass baking dish, place 1/4 cup (60 mL) water. Rotate dish after half of time.
(frozen, chopped)	10-oz. (283 g) package	5 to 7 min.	In 1-qt. (1 l) casserole.
(frozen spears)	10-oz. (283 g) package	5 to 7 min.	In 1-qt. (1 l) casserole, place 3 tablespoons water.
Cabbage (fresh)	1 medium head	8 to 11 min.	In 1½- or 2-qt. (1½ or 2 l) casserole, place 1/4 cup (60 mL) water.
(wedges)	(about 2 lbs./907 g)	7 to 10 min.	In 2- or 3-qt. (2 or 3 l) casserole, place 1/4 cup (60 mL) water.
Carrots (fresh, sliced)	1 lb. (454 g)	7 to 9 min.	In 1½-qt. (1½ l) (casserole, place 1/4 cup (60 mL) water.
(frozen)	10-oz. (283 g) package	5 to 7 min.	In 1-qt. (1 l) casserole, place 2 tablespoons water.
Cauliflower (flowerets)	1 medium head	9 to 14 min.	In 2-qt. (2 l) casserole, place 1/2 cup (120 mL) water.
(fresh, whole)	1 medium head	10 to 17 min.	In 2-qt. (2 l) casserole, place 1/2 cup (120 mL) water.
(frozen)	10-oz. (283 g) package	5 to 7 min.	In 1-qt. (1 l) casserole, place 2 tablespoons water.
Corn (frozen kernel)	10-oz. (283 g) package	5 to 7 min.	In 1-qt. (1 l) casserole, place 2 tablespoons water.
Corn on the cob (fresh)	1 to 5 ears	3 to 4 min. per ear	In 2-qt. (2 l) oblong glass baking dish, place corn. If corn is in husk, use no water; if corn has been husked, add 1/4 cup (60 mL) water. Rearrange after half of time. Place in 2-qt. (2 l) oblong glass baking dish. Cover with vented plastic wrap. Rearrange after half of time.
(frozen)	1 ear 2 to 6 ears	5 to 6 min. 3 to 4 min. per ear	
Mixed vegetables (frozen)	10-oz. (283 g) package	5 to 7 min.	In 1-qt. (1 l) casserole, place 3 tablespoons water.
Peas (fresh, shelled)	2 lbs. (907 g) unshelled	9 to 12 min.	In 1-qt. (1 l) casserole, place 1/4 cup (60 mL) water.
(frozen)	10-oz. (283 g) package	5 to 7 min.	In 1-qt. (1 l) casserole, place 2 tablespoons water.
Potatoes (fresh, cubed, white)	4 potatoes (6 to 8 oz./170 to 227 g each)	9 to 12 min.	Peel and cut into 1 inch cubes. Place in 2-qt. (2 l) casserole with 1/2 cup (120 mL) water. Stir after half of time.
(fresh, whole, sweet or white)	1 (6 to 8 oz./170 to 227 g)	3 to 4 min.	Pierce with cooking fork. Place in the oven, 1 inch (2.5 cm) apart, in circular arrangement. Let stand 5 minutes.
Spinach (fresh)	10 to 16 oz. (283 to 454 g)	5 to 7 min.	In 2-qt. (2 l) casserole, place washed spinach.
(frozen, chopped and leaf)	10-oz. (283 g) package	5 to 7 min.	In 1-qt. (1 l) casserole, place 3 tablespoons water.
Squash (fresh, summer and yellow)	1 lb. (454 g) sliced	5 to 7 min.	In 1½-qt. (1½ l) casserole, place 1/4 cup (60 mL) water.
(winter, acorn or butternut)	1 to 2 squash (about 1 lb./454 g each)	8 to 11 min.	Cut in half and remove fibrous membranes. In 2-qt. (2 l) oblong glass baking dish, place squash cut-side-down. Turn cut-side-up after 4 minutes.

About the time features.

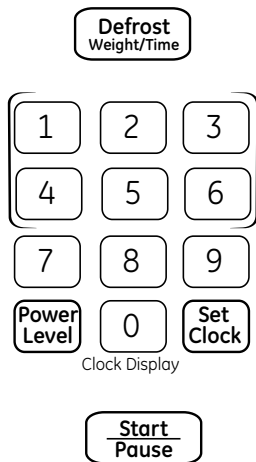

Time Defrost allows you to defrost for a selected length of time. See the Defrosting Guide for suggested times. (Weight Defrost is explained in the Auto Feature section.)

1. Press **Defrost Weight/Time** twice.
2. Enter defrosting time.
3. Press **Start/Pause**.
4. Turn food over when the oven signal.
5. Press **Start/Pause**.

When the oven signals, turn food over and break apart or rearrange pieces for more even defrosting. Shield any warm areas with small pieces of foil. The oven will continue to defrost if you don't open the door and turn the food.

Power level is automatically set at 3, but can be changed. You can defrost small items quickly by raising the power level after entering the time. Power level 7 cuts the total defrosting time in about half; power level 10 cuts the total time to approximately 1/3. However, food will need more frequent attention than usual.

A dull thumping noise may be heard during defrosting. This is normal when oven is not operating at High power.

Defrosting Tips

- Foods frozen in paper or plastic can be defrosted in the package. Closed packages should be slit, pierced or vented **AFTER** food has partially defrosted. Plastic storage containers should be partially uncovered.
- Family-size, prepackaged frozen dinners can be defrosted and microwaved. If the food is in a foil container, transfer it to a microwave-safe dish.
- For more even defrosting of larger foods, such as roasts, use Defrost Weight. Be sure large meats are completely defrosted before cooking.
- Foods that spoil easily should not be allowed to sit out for more than one hour after defrosting. Room temperature promotes the growth of harmful bacteria.
- When defrosted, food should be cool but softened in all areas. If still slightly icy, return to the microwave very briefly, or let it stand a few minutes counts down.

Defrosting Guide

Food	Time	Comments
Breads, Cakes Bread, buns or rolls (1 piece) Sweet rolls (approx. 12 oz./340 g)	1 min. 3 to 5 min.	Rearrange after half of time.
Fish and Seafood Fillets, frozen (1 lb./454 g) Shellfish, small pieces (1 lb./454 g)	6 to 8 min. 5 to 7 min.	Place block in casserole. Turn over and break up after first half of time.
Fruit Plastic pouch—1 or 2 (10-oz. package/283 g)	3 to 6 min.	
Meat Bacon (1 lb./454 g) Franks (1 lb./454 g) Ground meat (1 lb./454 g) Roast: beef, lamb, veal, pork Steaks, chops and cutlets	2 to 5 min. 2 to 5 min. 5 to 7 min. 12 to 16 min. per lb. (454 g) 5 to 7 min. per lb. (454 g)	Place unopened package in oven. Let stand 5 minutes after defrosting. Place unopened package in oven. Microwave just until franks can be separated. Let stand 5 minutes, if necessary, to complete defrosting. Turn meat over after first half of time. Use power level Warm (1). Place unwrapped meat in cooking dish. Turn over after first half of time and shield warm areas with foil. After second half of time, separate pieces with table knife. Let stand to complete defrosting.
Poultry Chicken, broiler-fryer, cut up (2½ to 3 lbs./1.1 to 1.4 kg) Chicken, whole (2½ to 3 lbs./1.1 to 1.4 kg) Cornish hen Turkey breast (4 to 6 lbs./1.8 to 2.7 kg)	15 to 19 min. 17 to 21 min. 7 to 13 min. per lb. (454 g) 5 to 9 min. per lb. (454 g)	Place wrapped chicken in dish. Unwrap and turn over after first half of time. After second half of time, separate pieces and place in cooking dish. Microwave 2 to 4 minutes more, if necessary. Let stand a few minutes to finish defrosting. Place wrapped chicken in dish. After first half of time, unwrap and turn chicken over. Shield warm areas with foil. To complete defrosting, run cool water in cavity until giblets can be removed. Place unwrapped hen in oven breast-side-up. Turn over after first half of time. Run cool water in cavity until giblets can be removed. Place unwrapped breast in microwave-safe dish breast-side-down. After first half of time, turn breast-side-up and shield warm areas with foil. Defrost for second half of time. Let stand 1 to 2 hours in refrigerator to complete defrosting.

About the time features.

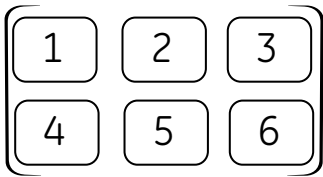

Express Cook

This is a quick way to set cooking time for 1–6 minutes.

Press one of the **Express Cook** pads (from 1 to 6) for 1 to 6 minutes of cooking at **power level 10**. For example, press the **2** pad for 2 minutes of cooking time.

The power level can be changed as time is counting down. Press **POWER LEVEL** and enter 1–10.



Add 30 Sec

You can use this feature two ways:

- It will add 30 seconds to the time counting down each time the pad is pressed.
- It can be used as a quick way to set 30 seconds of cooking time.

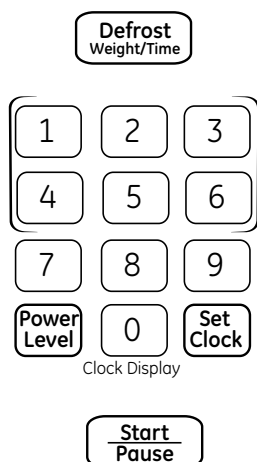

Weight Defrost

Weight defrost automatically sets the defrosting times and power levels to give even defrosting results for meats, poultry and fish weighing up to six pounds.

1. Press **Defrost Weight/Time** once.
2. Using the conversion guide, enter food weight. For example, press pads 1 and 2 for 1.2 pounds (544 g) (1 pound, 3 ounces).
3. Press **Start/Pause**.

(Time Defrost is explained in the Time Features section.)

- Remove meat from package and place on microwave-safe dish.
- When the oven signals, turn the food over. Remove defrosted meat or shield warm areas with small pieces of foil.
- After defrosting, most meats need to stand 5 minutes to complete defrosting. Large roasts should stand for about 30 minutes.

Conversion Guide

If the weight of food is stated in pounds and ounces, the ounces must be converted to tenths (.1) of a pound.	
Ounces	Pounds
1-2 (28-56 g)	.1
3 (85 g)	.2
4-5 (113-141 g)	.3
6-7 (170-198 g)	.4
8 (227 g)	.5
9-10 (255-283 g)	.6
11 (312 g)	.7
12-13 (340-368 g)	.8
14-15 (397-425 g)	.9

About the sensor features.

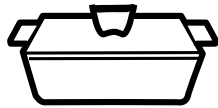

Covered



Vented



Dry off dishes so they don't mislead the sensor.

The Sensor Features detect the increasing humidity released during cooking. The oven automatically adjusts the cooking time to various types and amounts of food.

Do not use the Sensor Features twice in succession on the same food portion—it may result in severely overcooked or burnt food. Be sure to let the oven cool down for 5-10 minutes before starting the next sensor cook.

If food is undercooked after the countdown, use **Cook Time** for additional cooking time.

- The proper containers and covers are essential for best sensor cooking.
- **Always use microwave-safe containers and cover them with lids or vented plastic wrap. Never use tight-sealing plastic covers—** they can prevent steam from escaping and cause food to overcook.
- **Be sure the outside of the cooking container and the inside of the microwave oven are dry** before placing food in the oven. Beads of moisture turning into steam can mislead the sensor.

Popcorn

1

(less time)

9

(more time)

To use the Popcorn feature:

1. Follow package instructions, using **Cook Time** if the package is less than 3.0 oz. (85 g) or larger than 3.5 oz. (100 g). Place the package of popcorn in the center of the microwave.
2. Press **POPCORN**. The oven starts immediately.

If you open the door while **"Pop"** is displayed, **"Err"** will appear. Close the door, press **CancelOff** and begin again.

If food is undercooked after the countdown use **Cook Time** for additional cooking time.

How to Adjust the Popcorn Program to Provide a Shorter or Longer Cook Time

If you find that the brand of popcorn you use underpops or overcooks consistently, you can add or subtract 10% to the automatic popping time.

To add time:

After pressing **POPCORN**, press **9** immediately after the oven starts for an extra 10% of the automatic popping time.

To subtract time:

After pressing **POPCORN**, press **1** immediately after the oven starts for 10% less of the automatic popping time.

NOTE: Do not use this feature twice in succession on the same food portion—it may result in severely overcooked or burnt food.

Beverage

NOTE: Do not use this feature twice in succession on the same food portion—it may result in severely overcooked or burnt food.

To use the Beverage feature:

Press **Beverage** to heat a cup of coffee or other beverage.

Drinks heated with the Beverage feature may be very hot. Remove the container with care.

If food is undercooked after the countdown, use **Cook Time** for additional cooking time.

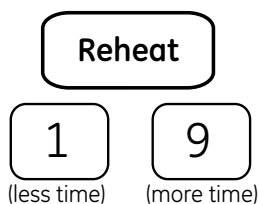

How to Change the Automatic Settings

To reduce time by 10%:
Press **1** after the feature pad.

To add 10% to cooking time:
Press **9** after the feature pad.

NOTE: Do not use the metal shelf when using the Reheat feature.

NOTE: Do not use this feature twice in succession on the same food portion—it may result in severely overcooked or burnt food.

To use the Reheat feature:

The Reheat feature reheats single servings of previously cooked foods or a plate of leftovers.

1. Place covered food in the oven. Press **Reheat**. The oven starts immediately.
2. The oven signals when steam is sensed and the time remaining begins counting down.

Do not open the oven door until time is counting down. If the door is opened, close it and press **Start/Pause** immediately.

After removing food from the oven, stir, if possible, to even out the temperature. If the food is not hot enough, use Cook Time to reheat for more time. Reheated foods may have wide variations in temperature. Some areas may be extremely hot.

If food is not hot enough after the countdown, use Cook Time for additional reheating time.

Some Foods Not Recommended For Use With Reheat:

It is best to use Cook Time for these foods:

- Bread products.
- Foods that must be reheated uncovered.
- Foods that need to be stirred or rotated.
- Foods calling for a dry look or crisp surface after reheating.

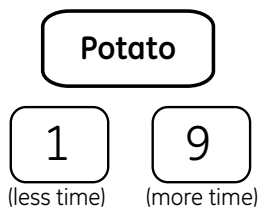

How to Change the Automatic Settings

To reduce time by 10%:
Press **1** after the feature pad.

To add 10% to cooking time:
Press **9** after the feature pad.

NOTE: Do not use the metal shelf when using the Reheat feature.

NOTE: Do not use this feature twice in succession on the same food portion—it may result in severely overcooked or burnt food.

Potato

1. Pierce potato skin with fork and place potato in the oven.
2. Press Potato. the oven starts immediately.
3. The oven signals when steam is sensed and time remaining is counting down. Turn or stir the food if necessary.

Do not open the oven door until time is counting down. If the door is opened, close it and press Start/Pause immediately.

If food is undercooked after the countdown, use **Cook Time** for additional cooking time.

About the sensor features.

Vegetable

1

(less time)

9

(more time)

How to Change the Automatic Settings

To reduce time by 10%:

Press **1** after the feature pad.

To add 10% to cooking time:

Press **9** after the feature pad.

NOTE: Do not use the metal shelf when using the Reheat feature.

NOTE: Do not use this feature twice in succession on the same food portion—it may result in severely overcooked or burnt food.

Vegetable

1. Place covered food in the oven. Press **Vegetable**.
2. Press **Start/Pause**. The oven signals when the steam is sensed and the time remaining begins counting down. Turn or stir the food if necessary.

If food is undercooked after the countdown, use **Cook Time** for additional cooking time.

Do not open the oven door until time is counting down. If the door is opened, close it and press Start/Pause immediately.

Food Type	Amount	Comment
Fresh Vegetables	4-16 Ounces (113-454 g)	Add 1/4 cup water per serving. Cover with lid or vented plastic wrap.
Frozen Vegetables	4-16 Ounces (113-454 g)	Follow package instructions for adding water. Cover with lid or vented plastic wrap.
Canned Vegetables	4-16 Ounces (113-454 g)	Cover with lid or vented plastic wrap.

About other features.

Cooking Complete Reminder

To remind you that you have food in the oven, the oven will display "Food is Ready" and beep once a minute until you either open the oven door or press **Cancel/Off**.

Help

Help

The Help pad displays feature information and helpful hints. Press **Help** then select a feature pad.

AM/PM

Scroll Speed
Hold 3 Sec

Scroll Speed

The scroll speed of the display can be changed. Press and hold the AM/PM pad about 3 seconds to bring up the display. Select 1-5 for slow to fast scroll speed.

0

Clock Display
Hold 3 Sec

Display On/Off

To turn the clock display on or off, press and hold **0** for about 3 seconds. The **Display On/Off** feature cannot be used while a cooking feature is in use.

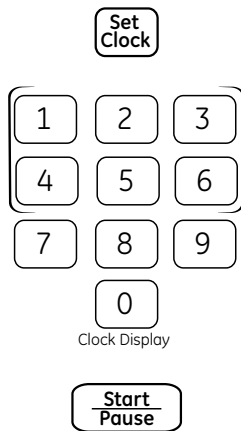

Set Clock

Press to enter the time of day or to check the time of day while microwaving.

1. Press **Set Clock**.
2. Enter time of day.
2. Select **AM/PM**.
3. Press **Start** or **Set Clock**.

To check the time of day while microwaving, press **Set Clock**.



Start/Pause

In addition to starting many functions, Start/Pause allows you to stop cooking without opening the door or clearing the display. Press **Start/Pause** again to restart the oven.



Child Lock-Out

You may lock the control panel to prevent the microwave from being accidentally started or used by children.

To lock or unlock the controls, press and hold **Cancel/Off** for about three seconds. When the control panel is locked, **LOCKED** will appear in the display.

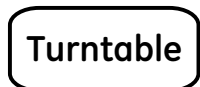

Turntable

For best cooking results, leave the turntable on. It can be turned off for large dishes. Press **TURNTABLE** to turn the turntable on or off.

Sometimes the turntable can become too hot to touch. Be careful touching the turntable during and after cooking.



Timer On/Off

Timer On/Off operates as a minute timer and can be used at any time, even when the oven is operating.

1. Press **TIMER ON/OFF**.
2. Enter time you want to count down.
3. Press **TIMER ON/OFF** to start.

When time is up, the oven will signal. To turn off the timer signal, press **TIMER ON/OFF**.

NOTE: *The timer indicator will be lit while the timer is operating.*



Vent Fan

The vent fan removes steam and other vapors from surface cooking.

Press Vent Fan once for high fan speed, twice for low fan speed or a third time to turn the fan off.

Automatic Fan

An automatic fan feature protects the microwave from too much heat rising from the cooktop below it. It automatically turns on at low speed if it senses too much heat.

If you have turned the fan on you may find that you cannot turn it off. The fan will automatically turn off when the internal parts are cool. It may stay on for 30 minutes or more after the cooktop and microwave controls are turned off.

About other features.

Surface Light

Surface Light

Press to turn the surface light on or off.

On some models, there is a night light option.

Press **Surface Light** once for bright light, twice for the night light or three times to turn the light off.

Sound

Sound

The beeper sound level can be adjusted. Press **Sound**. Choose 0-3 for mute to loud.

Auto Night Light

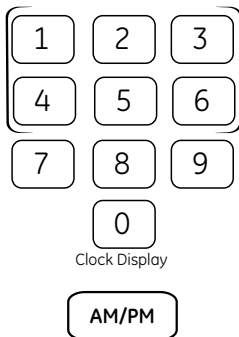

Auto Night Light

You can set the night light to turn on and off automatically at any time you want.

1. Press **Auto Night Light**.
2. Enter time you want the light to turn on. Select **AM/PM**.
3. Press **Auto Night Light** again and enter the time you want the light to turn off. Select **AM/PM**.
4. Press **Auto Night Light**.

Night will stay lit to remind you that the feature is set. You can review the Auto Night

Light settings by pressing **Auto Night Light**.

To erase your settings and turn off the automatic feature, press **Auto Night Light**, then 0.

Shelf (on some models)

How to Use the Shelf when Microwaving

Food microwaves best when placed on the turntable or on the shelf in the lower position.

NOTICE: Only use microwave shelf when reheating on more than one level. **DO NOT** store the oven shelf in the microwave.



⚠ WARNING ARCING:
If you see arcing, press the **Cancel/Off** button and correct the problem.

- Make sure the shelf is positioned properly inside the microwave to prevent damage to the oven from arcing.
- Do not use a microwave browning dish on the shelf. The shelf could overheat.
- Do not use the oven with the shelf on the microwave floor. This could damage the microwave.
- Use pot holders when handling the shelf—it may be hot.
- Do not use the shelf when cooking popcorn.
- Do not use the shelf with Sensor Cooking or Reheat.

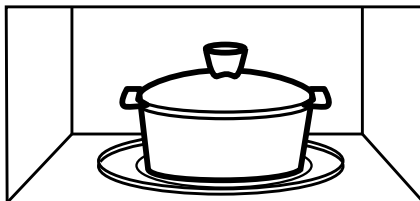

For best results

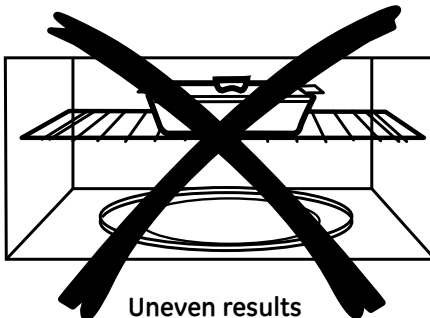
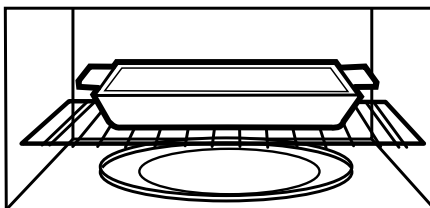

Uneven results

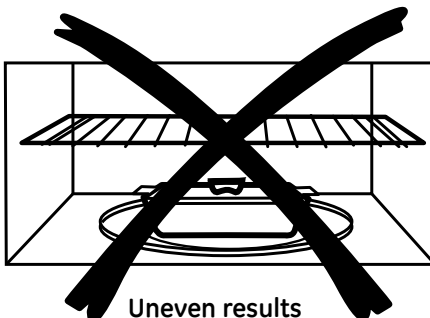

Uneven results

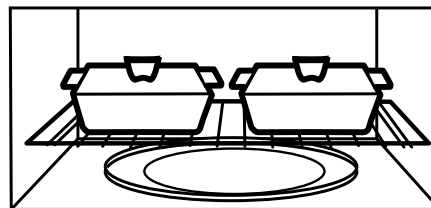

The shelf gives you the option to reheat more than one dish of food at the same time.

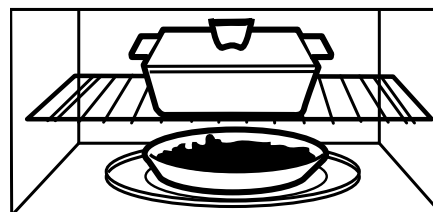

2-level reheating

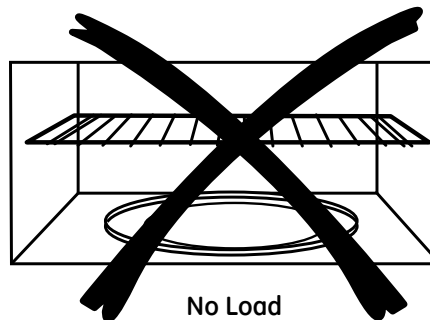

No Load

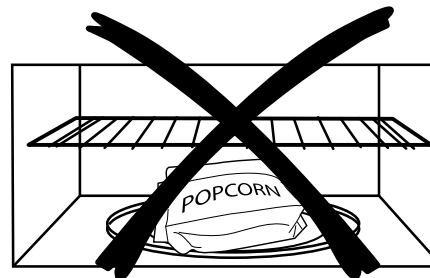

About other features.

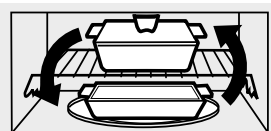

Switch places after 1/2 time.

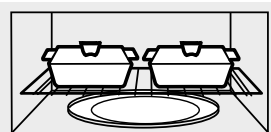

Switch places after 1/2 time.

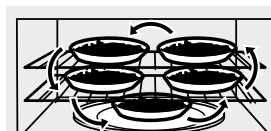

Switch places twice

Shelf and Reheating

- To reheat on 2 levels

or

- To reheat 2 dishes on the lower level:

- 1 Multiply reheat time by 1½.
- 2 Switch places after 1/2 the time.

- To reheat on 3 levels (on some models)

- 1 Double the reheating time.
- 2 Switch places twice and give the dishes a 1/2 turn during reheating. (Place dense foods, or those that require a longer cook time, on the upper shelf first.)

Microwave terms.

Arcing

Arcing is the microwave term for sparks in the oven. Arcing is caused by:

- Metal or foil touching the side of the oven.
- Foil that is not molded to food (upturned edges act like antennas).

- Metal such as twist-ties, poultry pins, gold-rimmed dishes.

- Recycled paper towels containing small metal pieces.

- Plates or dishes with a metallic trim or glaze with a metallic sheen.

Covering

Covers hold in moisture, allow for more even heating and reduce cooking time.

Venting plastic wrap or covering with wax paper allows excess steam to escape.

Shielding

In a regular oven, you shield chicken breasts or baked foods to prevent over-browning. When microwaving, you use small strips of foil to shield thin parts, such as the tips of wings

and legs on poultry, which would cook before larger parts.

Standing Time

When you cook with regular ovens, foods such as roasts or cakes are allowed to stand to finish cooking or to set.

Standing time is especially important in microwave cooking. Note that a microwaved cake is not placed on a cooling rack.

Venting

After covering a dish with plastic wrap, you vent the plastic wrap by turning back one corner so excess steam can escape.



Helpful Hints

An occasional thorough wiping with a solution of baking soda and water keeps the inside fresh.

Unplug the cord before cleaning any part of this oven.

How to Clean the Inside

Walls, Floor, Inside Window, Metal and Plastic Parts on the Door

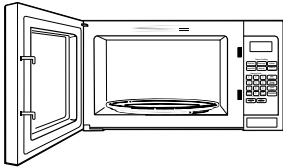

Some spatters can be removed with a paper towel; others may require a damp cloth. Remove greasy spatters with a sudsy cloth, then rinse with a damp cloth. Do not use abrasive cleaners or sharp utensils on oven walls.

To clean the surface of the door and the surface of the oven that come together upon closing, use only mild, nonabrasive soaps or detergents using a sponge or soft cloth. Rinse with a damp cloth and dry.

Never use a commercial oven cleaner on any part of your microwave.

Removable Turntable and Turntable Support

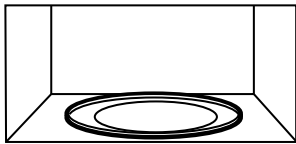

To prevent breakage, do not place the turntable into water just after cooking. Wash it carefully in warm, sudsy water or in the dishwasher. The turntable and support can be broken if dropped. Remember, do not operate the oven without the turntable and support in place.

How to Clean the Outside

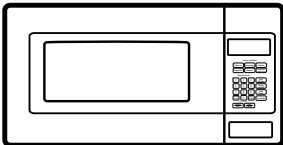

Do not use cleaners containing ammonia or alcohol on the microwave oven. Ammonia or alcohol can damage the appearance of the microwave.

Case

Clean the outside of the microwave with a sudsy cloth. Rinse with a damp cloth and then dry. Wipe the window clean with a damp cloth.

Control Panel and Door

Wipe with a damp cloth. Dry thoroughly. Do not use cleaning sprays, large amounts of soap and water, abrasives or sharp objects on the panel—they can damage it. Some paper towels can also scratch the control panel.

Door Surface

It is important to keep the area clean where the door seals against the microwave. Use only mild, non-abrasive detergents applied with a clean sponge or soft cloth. Rinse well.

Power Cord

If the cord becomes soiled, unplug and wash with a damp cloth. For stubborn spots, sudsy water may be used, but be certain to rinse with a damp cloth and dry thoroughly before plugging cord into outlet.

Stainless Steel (on some models)

Do not use a steel-wood pad; it will scratch the surface.

To clean the stainless steel surface, use a hot, damp cloth with a mild detergent suitable for stainless steel surfaces. Use a clean, hot, damp cloth to remove soap. Dry with a dry, clean cloth. Always scrub lightly in the direction of the grain.

Care and cleaning of the microwave oven.

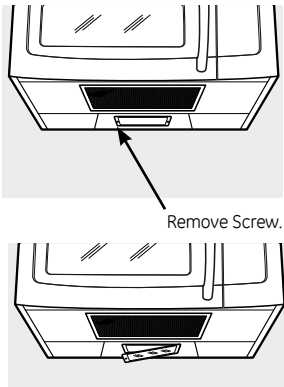

Cooktop Light/Night Light Replacement

Replace the burned-out bulb with a 120 volt, 40-watt incandescent bulb (WB36X10003), available from your GE supplier.

- 1 To replace the bulb(s), first disconnect the power at the main fuse or circuit breaker panel or pull the plug.
- 2 Remove the screw at the left of the light cover and lower the cover.

- 3 Be sure the bulb(s) to be replaced are cool before removing. After breaking the adhesive seal, remove the bulb by gently turning. Replace with the same size and type bulb.
- 4 Replace the screw. Connect electrical power to the oven.

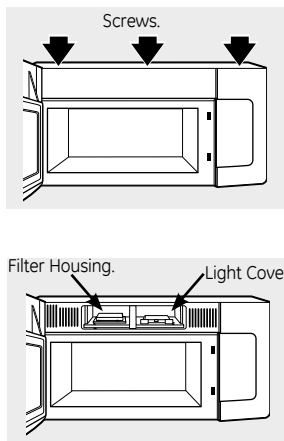

Oven Light Replacement

- 1 To replace the oven light, first disconnect the power at the main fuse or circuit breaker panel or pull the plug.
- 2 To remove the top grille, open the door and remove the 3 screws on top of the oven that hold the grille into place. Slide the grille to the left to remove it.
- 3 Lift the metal tab on the light cover located above the handle.
- 4 After breaking the adhesive seal, remove the bulb by gently turning. Replace with the same size and type bulb.

- 5 Replace the light cover.
- 6 Replace the grille and screws. Connect electrical power to the oven.

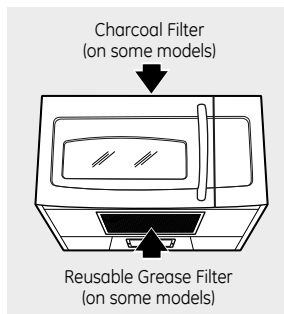

Vent Fan

The vent fan has a metal reusable grease filter.

Models that recirculate air back into the room also use a charcoal filter.

Reusable Grease Filter

The reusable grease filter traps grease released by foods on the cooktop. It also prevents flames from foods on the cooktop from damaging the inside of the microwave.

For this reason, the filter must ALWAYS be in place when the hood is used. The grease filter should be cleaned once a month, or as needed.

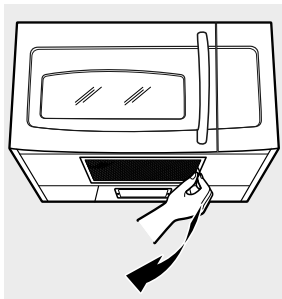

Removing and Cleaning the Filter

To remove, slide it to the side using the tab. Pull it down and out.

To clean the grease filter, soak it and then swish it around in hot water and detergent. Don't use ammonia or ammonia products because it will darken the metal. Light brushing can be used to remove embedded dirt.

Rinse, shake and let it dry before replacing.

To replace, slide the filter in the frame slot on the left side of the opening. Pull up and to the right to lock into place.

Charcoal Filter (on some models)

The charcoal filter cannot be cleaned. It must be replaced. Order Part No. JX81J (sales number) or WB02X1124 (service number) from your GE supplier.

If the model is not vented to the outside, the air will be recirculated through a disposable charcoal filter that helps remove smoke and odors. The charcoal filter should be replaced when it is noticeably dirty or discolored (usually after 6–12 months, depending on hood usage). See "Optional Kits," page 7, for more information.

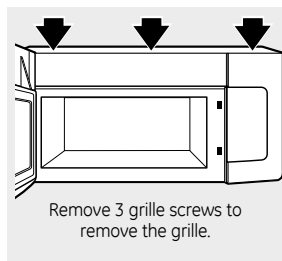

To Remove Charcoal Filter

To remove the charcoal filter, disconnect power at the main fuse or circuit breaker panel or pull the plug.

Remove the grille by opening the door and removing the 3 screws on top of the oven that hold the grille in place. Slide the grille to the left to remove it.

Push the filter at the bottom until it comes free of the locking tabs. Slide the filter down and out.

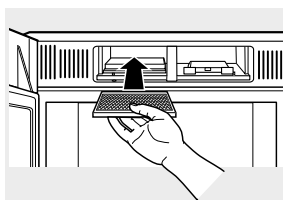
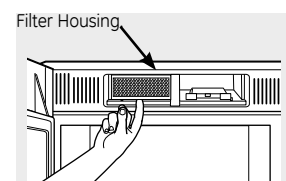

To Install Charcoal Filter

To install a new filter, remove plastic and other outer wrapping from the new filter.

Insert the filter into the left side of the front top opening of the oven as shown. It will rest at an angle on 2 side support tabs and in front of the right rear tab. Replace the grille and 3 screws.

Troubleshooting Tips.

Problem	Possible Cause	What to Do
Oven will not start	<p>A fuse in your home may be blown or the circuit breaker tripped.</p> <p>Power surge.</p> <p>Plug not fully inserted wall outlet.</p> <p>Door not securely closed.</p>	<ul style="list-style-type: none"> • Replace fuse or reset circuit breaker. • Unplug the microwave oven, then plug it back in. • Make sure the 3-prong plug on the into oven is fully inserted into wall outlet. • Open the door and close securely.
Floor of the oven is warm, even when the oven has not been used	Heat from the cooktop light may make the oven floor get warm.	<ul style="list-style-type: none"> • This is normal.
"LOCKED" appears on display	The control has been locked.	<ul style="list-style-type: none"> • Press and hold CLEAR/OFF for about 3 seconds to unlock the control.
You hear an unusual, low-tone beep	<p>You have tried to start the Reminder without a valid time of day.</p> <p>You have tried to change the power level when it is not allowed.</p>	<ul style="list-style-type: none"> • Start over and enter a valid time of day. • Many of the oven's features are preset and cannot be changed.
"SENSOR ERROR" appears on display	<p>When using a Sensor feature, the door was opened before steam could be detected.</p> <p>Steam not detected in maximum amount of time.</p>	<ul style="list-style-type: none"> • Do not open door until steam is sensed and time is shown counting down on display. • Use Time Cook to heat for more time.
Food amount too large for Sensor Reheat	Sensor Reheat is for single servings of recommended foods.	<ul style="list-style-type: none"> • Use Time Cook for large amounts of food.

Things That Are Normal With Your Microwave Oven

- Steam or vapor escaping from around the door.
- Light reflection around door or outer case.
- Dimming oven light and change in the blower sound at power levels other than high.
- Dull thumping sound while oven is operating.
- TV/radio interference might be noticed while using the microwave. Similar to the interference caused by other small appliances, it does not indicate a problem with the microwave. Plug the microwave into a different electrical circuit, move the radio or TV as far away from the microwave as possible, or check the position and signal of the TV/radio antenna.

Notes

Notes

Please place in envelope and mail to:
Veuillez mettre dans une enveloppe et envoyez à :

**OWNERSHIP REGISTRATION
P.O. BOX 1780
MISSISSAUGA, ONTARIO
L4Y 4G1**

**(FOR CANADIAN CONSUMERS ONLY -
POUR RÉSIDENTS CANADIENS SEULEMENT)**



For Canadian
Customers



Pour les
consommateurs
canadiens

CUT ALONG THIS LINE AND RETURN CARD - THANKS
DÉCOUPEZ ICI ET ENVOYEZ LA FICHE - MERCI

OWNERSHIP REGISTRATION CERTIFICATE – FICHE D'INSCRIPTION DU PROPRIÉTAIRE

Please register your product to enable us to contact you in the remote event a safety notice is issued for this product and to allow for efficient communication under the terms of our warranty, should the need arise.

Veuillez enregistrer votre produit afin de nous permettre de communiquer avec vous si jamais un avis de sécurité concernant ce produit était émis et de communiquer facilement avec vous en vertu de votre garantie, si le besoin s'en fait sentir.

REGISTER ON-LINE: ENREGISTREMENT SUR INTERNET À :		www.geappliances.ca		MAIL TO: POSTEZ À :	P.O. BOX 1780, MISSISSAUGA
		www.electromenagersge.ca		ONTARIO, L4Y 4G1	
<input type="checkbox"/> MR. / M.	<input type="checkbox"/> MRS. / MME	FIRST NAME / PRÉNOM		LAST NAME / NOM	
<input type="checkbox"/> MISS/MILLE	<input type="checkbox"/> MS.				
STREET NO / N° RUE		STREET NAME / RUE			APT.NO/APP./RR#
CITY / VILLE				PROVINCE	POSTAL CODE/CODE POSTAL
AREA CODE/IND. RÉG.	TELEPHONE/TÉLÉPHONE	E-MAIL/COURRIEL			
DID YOU PURCHASE A SERVICE CONTRACT FOR THIS APPLIANCE? AVEZ-VOUS ACHETÉ UN CONTRAT DE SERVICE POUR CET APPAREIL ?				YES/OUI <input type="checkbox"/>	IF YES/SI OUI : EXPIRATION Y/A M DU
				NO/NON <input type="checkbox"/>	
NAME OF SELLING DEALER / NOM DU MARCHAND				MODEL / MODÈLE	
INSTALLATION DATE / DATE D'INSTALLATION Y/A M DU		CORRESPONDENCE	<input type="checkbox"/> ENGLISH	SERIAL / SÉRIE	
		CORRESPONDANCE	<input type="checkbox"/> FRANÇAIS		
<input type="checkbox"/> I do not wish to receive any promotional offers regarding this product. Je ne désire pas recevoir d'offres promotionnelles concernant ce produit.					

GE Microwave Oven Warranty.



All warranty service provided by our Factory Service Centers, or an authorized Customer Care® technician. To schedule service, online, contact us at GEAppliances.ca, or call 1.800.561.3344. Please have serial and model numbers available when calling for service.

Staple your receipt here. Proof of the original purchase date is needed to obtain service under the warranty.

For The Period Of:	Mabe Will Replace:
One Year <i>From the date of the original purchase</i>	Any part of the oven which fails due to a defect in materials or workmanship. During this limited one-year warranty , Mabe will also provide, free of charge , all labor and related service costs to replace the defective part.

What Mabe Will Not Cover:

- Service trips to your home to teach you how to use the product.
- Improper installation, delivery or maintenance.
- Product not accessible to provide required service.
- Failure of the product or damage to the product if it is abused, misused (for example, cavity arcing from wire rack or metal/foil), or used for other than the intended purpose or used commercially.
- Replacement of house fuses or resetting of circuit breakers.
- Replacement of the cooktop light bulbs.
- Damage to the product caused by accident, fire, floods or acts of God.
- Incidental or consequential damage caused by possible defects with this appliance.
- Damage caused after delivery.

EXCLUSION OF IMPLIED WARRANTIES—Your sole and exclusive remedy is product exchange as provided in this Limited Warranty. Any implied warranties, including the implied warranties of merchantability or fitness for a particular purpose, are limited to one year or the shortest period allowed by law.

This warranty is extended to the original purchaser and any succeeding owner for products purchased for home use within Canada. If the product is located in an area where service by a Mabe Canada Authorized Servicer is not available, you may be responsible for a trip charge or you may be required to bring the product to an Authorized Mabe Canada Service Location for service.

Some provinces do not allow the exclusion or limitation of incidental or consequential damages. This warranty gives you specific legal rights, and you may also have other rights which vary from province to province. To know what your legal rights are, consult your local or provincial consumer affairs office.

Exclusion of implied warranties: Except where prohibited or restricted by law, there are no warranties, whether express, oral or statutory which extend beyond the description on the face hereof, including specifically the implied warranties of merchantability or fitness for a particular purpose.

Warrantor: Mabe Canada Inc., Burlington, Ontario

Consumer Support.



GE Appliances Website

GEAppliances.ca

Have a question or need assistance with your appliance? Try the GE Appliances Website 24 hours a day, any day of the year! For greater convenience and faster service, you can now download Owner's Manuals, order parts, catalogs.

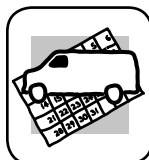

Schedule Service

GEAppliances.ca

Expert Mabe repair service is only one step away from your door. Get on-line and schedule your service at your convenience any day of the year! Or call 1.800.561.3344 during normal business hours.



Service Contracts

GEAppliances.ca

Purchase a Mabe extended warranty and learn about special discounts that are available while your warranty is still in effect. You can purchase it on-line anytime, or call 1.800.461.3636 during normal business hours. Mabe Consumer Home Services will still be there after your warranty expires.

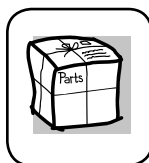

Parts and Accessories

GEAppliances.ca

Individuals qualified to service their own appliances can have parts or accessories sent directly to their homes (VISA, MasterCard and Discover cards are accepted). Order on-line today, 24 hours every day or by phone at 1.800.661.1616 during normal business hours.

Instructions contained in this manual cover procedures to be performed by any user. Other servicing generally should be referred to qualified service personnel. Caution must be exercised, since improper servicing may cause unsafe operation.

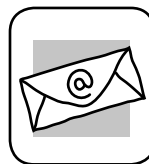

Contact Us

GEAppliances.ca

If you are not satisfied with the service you receive from Mabe, contact us on our Website with all the details including your phone number, or write to:

General Manager, Customer Relations
Mabe Canada Inc,
Suite 310, 1 Factory Lane,
Moncton NB E1C 9M3



Register Your Appliance

GEAppliances.ca

Register your new appliance on-line—at your convenience! Timely product registration will allow for enhanced communication and prompt service under the terms of your warranty, should the need arise. You may also mail in the pre-printed registration card included in the packing material.