

Top Freezer Refrigerator

moffatappliances.ca

Safety Instructions 2, 3

Operating Instructions

Control Settings 4
Storage Drawers 4
Ice Service 5
Care and Cleaning 6, 7

Installation Instructions

Advanced Planning 8
Refrigerator Features 9
Reversing the Door Swing 10, 11

Troubleshooting Tips

Normal Operating Sounds 12
Problem Solver 13, 14

Consumer Support

Warranty 15
Consumer Support Back Page

**Owner's Manual and
Installation Instructions**

MPE12FG
MPE12FS

Congélateur supérieur
Réfrigérateurs

**Manuel d'utilisation
et d'installation**

La section française commence à la page 17

Write the model and serial
numbers here:

Model # _____

Serial # _____

You can find them on a label inside
the refrigerator.

IMPORTANT SAFETY INFORMATION. READ ALL INSTRUCTIONS BEFORE USING.

IMPORTANT SAFETY INFORMATION READ ALL INSTRUCTIONS BEFORE USING



Moffat Appliances website

For more information on your refrigerator's operation, visit www.moffatappliances.ca or call 800.561.3344

REFRIGERATOR SAFETY INFORMATION

! This is the safety alert symbol. This symbol alerts you to potential hazards that can kill or hurt you and others. All safety messages will follow the safety alert symbol and the word "DANGER", "WARNING", or "CAUTION". These words are defined as:

! DANGER Indicates a hazardous situation which, if not avoided, **will** result in death or serious injury.

! WARNING Indicates a hazardous situation which, if not avoided, **could** result in death or serious injury.

! CAUTION Indicates a hazardous situation which, if not avoided, **could** result in minor or moderate injury.

IMPORTANT SAFETY INSTRUCTIONS

! WARNING To reduce the risk of fire, explosion, electric shock, or injury when using your refrigerator follow these basic safety precautions:

- This refrigerator must be properly installed and located in accordance with the Installation Instructions before it is used.
- Do not allow children to climb, stand or hang on the shelves in the refrigerator. They could damage the refrigerator and seriously injure themselves.
- Do not touch the cold surfaces in the freezer compartment, particularly when hands are damp or wet. Skin may stick to these extremely cold surfaces.
- Do not store or use gasoline or other flammable vapors and liquids in the vicinity of this or any other appliance.
- In refrigerators with automatic ice makers, avoid contact with the moving parts of the ejector mechanism, or with the heating element that releases the cubes. Do not place fingers or hands on the automatic ice making mechanism while the refrigerator is plugged in.
- Keep fingers out of the "pinch point" areas; clearances between the doors and between the doors and cabinet are necessarily small. Be careful closing doors when children are in the area.
- Unplug the refrigerator before cleaning and making repairs.
NOTE: We strongly recommend that any servicing be performed by a qualified individual.
- Turning the control to the **COLD** position does not remove power to the light circuit.
- Do not refreeze frozen foods which have thawed completely.
- **Before replacing a burned-out light bulb, the refrigerator should be unplugged** in order to avoid contact with a live wire filament. (A burned-out light bulb may break when being replaced.)

IMPORTANT SAFETY INFORMATION. READ ALL INSTRUCTIONS BEFORE USING.

moftatappliances.ca

WARNING **Explosion Hazard.**

Keep flammable materials and vapors, such as gasoline, away from refrigerator. Failure to do so can result in fire, explosion, or death.

CONNECTING ELECTRICITY

WARNING **Electrical Shock Hazard.**

Plug into a grounded 3-prong outlet
Do not remove the ground prong
Do not use an adapter
Failure to follow these instructions can result in death, fire, or electrical shock.



Do not, under any circumstances, cut or remove the third (ground) prong from the power cord. For personal safety, this appliance must be properly grounded.

The power cord of this appliance is equipped with a 3-prong (grounding) plug which mates with a standard 3-prong (grounding) wall outlet to minimize the possibility of electric shock hazard from this appliance.

Have the wall outlet and circuit checked by a qualified electrician to make sure the outlet is properly grounded.

Where a standard 2-prong wall outlet is encountered, it is your personal responsibility and obligation to have it replaced with a properly grounded 3-prong wall outlet. Do not use an adapter.

The refrigerator should always be plugged into its own individual electrical outlet which has a voltage rating that matches the rating plate.

This provides the best performance and also prevents overloading house wiring circuits which could cause a fire hazard from overheated wires.

Never unplug your refrigerator by pulling on the power cord. Always grip plug firmly and pull straight out from the outlet.

Repair or replace immediately all power cords that have become frayed or otherwise damaged. Do not use a cord that shows cracks or abrasion damage along its length or at either end.

When moving the refrigerator away from the wall, be careful not to roll over or damage the power cord.

PROPER DISPOSAL OF YOUR OLD REFRIGERATOR

WARNING **Suffocation and child entrapment hazard.**

Remove fresh-food and freezer doors from the refrigerator, prior to disposal. Failure to do so can result in child entrapment which can lead to death or brain damage.

IMPORTANT:

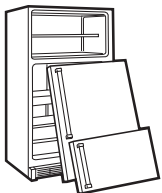

Child entrapment and suffocation are not problems of the past. Junked or abandoned refrigerators are still dangerous even if they will sit for "just a few days." If you are getting rid of your old refrigerator, please follow the instructions below to help prevent accidents.

Before You Throw Away Your Old Refrigerator or Freezer:

- Take off the fresh food and freezer doors.
- Leave the shelves in place so that children may not easily climb inside.

Refrigerants

All refrigeration products contain refrigerants, which under federal law must be removed prior to product disposal. If you are getting rid of an old refrigeration product, check with the company handling the disposal about what to do.



**READ AND FOLLOW THIS SAFETY INFORMATION CAREFULLY.
SAVE THESE INSTRUCTIONS**

About the control on the refrigerator.

The temperature control is located in the fresh food compartment. Initially set the control to the 3 setting. Allow 24 hours for temperature to stabilize.

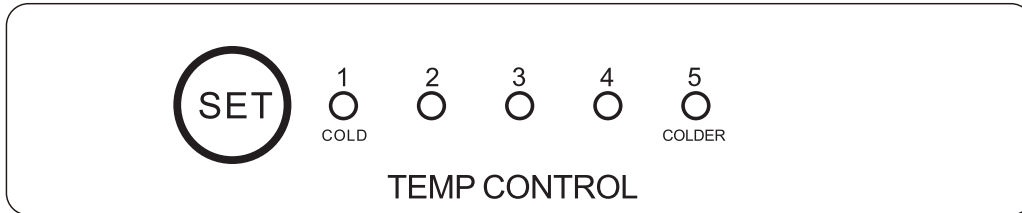

Fresh Food Temp Control

Control Settings

The control in the fresh food compartment should be adjusted one increment at a time. Allow 12 hours after each adjustment for the compartment to reach the temperature you have set. The freezer compartment will be colder when the fresh food compartment temperature is lower.

Control settings will vary based on personal preferences, usage and operating conditions and may require more than one adjustment. Factors that affect temperature include the amount of food in the fresh food and freezer compartments, frequency of door opening, and temperature of food when placed in either compartment.

Thermistor

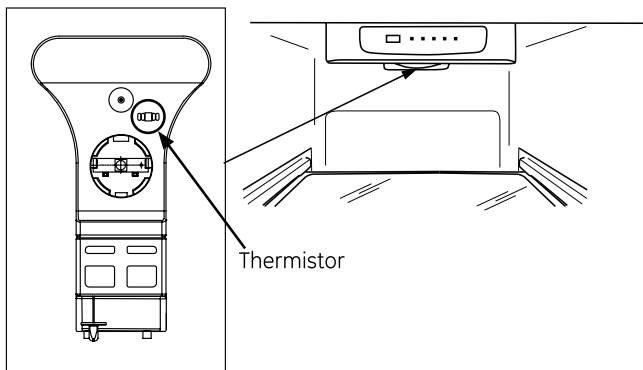

The thermistor located at the bottom of the fresh food control housing is one of the key elements for temperature control. Keep all items away from blocking the thermistor as this will reduce the sensitivity of the thermistor and cause temperature issues. Food may freeze or become too warm depending on the compressor cycle if the air flow is blocked.

About the storage drawers.

Fruit and Vegetable Drawers

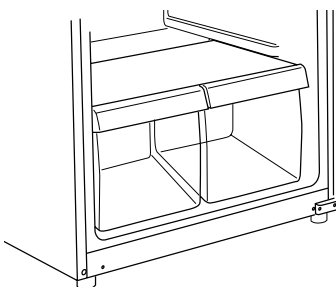

These storage drawers provide space to store fruits, vegetables and meats.

To remove and replace the drawers and the cover above them, the door must be fully opened. In some installations, the refrigerator may have to be moved away from the wall for the door to be fully opened.

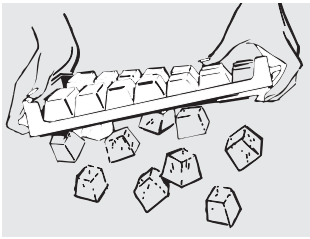

Ice Trays

To make ice, fill the ice tray with water and set it on a level surface in the freezer compartment. Ice cubes will form in a few hours.

To release ice cubes, turn the tray upside down, hold it over a container and twist both ends.

For only one or two ice cubes, leave the tray right-side up, twist both ends slightly and remove as many cubes as you want.

Wash ice trays in lukewarm water only—do not put them in an automatic dishwasher.

Care and cleaning of the refrigerator.

Cleaning the Outside

Keep the outside clean. Wipe with a clean cloth lightly dampened with mild liquid dish detergent. Dry with a clean, soft cloth.

Do not wipe the stainless steel door with a soiled dishcloth or wet towel. These may leave a residue that can erode the finish. Do not use scouring pads, powdered cleaners, bleach or cleaners containing bleach because these products can scratch and weaken the finish. Use only a liquid cleanser free of grit and rub in the direction of the brush lines.

The stainless steel door and door handle can be cleaned with a commercially available stainless steel cleaner. Cleaners with oxalic acid (e.g. Bar Keepers Friend Soft Cleanser) will remove rust, lime, and other tarnish. Do not use appliance wax or polish on the stainless steel.

Protect the paint finish. The finish on the outside of the refrigerator is a high quality, baked-on paint finish. With proper care, it will stay new-looking and rust free for years. Apply a coat of kitchen/appliance wax when the refrigerator is new, and then at least twice a year.

Cleaning the Inside

To help prevent odors, leave an open box of baking soda in the fresh food and freezer compartments.

Unplug the refrigerator before cleaning.

If this is not practical, wring excess moisture out of sponge or cloth when cleaning around switches, lights or controls.

Use warm water and baking soda solution—about a tablespoon (15 ml) of baking soda to a quart (1 liter) of water. This both cleans and neutralizes odors. Rinse and wipe dry.

Other parts of the refrigerator—including door gaskets, fruit and vegetable drawers, and all plastic parts—can be cleaned the same way.

After cleaning the door gaskets, apply a thin layer of petroleum jelly to the door gaskets at the hinge side. This helps keep the gaskets from sticking and bending out of shape. Do not use cleansing powders or other abrasive cleaners.

Do not wash any plastic refrigerator parts in the dishwasher.

Avoid cleaning cold glass shelves (on some models) with hot water because the extreme temperature difference may cause them to break. Handle glass shelves carefully. Bumping tempered glass can cause it to shatter.

Replacing the Light Bulb

! WARNING: Light bulb may be hot. Before replacing a burned-out light bulb, the refrigerator should be unplugged in order to avoid contact with a live wire filament (A burned-out light bulb may break when being replaced.) Turning the control to the OFF position does not remove power to the light circuit. Maximum bulb wattage: 15W

- 1 Unplug the refrigerator
- 2 The bulb is located at the top of the refrigerator compartment. Unfasten screw to remove light cover.
- 3 Replace bulb with a new one of the same or lower wattage
- 4 Reattach light cover using screw

- 5 Plug the refrigerator back in

CAUTION

Using a bulb rated higher than 15W may damage the control housing and light lens.

Preparing for Vacation

For long vacations or absences, remove food and unplug the refrigerator. Clean the interior with a baking soda solution of one tablespoon (15 ml) of baking soda to one quart (1 liter) of water. Leave the doors open.

Preparing to Move

Remove food and unplug the refrigerator. Secure all loose items such as shelves and drawers by taping them securely in place to prevent damage.

Be sure the refrigerator stays in an upright position during moving.

Installation Instructions

Refrigerator

Models MPE12FG
MPE12FS

If you have questions, call 1.800.561.3344 or Visit our Website at:
www.moffatappliances.ca

BEFORE YOU BEGIN

Read these instructions completely and carefully.

- **IMPORTANT** – Save these instructions for local inspector's use.
- **IMPORTANT** – Observe all governing codes and ordinances.
- **Note to Installer** – Be sure to leave these instructions with the Consumer.
- **Note to Consumer** – Keep these instructions for future reference.
- Skill level – Installation of this appliance requires basic mechanical skills.
- Completion time – Refrigerator Installation
15 minutes
Reversing the Door Swing
1 hour
- Proper installation is the responsibility of the installer.
- Product failure due to improper installation is not covered under the Warranty.

LOCATION REQUIREMENTS

- Do not install the refrigerator where the temperature will go below 55°F (13°C) because it will not run often enough to maintain proper temperatures.
- Install it on a floor strong enough to support it fully loaded.

CLEARANCES

- Free-standing installation only.
- If the refrigerator is being installed next to a wall, leave sufficient space on the hinge side to allow the door to swing open enough to access the clear bins in the refrigerator compartment.
- Do not install within 5" (13 cm) of the range.
- Minimum Clearances:
Back – 3" from the wall

UNPACKING YOUR REFRIGERATOR

- Remove tape and any labels (except for the rating label) from your refrigerator. Tape or glue residue can also be removed by rubbing a small amount of liquid dish soap over the adhesive with your fingers. Wipe with warm water and dry.
- Do not use sharp instruments, rubbing alcohol, flammable fluids, or abrasive cleaners to remove tape or glue. These products can damage the surface of your refrigerator.
- When moving the refrigerator, do not tilt the refrigerator beyond 45° from upright position.

LEVELING LEGS

Adjustable legs at the front corners of the refrigerator should be set so the refrigerator is firmly positioned on the floor, and the front is raised just enough that the door closes easily when opened about halfway.

To adjust the leveling legs, turn the legs **clockwise** to raise the refrigerator, **counterclockwise** to lower it.

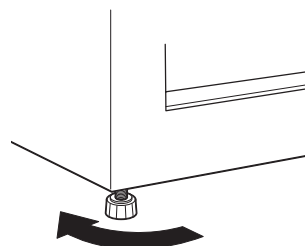

To raise the refrigerator

POWER CORD

- Plug the refrigerator power cord into its own properly grounded wall outlet with a voltage rating matching that on the refrigerator rating plate.
- Do not use an extension cord.
- Read all safety precautions on pages 2 and 3.

Installation Instructions

REFRIGERATOR FEATURES

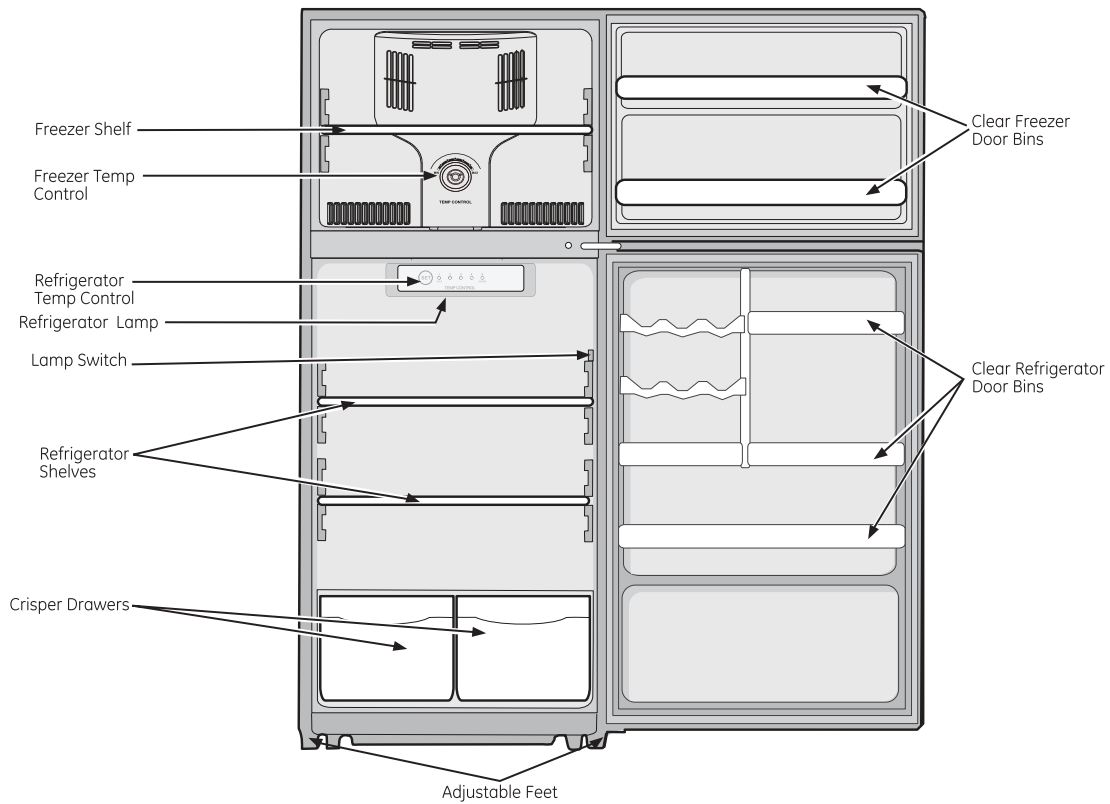

Installation Instructions

REVERSING THE DOOR SWING

IMPORTANT NOTES

When reversing the door swing:

- Read the instructions all the way through before starting.
- Handle parts carefully to avoid scratching paint.
- Set screws down by their related parts to avoid using them in the wrong places.
- Provide a non-scratching work surface for the doors.
- It is recommended that 2 people perform this task.

IMPORTANT: Once you begin, do not move the cabinet until door-swing reversal is completed.

These instructions are for changing the hinges from the right side to the left side—if you ever want to change the hinges back to the right side, follow these same instructions and reverse all references to left and right.

Unplug the refrigerator from its electrical outlet.

Empty all door shelves.

TOOLS YOU WILL NEED



8 mm Socket driver

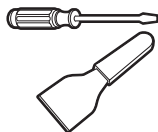

Putty knife or thin-blade screwdriver



Phillips screwdriver



Masking tape

1 REMOVE THE FREEZER DOOR

Remove the hinge cover. Unscrew and remove the top hinge.

Lift the freezer door up and away from the appliance.

Set the door on a non-scratching surface with the outside up.

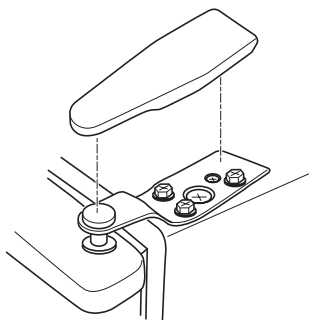

CAUTION Do not let door drop to the floor. Doing so could damage the door stop.

2 REMOVE THE FRESH FOOD DOOR

Tape the door shut with masking tape.

Remove the center hinge by removing the screws. Lift up the hinge to remove it.

NOTE: Some models have a washer between the center hinge and the top of the fresh food door. Be careful not to lose them.

Remove the tape holding the door shut.

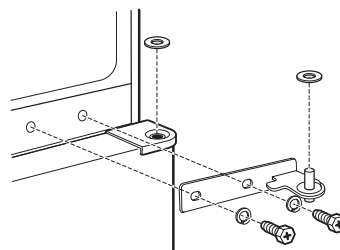

Lift the fresh food door up and off the bottom hinge.

Set the door outside-up on a non-scratching surface.

NOTE: When removing the door, watch for washer(s) between the bottom hinge and the bottom of the fresh food door that may stick to the door. Do not lose.



CAUTION Do not let door drop to the floor. Doing so could damage the door stop.

3 BOTTOM HINGE

Remove the screws and bottom hinge from the right side. Remove the screw covers from the left corner.

Using the left hinge included with the parts that came with your refrigerator along with the screws (and washers if applicable) removed earlier, install the left hinge onto the bottom left of your refrigerator.

Place the screw covers into the holes now vacant on the right.

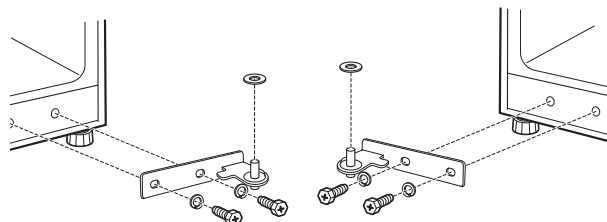

Installation Instructions

REVERSING THE DOOR SWING (CONT.)

4 TRANSFER FRESH FOOD DOOR STOP TO THE LEFT

Remove the door stop from the bottom of the right side of the door. Transfer the screw covers from the bottom left side to the right side.

Using the left door stop included with the parts that came with your refrigerator, install the left door stop.

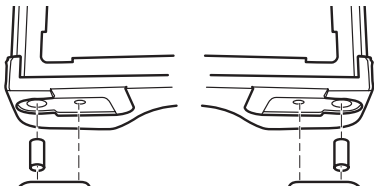

5 REHANG THE FRESH FOOD DOOR

Make sure the washer(s) are in place on the bottom hinge pin. Make sure the door is aligned horizontally and vertically. Place the fresh food door on the bottom hinge, close the door and tape it in place with masking tape.

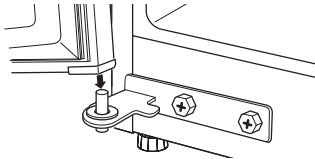

Remove the screw covers from the left edge of the door and insert it into the hole on the opposite side.

Screw Covers

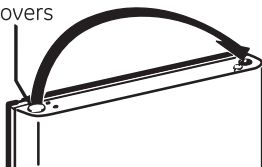

6 INSTALL CENTER HINGE ON THE LEFT

Remove the three screw covers on the left side and install two of them on the right.

Using the middle hinge and screws (and washers if applicable) removed earlier, install the left middle hinge on the left side.

Remove the tape holding the door shut.

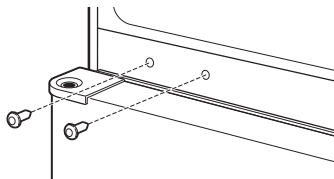

CAUTION

When assembled correctly, the hinge is tight against the cabinet.

6 INSTALL CENTER HINGE ON THE LEFT (CONT.)

ATTENTION: The screws must be properly tightened.

Turn the screws until snug. Then tighten the screws a minimum of 1/2 turn using both hands.

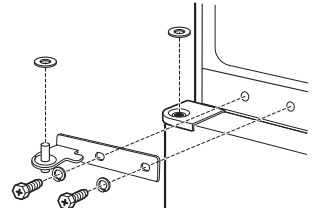

7 TRANSFER TOP HINGE TO THE LEFT

Using a putty knife with the edge covered with masking tape, remove the screw cover on the left. Be careful of the paint finish.

Reinstall the screw cover on the right side.

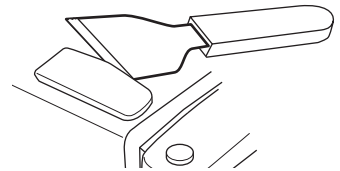

8 TRANSFER FREEZER DOOR STOP TO THE LEFT

Remove the door stop from the bottom of the right side of the door. Transfer the screw covers from the bottom left side to the right side.

Using the left door stop included with the parts that came with your refrigerator, install the left door stop.

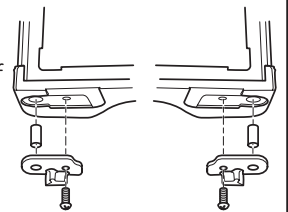

9 REHANG THE FREEZER DOOR

Transfer the screw cover on top of the door to the opposite side.

Place the freezer door on the center hinge over the pin. Assure the door is aligned horizontally and vertically, and that the gasket seals on all sides.

Attach the top hinge removed earlier on the left side of your refrigerator and replace the hinge cover

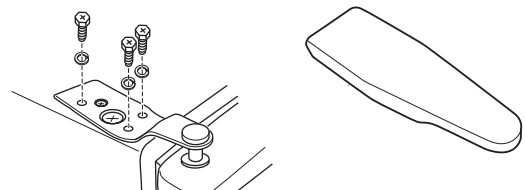

Normal operating sounds.



Newer refrigerators sound different from older refrigerators. Modern refrigerators have more features and use newer technology.

Do you hear what I hear? These sounds are normal.

HUMMM... WHOOSH...

- The new high efficiency compressor may run faster and longer than your old refrigerator and you may hear a high-pitched hum or pulsating sound while it is operating.
- You may hear a whooshing sound when the doors close. This is due to pressure equalizing within the refrigerator.

WHIR!



- You may hear the fans spinning at high speeds. This happens when the refrigerator is first plugged in, when the doors are opened frequently or when a large amount of food is added to the refrigerator or freezer compartments. The fans are helping to maintain the correct temperatures.

CLICKS, POPS, CRACKS and CHIRPS

- You may hear cracking or popping sounds when the refrigerator is first plugged in. This happens as the refrigerator cools to the correct temperature.
- The compressor may cause a clicking or chirping sound when attempting to restart (this could take up to 5 minutes).
- Expansion and contraction of cooling coils during and after defrost can cause a cracking or popping sound.
- On models with an ice maker, after an ice making cycle, you may hear the ice cubes dropping into the ice bucket.

WATER SOUNDS



- The flow of refrigerant through the freezer cooling coils may make a gurgling noise like boiling water.
- Water dropping on the defrost heater can cause a sizzling, popping or buzzing sound during the defrost cycle.
- A water dripping noise may occur during the defrost cycle as ice melts from the evaporator and flows into the drain pan.
- Closing the door may cause a gurgling sound due to pressure equalization.

Before you call for service...

moffatappliances.ca



Troubleshooting Tips
Save time and money! Review the charts on the following pages first and you may not need to call for service.

Problem	Possible Causes	What To Do
Refrigerator does not operate	Refrigerator in defrost cycle.	Wait about 30 minutes for defrost cycle to end.
	Refrigerator is unplugged.	Push the plug completely into the outlet.
	The fuse is blown/circuit breaker is tripped.	Replace fuse or reset the breaker.
Vibration or rattling (slight vibration is normal)	Front leveling legs need adjusting.	See Leveling Legs.
Motor operates for long periods or cycles on and off frequently. (Modern refrigerators with more storage space and a larger freezer require more operating time. They start and stop often to maintain even temperatures.)	Normal when refrigerator is first plugged in.	Wait 24 hours for the refrigerator to completely cool down.
	Often occurs when large amounts of food are placed in refrigerator.	This is normal.
	Door left open.	Check to see if a package is holding door open.
	Hot weather or frequent door openings.	This is normal.
	Temperature control set at the coldest setting.	See About the control.
Fresh food or freezer compartment too warm	Temperature control not set cold enough.	See About the control.
	Warm weather or frequent door openings.	Set the temperature control one step colder. See About the control.
	Door left open.	Check to see if a package is holding door open.
Frost or ice crystals on frozen food (frost within package is normal)	Door left open.	Check to see if a package is holding door open.
	Too frequent or too long door openings.	
Ice cubes have odor/taste	Food transmitting odor/taste to ice cubes.	Wrap foods well.
	Interior of refrigerator needs cleaning.	See Care and cleaning.
Slow ice cube freezing	Door left open.	Check to see if package is holding door open.
	Temperature control not set cold enough.	See About the control.
Refrigerator has odor	Foods transmitting odor to refrigerator.	Foods with strong odors should be tightly wrapped. Keep an open box of baking soda in the refrigerator; replace every three months.
	Interior needs cleaning.	See Care and cleaning.
Moisture forms on outside of refrigerator	Not unusual during periods of high humidity.	Wipe surface dry.
Moisture collects inside (in humid weather, air carries moisture into refrigerator when doors are opened)	Too frequent or too long door openings.	

Before you call for service...



Troubleshooting Tips
 Save time and money! Review the charts on the following pages first and you may not need to call for service.

Problem	Possible Causes	What To Do
Interior light does not work	No power at outlet.	Replace fuse or reset the breaker.
	Light bulb burned out.	See <i>Replacing the light bulb</i> .
Food is freezing in the refrigerator	Food too close to the air vent at the back of the refrigerator.	Move the food away from the air vent.
	Refrigerator control is set too cold.	Move the refrigerator control to a warmer temperature setting one increment at a time. See <i>About the controls</i> .
Rust, tarnish, or grime on stainless steel doors	Moist environment or salt air.	Clean stainless steel with cleaners containing oxalic acid (e.g. Bar Keepers Friend Soft Cleanser) will remove rust, lime, and other tarnish. Do not wipe the refrigerator with a soiled dish cloth or wet towel. Do not use scouring pads, powdered cleaners, bleach or cleaners containing bleach because these products can scratch and ruin the brush finish of the stainless steel.

Refrigerator Warranty.



All warranty service provided by our Factory Service Centers, or an authorized Customer Care® technician. To schedule service call 1-800-561-3344. Please have serial number and model number available when calling for service.

Staple your receipt here. Proof of the original purchase date is needed to obtain service under the warranty.

For The Period Of:	MC COMMERCIAL Will Replace
One Year From the date of the original purchase	Any part of the refrigerator which fails due to a defect in materials or workmanship. During this limited one-year warranty , Moffat will also provide, free of charge , all labor and related service to replace the defective part.

What MC COMMERCIAL Will Not Cover:

- Service trips to your home to teach you how to use the product.
- Improper installation, delivery or maintenance.
- Failure of the product if it is abused, misused, or used for other than the intended purpose or used commercially.
- Loss of food due to spoilage.
- Replacement of house fuses or resetting of circuit breakers.
- Damage caused after delivery.
- Replacement of the water filter cartridge, if included, due to water pressure that is outside the specified operating range or due to excessive sediment in the water supply.
- Replacement of the light bulbs, if included, or water filter cartridge, if included, other than as noted above.
- Damage to the product caused by accident, fire, floods or acts of God.
- Incidental or consequential damage caused by possible defects with this appliance.
- Product not accessible to provide required service.

EXCLUSION OF IMPLIED WARRANTIES-Your sole and exclusive remedy is product repair as provided in this Limited Warranty. Any implied warranties, including the implied warranties of merchantability or fitness for a particular purpose, are limited to one year or the shortest period allowed by law.

This warranty is extended to the original purchaser and any succeeding owner for products purchased in Canada for home use within Canada.

In-home warrant service will be provided in areas where it is available and deemed reasonable by MC Commercial to provide.

Warrantor: MC COMMERCIAL, Burlington, ON L7R 5B6

Consumer Support.



Schedule Service

Expert repair service is only one step away from your door.
Call 1.800.561.3344 during normal business hours.



Real Life Design Studio

We supports the Universal Design concept-products, services and environments that can be used by people of all ages, sizes and capabilities. We recognize the need to design for a wide range of physical and mental abilities and impairments. For details of our Universal Design applications, including kitche design ideas for people with disabilities, check out our Website today.

In Canada, contact: Director, Customer Relations, MC Commercial
 Bureau 310, 1 Factory Lane
 Moncton, N.B. E1C 9M3



Extended Warranties

Please consult your local listings for extended warranty suppliers.

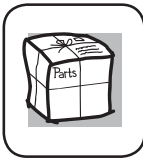

Parts and Accessories

Consult the yellow pages for the nearest authorized parts distributor, or call 1.800.661.1616.

Instructions contained in this manual cover procedures to be performed by any user.

Other servicing generally should be referred to qualified service personnel. Caution must be exercised, since improper servicing may cause unsafe operation.



Contact Us

If you are not satisfied with the service you receive, contact us on our Website with all the details including your phone number, or write to:

Director, Customer Relations, MC Commercial
Bureau 310, 1 Factory Lane
Moncton, N.B. E1C 9M3



Register Your Appliance

GEAppliances.ca

Register your new appliance on-line-at your convenience! Timely product registration will allow for enhanced communication and prompt service under the terms of your warranty, should the need arise.

You may also mail in the pre-printed registration card included in the packing material.