

Owner's Manual

Bottom-Freezer
Built-In Refrigerators

Introduction

Your new Monogram refrigerator makes an eloquent statement of style, convenience and kitchen planning flexibility. Whether you chose it for its purity of design, practical storage arrangements or assiduous attention to detail—or for all of these reasons—you'll find that your Monogram refrigerator's superior blend of form and function will delight you for years to come.

The information on the following pages will help you operate and maintain your refrigerator properly.

If you have any other questions, visit our Website at: monogram.com

Contents

Consumer Services

Important Phone Numbers	19
Model and Serial Numbers	3
Performance Data Sheet	17
Problem Solver	15, 16
Product Registration	3
Safety Instructions	4–7
Warranty	Back Cover

Care and Cleaning

Cleaning—Outside and Inside	13
Light Bulb Replacement	14
Master Light Switch	14
Vacation	14

Operating Instructions

Automatic IceMaker	10
Sabbath Mode Product Kit, ZSAB1	10
Shelves	12
Storage Pans	11
Temperature Controls	8
Water Filter Cartridge	9

*Before
using
your
refrigerator*

Read this manual carefully. It is intended to help you operate and maintain your new refrigerator properly.

Keep it handy for answers to your questions.

If you don't understand something or need more help, there is a list of toll-free consumer service numbers included in the back section of this manual.

OR

Visit our Website at: monogram.com

Write down the model & serial numbers

You'll see them on a label inside the fresh food compartment under the storage drawers on the right side.

Before sending in the Product Registration card, please write these numbers here:

Model Number

Serial Number

Use these numbers in any correspondence or service calls concerning your refrigerator.

If you received a damaged refrigerator

Immediately contact the dealer (or builder) that sold you the refrigerator.

Save time & money

Before you request service, check the Problem Solver in the back of this manual.

It lists causes of minor operating problems that you can correct yourself.

If you need service

To obtain service, see the Consumer Services page in the back of this manual.

We're proud of our service and want you to be pleased. If for some reason you are not happy with the service you receive, here are steps to follow for further help.

For customers in the USA:

FIRST, contact the people who serviced your appliance. Explain why you are not pleased. In most cases, this will solve the problem.

NEXT, if you are still not pleased, write all the details—including your phone number—to:

Manager, Customer Relations
GE Appliances
Appliance Park
Louisville, KY 40225

For customers in Canada:

FIRST, contact the people who serviced your appliance. Explain why you are not pleased. In most cases, this will solve the problem.

NEXT, if you are still not pleased, write all the details—including your phone number to:

Manager, Consumer Relations
Mabe Canada Inc.
1 Factory Lane, Suite 310
Moncton, N.B. E1C 9M3

IMPORTANT SAFETY INSTRUCTIONS

SAFETY



GE Appliances Website

For more information on your refrigerator's operation, visit www.GEAppliances.com or call 800.GECARES (800.432.2737). In Canada visit GEAppliances.ca or call 800.561.3344.

REFRIGERATOR SAFETY INFORMATION

! This is the safety alert symbol. This symbol alerts you to potential hazards that can kill or hurt you and others. All safety messages will follow the safety alert symbol and the word "DANGER", "WARNING", or "CAUTION". These words are defined as:

- !** **DANGER** Indicates a hazardous situation which, if not avoided, **will** result in death or serious injury.
- !** **WARNING** Indicates a hazardous situation which, if not avoided, **could** result in death or serious injury.
- !** **CAUTION** Indicates a hazardous situation which, if not avoided, **could** result in minor or moderate injury.

IMPORTANT SAFETY INSTRUCTIONS

! **WARNING** To reduce the risk of fire, explosion, electric shock, or injury when using your refrigerator, follow these basic safety precautions:

- This refrigerator must be properly installed and located in accordance with the Installation Instructions before it is used.
 - Replace all parts and panels before operating.
 - Do not store or use gasoline or other flammable vapors and liquids in the vicinity of this or any other appliance.
 - Because of potential safety hazards under certain conditions, we strongly recommend against the use of an extension cord. However, if you must use an extension cord, it is absolutely necessary that it be a UL-listed (in the United States) or a CSA certified (in Canada), 3-wire grounding type appliance extension cord having a grounding type plug and outlet and that the electrical rating of the cord be 15 amperes (minimum) and 120 volts.
 - To prevent suffocation and entrapment hazards to children, remove the fresh food and freezer doors from any refrigerator before disposing of it or discontinuing its use.
 - Do not allow children to climb, stand or hang on the door handles or the shelves in the refrigerator. They could seriously injure themselves.
 - Unplug the refrigerator :
 - To discontinue power to the refrigerator. It cannot be turned off by any setting on the control panel.
 - To clean, replace a burned out light bulb, or make repairs.
- Note:** Repairs must be performed by a qualified Service Professional.

State of California Proposition 65 Warnings:

! **WARNING** This product contains one or more chemicals known to the State of California to cause cancer and birth defects or other reproductive harm.

IMPORTANT SAFETY INSTRUCTIONS

! **CAUTION** To reduce the risk of injury when using your refrigerator, follow these basic precautions.

- In refrigerators with automatic ice makers, avoid contact with the moving parts of the ejector mechanism, or with the heating element that releases the cubes. Do not place fingers or hands on the automatic ice making mechanism while the refrigerator is plugged in.
- Do not clean glass shelves or covers with warm water when they are cold. Glass shelves and covers may break if exposed to sudden temperature changes or impact, such as bumping or dropping. Tempered glass is designed to shatter into many small pieces if it breaks.
- Keep fingers out of the "pinch point" areas; clearances between the doors and between the doors and cabinet are necessarily small. Be careful closing doors when children are in the area.
- Do not touch the cold surfaces in the freezer compartment when hands are damp or wet, skin may stick to these extremely cold surfaces.
- Do not refreeze frozen foods which have thawed completely.

INSTRUCTIONS IMPORTANTES DE SÉCURITÉ

SÉCURITÉ



Site Internet d'Électroménagers GE

Pour de plus amples informations sur le fonctionnement de votre réfrigérateur, consultez le site www.electromenagersge.ca ou composez le 800.561.3344.

CONSIGNES DE SÉCURITÉ POUR LE RÉFRIGÉRATEUR

! Ce symbole représente une alerte de sécurité. Ce symbole vous avise de dangers possibles pouvant causer la mort, des blessures ou autres. Tous les messages de sécurité seront précédés du symbole d'alerte de sécurité ainsi que des mots « DANGER », « AVERTISSEMENT » ou « MISE EN GARDE ». Ces messages sont les suivants :

! DANGER

Signale une situation qui présente un danger imminent et qui, si elle n'est pas évitée, entraînera des blessures graves, voire la mort.

! AVERTISSEMENT

Signale une situation qui présente un danger imminent et qui, si elle n'est pas évitée, peut entraîner des blessures graves, voire la mort.

! MISE EN GARDE

Signale une situation qui présente un danger imminent et qui, si elle n'est pas évitée, peut entraîner des blessures mineures ou graves.

IMPORTANTES CONSIGNES DE SÉCURITÉ

! AVERTISSEMENT

Pour réduire le risque d'incendie, d'explosion, de choc électrique ou de blessures lorsque vous utilisez votre réfrigérateur, veuillez suivre ces consignes de sécurité :

- Vous devez bien installer et placer votre réfrigérateur, conformément aux Instructions d'installation avant de l'utiliser.
 - Remettez toutes les pièces et panneaux en place avant d'utiliser l'appareil.
 - Ne conservez jamais ou n'utilisez jamais d'essence ou d'autres liquides ou gaz inflammables à proximité de votre réfrigérateur ou de tout autre appareil électroménager.
 - Nous déconseillons fortement l'utilisation d'une rallonge à cause des risques potentiels dans certaines conditions. Cependant, si l'utilisation d'un cordon prolongateur est nécessaire, ce dernier doit obligatoirement être homologué UL (aux USA) ou CSA (au Canada), à trois brins avec mise à la terre pour appareil électroménager et doit être équipé d'une fiche et d'une prise femelle avec terre. Les caractéristiques électriques du cordon prolongateur doivent être de 15 ampères (minimum) et de 120 volts.
 - Pour éviter les risques d'asphyxie et d'enfermement pour les enfants. Démontez les portes du congélateur et du compartiment de réfrigération avant de le mettre au rebut ou d'interrompre son utilisation.
 - Ne permettez jamais aux enfants de grimper, de monter, de se tenir ou de se pendre aux étagères de votre réfrigérateur. Ils peuvent endommager le réfrigérateur et se blesser sérieusement.
 - Débranchez votre réfrigérateur :
 - L'alimentation électrique du réfrigérateur ne peut pas être coupée par l'intermédiaire du panneau de commande.
 - Débranchez votre réfrigérateur avant de le nettoyer, Avant de remplacer une ampoule grillée, et de le réparer.
- NOTE :** Nous vous recommandons fortement de faire accomplir tout service par un technicien qualifié.

Avertissements de la Proposition 65 de l'État de la Californie :

! AVERTISSEMENT

Ce produit contient une ou plusieurs substances chimiques reconnues par l'État de Californie pour causer le cancer et des anomalies congénitales ou d'autres problèmes liés à la reproduction.

IMPORTANTES CONSIGNES DE SÉCURITÉ

! MISE EN GARDE

Pour réduire le risque de blessures lorsque vous utilisez votre réfrigérateur, veuillez suivre ces consignes de sécurité :

- Dans les réfrigérateurs qui ont des machines à glaçons, évitez tout contact avec les éléments mobiles du mécanisme d'éjection ou avec l'élément chauffant situé à la partie inférieure de la machine à glaçons. Ne mettez jamais vos doigts ou vos mains sur le mécanisme de fabrication automatique de glaçons quand le réfrigérateur est branché.
- Ne nettoyez pas les clayettes ou les couvercles en verre avec de l'eau tiède quand ceux-ci sont froids. Les clayettes et couvercles en verre peuvent se casser s'ils sont exposés à des changements soudains de température ou si vous les cognez ou les faites tomber. Le verre trempé est conçu pour se briser en petits morceaux en cas de casse.
- Ne laissez jamais vos doigts dans des endroits où ils risquent d'être pincés. L'écartement entre les portes et l'armoire est nécessairement petit. Faites attention de fermer les portes quand des enfants se trouvent à proximité.
- Ne touchez jamais les surfaces froides dans le compartiment congélation quand vos mains sont humides ou mouillées. Votre peau peut coller à ces surfaces extrêmement froides.
- Ne recongelez pas les aliments surgelés qui ont complètement dégelé.

IMPORTANT SAFETY INSTRUCTIONS

SAFETY (CONT.)

CONNECTING ELECTRICITY

WARNING **Electrical Shock Hazard.**

Plug into a grounded 3-prong outlet

Do not remove the ground prong

Do not use an adapter

Failure to follow these instructions can result in death, fire, or electrical shock.



Do not, under any circumstances, cut or remove the third (ground) prong from the power cord. For personal safety, this appliance must be properly grounded.

The power cord of this appliance is equipped with a 3-prong (grounding) plug which mates with a standard 3-prong (grounding) wall outlet to minimize the possibility of electric shock hazard from this appliance.

Have the wall outlet and circuit checked by a qualified electrician to make sure the outlet is properly grounded.

Where a standard 2-prong wall outlet is encountered, it is your personal responsibility and obligation to have it replaced with a properly grounded 3-prong wall outlet. Do not use an adapter.

The refrigerator should always be plugged into its own individual electrical outlet which has a voltage rating that

matches the rating plate. This provides the best performance and also prevents overloading house wiring circuits which could cause a fire hazard from overheated wires.

Never unplug your refrigerator by pulling on the power cord. Always grip plug firmly and pull straight out from the outlet.

Repair or replace immediately all power cords that have become frayed or otherwise damaged. Do not use a cord that shows cracks or abrasion damage along its length or at either end.

When moving the refrigerator away from the wall, be careful not to roll over or damage the power cord.



USE OF EXTENSION CORDS

Because of potential safety hazards under certain conditions, we strongly recommend against the use of an extension cord.

However, if you must use an extension cord, it is absolutely necessary that it be a UL-listed (in the United States) or a CSA-listed (in Canada), 3-wire grounding type appliance extension cord having a grounding type plug and outlet and that the electrical rating of the cord be 15 amperes (minimum) and 120 volts.

PROPER DISPOSAL OF YOUR OLD REFRIGERATOR

WARNING **Suffocation and child entrapment hazard.**

Remove fresh-food and freezer doors from the refrigerator, prior to disposal. Failure to do so can result in child entrapment which can lead to death or brain damage.

IMPORTANT: Child entrapment and suffocation are not problems of the past. Junked or abandoned refrigerators are still dangerous even if they will sit for "just a few days." If you are getting rid of your old refrigerator, please follow the instructions below to help prevent accidents.

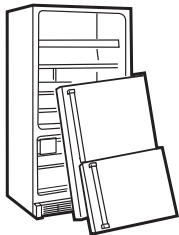

Before You Throw Away Your Old Refrigerator or Freezer:

- Take off the fresh food and freezer doors.
- Leave the shelves in place so that children may not easily climb inside.

Refrigerants

All refrigeration products contain refrigerants, which under federal law must be removed prior to product disposal. If you are getting rid of an old refrigeration product, check with the company handling the disposal about what to do.



READ AND FOLLOW THIS SAFETY INFORMATION CAREFULLY.
SAVE THESE INSTRUCTIONS

INSTRUCTIONS IMPORTANTES DE SÉCURITÉ

SÉCURITÉ (CONT.)

BRANCHEMENTS ÉLECTRIQUES



AVERTISSEMENT



Risque de choc électrique.

Le non-respect de ces instructions peut entraîner des risques d'incendies, des chocs électriques ou la mort.

Branchez l'appareil dans une prise triple avec terre.

Ne retirez pas la broche de terre.

N'utilisez pas d'adaptateur.

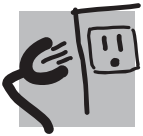

Ne coupez pas ou n'enlevez pas, sous aucun prétexte, la troisième broche de mise à la terre du cordon d'alimentation. Pour des raisons de sécurité, cet appareil doit être correctement mis à la terre.

Le cordon d'alimentation de cet appareil est équipé d'une fiche à trois broches (pour une mise à la terre) qui s'adapte à la prise de courant standard à 3 broches (pour une mise à la terre) pour minimiser les risques de chocs électriques par cet appareil.

Faites vérifier la prise murale et le circuit électrique par un électricien qualifié pour s'assurer que le système est correctement mis à la terre.

Dans le cas d'une prise biphasée, l'installateur a la responsabilité et l'obligation de la remplacer par une prise triphasée correctement mise à la terre. N'utilisez pas d'adaptateur.

Le réfrigérateur doit toujours être branché à sa propre prise électrique d'une tension nominale correspondant à celle indiquée sur sa plaque signalétique.

Une alimentation électrique à 115 volts CA, 60 Hz, avec un fusible

de 15 ou 20 ampères et une mise à la terre est nécessaire. Ceci permet d'obtenir un meilleur rendement et évite de surcharger les circuits électriques du domicile qui risque d'occasionner un incendie en surchauffant.

Ne débranchez jamais le réfrigérateur en tirant sur le cordon d'alimentation. Prenez toujours fermement la fiche en main et tirez pour la sortir de la prise.

Réparez ou remplacez immédiatement tout cordon électrique usé ou endommagé. N'utilisez pas un cordon fissuré ou présentant des dommages dus aux frottements soit sur sa longueur ou aux extrémités.

Lorsque vous éloignez votre réfrigérateur du mur, faites attention à ne pas le faire rouler sur le cordon d'alimentation afin de ne pas l'endommager.

UTILISATION DE RALLONGES ÉLECTRIQUES



Nous vous recommandons fortement de ne pas utiliser de rallonge électrique, à cause d'un danger de risques possibles de sécurité dans certaines conditions.

Cependant, si vous devez absolument utiliser un cordon rallonge électrique, il est absolument requis que vous utilisiez un cordon rallonge trifilaire, avec mise à la terre, certifié UL (aux États-Unis) ou ACNOR (au Canada), avec prise et fiche à trois conducteurs, et à notation électrique de 15 ampères (minimum) et 120 volts.

MISE AU REBUT APPROPRIÉE DE VOTRE ANCIEN RÉFRIGÉRATEUR



AVERTISSEMENT

Un enfant risque de suffoquer ou d'y être emprisonné.

Démontez les portes du compartiment de réfrigération et du compartiment de congélation du réfrigérateur, avant mettre celui-ci au rebut. Le non-respect de cette recommandation peut entraîner l'enfermement d'un enfant qui peut entraîner la mort ou des lésions cérébrales.

IMPORTANT:

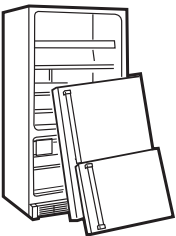

Les enfants pris au piège ou morts d'asphyxie sont toujours d'actualité. Les réfrigérateurs jetés ou abandonnés restent dangereux même si vous ne les laissez au rebut que pour « quelques jours ». Si vous voulez jeter votre ancien réfrigérateur, suivez les instructions suivantes pour empêcher les accidents.

Avant de jeter votre ancien réfrigérateur ou congélateur:

- Démontez les portes du compartiment de réfrigération et du compartiment de congélation.
- Laissez les clayettes en place, pour éviter que des enfants puissent facilement grimper dans votre réfrigérateur.

Fluides frigorigènes

Les appareils réfrigérants contiennent des fluides frigorigènes qui conformément à la législation fédérale doivent être retirés avant la mise au rebut de l'appareil. Si vous mettez au rebut un ancien réfrigérateur contenant des fluides frigorigènes, vérifiez la procédure à suivre auprès de la compagnie responsable de l'élimination.



LISEZ ET SUIVEZ SOIGNEUSEMENT CES MESURES DE SÉCURITÉ.

Temperature controls



Preset Settings: Allow 24 hours to reach these preset temperatures.

The temperature display shows the actual temperature of the freezer and fresh food compartments. The actual temperature will vary from the set temperature based on factors such as frequency of door opening, amount of food, defrost cycling and room temperature.

NOTE: Frequent door openings or door left open for periods of time may increase the internal temperature of the freezer and fresh food compartments temporarily.

To turn off the cooling system in both the freezer and fresh food compartments, press either (+) pad until both displays show **OFF**.

To turn the cooling system on, press either (-) pad. The preset temperatures of 0°F and 37°F will appear in the display.

To check the current temperature setting for the fresh food or freezer compartment, press the (+) or (-) pad once. After 5 seconds, the display will return to the actual temperature.

To change the temperature settings, press the (+) or (-) pads to desired temperature set point for fresh food and freezer separately. Allow 24 hours for the refrigerator to reach the temperature you have set.

Temperature Ranges

	Low	High
Fresh Food	34°F 1°C	42°F 5°C
Freezer	-6°F -21°C	+4°F -15°C

NOTE:

Setting the controls to **OFF** stops cooling, but **does not** shut off electrical power to the refrigerator.

Changing display temperatures from °F to °C

To change the temperature display between Fahrenheit and Celsius, press the **Temp Display °C/°F**.



Door alarm

To turn the Door Alarm feature on, press the pad once. The **ACTIVE** light will come on. To turn it off, press the pad again.

When the **DOOR ALARM** is active, the alarm will flash and beep if you keep the door open for more than 2 minutes.



Water filter cartridge

Water filter cartridge

The water filter cartridge is located behind the top access panel.

When to replace the filter

There is a replacement indicator light for the water filter cartridge on the temperature control panel. This light will turn orange to tell you that you need to replace the filter soon.

The filter cartridge should be replaced when the replacement indicator light turns red or if the flow of water to the dispenser or ice maker decreases.

Removing the filter cartridge

If you are replacing the cartridge, first remove the old one by slowly turning it to the left. **Do not** pull down on the cartridge. A small amount of water may drip down.

NOTE: To reduce the risk associated with property damage due to water leakage, read and follow instructions before installation and use of this system. Installation and use **MUST** comply with all state and local plumbing codes.

Installing the filter cartridge

1 Fill the replacement cartridge with water from the tap to allow for better flow immediately after installation.

2 Line up the arrow on the cartridge and the cartridge holder. Place the top of the new cartridge up inside the holder. **Do not** push it up into the holder.

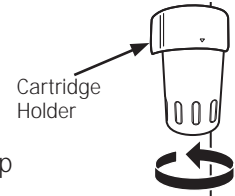

3 Slowly turn it to the right until the filter cartridge stops. **DO NOT OVERTIGHTEN.** As you turn the cartridge, it will automatically raise itself into position. The cartridge will move about 1/2 turn.

4 Press and hold the **RESET WATER FILTER** pad on the temperature control panel for three seconds to clear the red or amber light.

NOTE: A newly installed water filter cartridge may cause water to spurt into the ice maker.

Filter bypass plug

You must use the filter bypass plug when a replacement filter cartridge is not available. The ice maker will not operate without the filter or filter bypass plug.

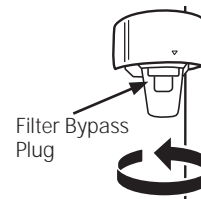

SmartWater

For the maximum benefit of your filtration system, GE Appliances recommends the use of GE Appliances-branded filters only. Using GE Appliances-branded filters in GE Appliances, Hotpoint® and Monogram refrigerators provides optimal performance and reliability. GE Appliances filters meet rigorous industry NSF standards for safety and quality that are important for products that are filtering your water. GE Appliances has not qualified non-GE Appliances-branded filters for use in GE Appliances and Hotpoint refrigerators and there is no assurance that non-GE Appliances-branded filters meet GE Appliances standards for quality, performance and reliability.

If you have questions, or to order additional filter cartridges, visit our website at www.gewaterfilters.com or call GE Appliances Parts and Accessories, 877.959.8688.

Customers in Canada should consult the yellow pages for the nearest Camco Service Center.

Automatic Icemaker

⚠ CAUTION

Avoid contact with the moving parts of the ejector mechanism, or with the heating element (located on the bottom of the ice maker) that releases the cubes. Do not place fingers or hands on the automatic ice making mechanism while the refrigerator is plugged in.

⚠ MISE EN GARDE

Évitez tout contact avec les pièces mobiles du mécanisme d'éjection ou l'élément chauffant (situé dans le bas de la machine à glaçons) qui libère les cubes. Ne placez pas les doigts ou les mains sur le mécanisme de production de glace automatique lorsque le réfrigérateur est branché dans la prise électrique.

A newly-installed refrigerator may take 12–24 hours to begin making ice.

The icemaker will produce seven cubes per cycle—approximately 15 cycles in a 24-hour period, depending on freezer compartment temperature, room temperature, number of door openings, and other use conditions.

If the refrigerator is operated before the water connection is made to the icemaker, set the power switch to **OFF**.

When the refrigerator has been connected to the water supply, set the power switch to **ON**.

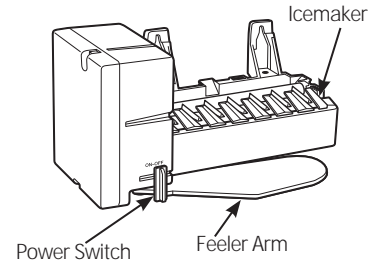

Throw away the first full bucket of ice to allow the water line to clear.

Be sure nothing interferes with the sweep of the feeler arm.

When the bin fills to the level of the feeler arm, the icemaker will stop producing ice.

It is normal for several cubes to be joined together.

If ice is not used frequently, old ice cubes will become cloudy, taste stale and shrink.

If ice cubes get stuck in the icemaker, set the power switch to **OFF** and remove the cubes. Set the power switch to **ON** to restart the icemaker.

The ice bucket is conveniently located in the upper freezer basket. Occasionally ice cubes may spill out of the bucket if the basket is opened too quickly.

NOTE: Ice maker works best between 40-120 psi home water pressure.

Sabbath Mode Product Kit

(available at extra cost)



COMPLIANT

(with kit installed and icemaker OFF)

The Sabbath Mode Product Kit was designed for use on the Jewish Sabbath and Holidays. The Sabbath Mode feature makes it possible for observant Jews to refrigerate and freezer food during the duration of the holiday.

The Sabbath Mode feature can be set to override typical reactions to actions in your refrigerator. While in the Sabbath Mode, your refrigerator will still operate normally. However, the refrigerator will not respond to your actions.

While in the Sabbath Mode, you may notice the fan running when the door is opened; however, this is not a result of your actions. The fan will operate at random times. The defrost heater will continue to defrost the refrigerator and freezer and will be activated on a timer. The defrost heater will not defrost as a result of door openings or any consumer actions.

ON/OFF—To activate, raise the top grille panel, set the Sabbath Mode switch to the **ON** position. A green LED light will be visible below the Sabbath Mode Kit switch. The green light may not be visible with the top grille panel closed. If you are not sure if the unit is in Sabbath Mode, raise the grille panel and see if the green light is on.

DISPLAYS, ALARMS and LIGHTS—The main temperature control, door alarms and lights will be disabled.

ICEMAKER—The icemaker will continue to operate. The icemaker can be disabled by setting the icemaker power switch to the **OFF** position (see Automatic Icemaker). To obtain ice, open the freezer door and remove the cubed ice from the ice bin.

This Sabbath Mode Product Kit can be purchased from your local appliance dealer. The ZSAB1 Kit is designed for use with Monogram Built-In Bottom-Freezer models manufactured after April 2004. To locate your nearest dealer, visit our web site monogram.com or call 1.800.626.2005. In Canada, call 1.800.561.3344. Order Kit # ZSAB1.

NOTE: The Sabbath Mode Product Kit must be installed by a qualified service technician.

Storage Pans

Bottom Freezer Refrigerator

Sealed snack pans

The sealed snack pans retain high humidity for the convenient storage of lunch meats and cheese, hors d'oeuvres, spreads and snacks.

Make sure the pans are closed completely to maintain the correct humidity level.

Excess water that may accumulate on the bottom of the drawers should be emptied and the drawers wiped dry.



These pans must be fully closed before closing the fresh food compartment door.

Adjustable humidity pans

These drawers have individual, adjustable humidity controls that let you control the amount of cold air entering the drawers.

Make sure the drawers are closed completely to maintain the correct humidity level.

Slide the control all the way to the High setting and the drawer provides **higher humidity levels** recommended for most leafy vegetables.

Slide the control all the way to the Low setting and the drawer provides **lower humidity levels** recommended for most fruits.

Excess water that may accumulate on the bottom of the drawers should be emptied and the drawers wiped dry.

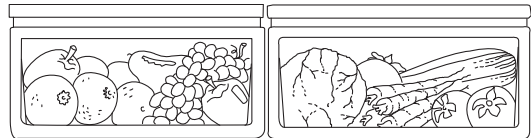

These pans must be fully closed before closing the fresh food compartment door.

Pan removal

To remove a pan, pull it out and lift the front up and out of the wire holder. Lift the back up and out.

To replace a pan, place the back of the pan in the wire holder, making sure the indentations at the back of the pan fit into the back of the wire holder. Then lower the front of the pan into the wire holder. Press firmly on the top of the pan until it snaps into place.

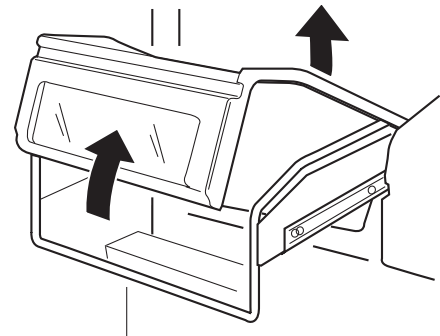

High humidity storage

Storing unwrapped foods in a high humidity environment keeps foods fresh by retaining the natural moisture content of foods such as:

- Artichokes
- Asparagus
- Beets, topped
- Blueberries
- Carrots
- Celery
- Cherries
- Corn
- Cucumbers
- Currants
- Greens, leafy
- Lettuce
- Parsley
- Peas, green
- Radishes
- Rhubarb
- Spinach
- Tomatoes, ripe

As in any refrigerated storage area, it is recommended that foods with strong odors be stored wrapped—foods such as:

- Broccoli
- Brussels sprouts
- Cabbage
- Cauliflower
- Green onions
- Parsnips
- Turnips

Low humidity storage

Lower humidity storage should be used for items such as:

- Apples
- Apricots
- Grapes
- Mushrooms
- Nectarines
- Oranges
- Papayas
- Peaches
- Pears
- Pomegranates
- Mangoes
- Raspberries
- Squash, summer
- Strawberries
- Tangerines

Adjustable shelves in the fresh food compartment

Tempered glass shelves in the fresh food compartment enable you to make efficient shelf arrangements to fit your family's food storage needs.

To remove shelves: Tilt shelf up at front, then lift it up and out of tracks on rear wall of refrigerator.

To replace shelves: Select desired shelf height. With shelf front raised slightly, engage top lugs in tracks at rear of cabinet. Then lower front of shelf until it locks into position.

CAUTION

Do not clean glass shelves or covers with warm water when they are cold. Glass shelves and covers may break if exposed to sudden temperature changes or impact, such as bumping or dropping. Tempered glass is designed to shatter into many small pieces if it breaks.

MISE EN GARDE

Ne nettoyez pas les clayettes ou les couvercles en verre avec de l'eau tiède quand ceux-ci sont froids. Les clayettes et couvercles en verre peuvent se casser s'ils sont exposés à des changements soudains de température ou si vous les cognez ou les faites tomber. Le verre trempé est conçu pour se briser en petits morceaux en cas de casse.

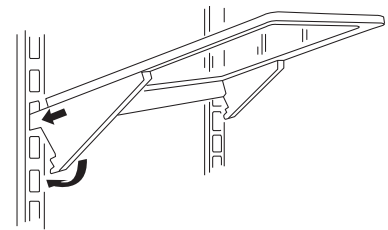
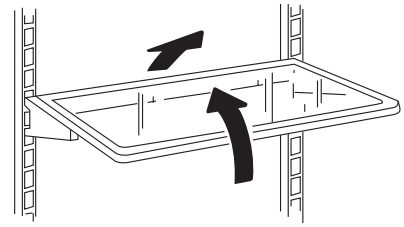

Door bins

Some door bins are adjustable and can be moved up and down to meet your storage needs.

NOTE: The deeper door bins must be placed at the bottom of the door only.

To remove: Lift the bin up and slide it toward you.

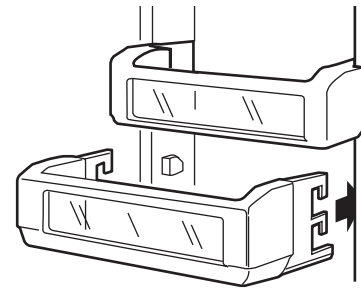

Freezer drawer with basket

Inside the freezer drawer is a wire slide-out freezer basket.

This basket can be pushed back so items on the bottom of the freezer drawer can be reached.

To remove the basket:

- 1 Open the freezer drawer.
- 2 Lift up the back of the basket, then slide the basket back until it clears the front hooks.

Ensure that the freezer drawer is fully closed after each opening to maintain normal operating performance.

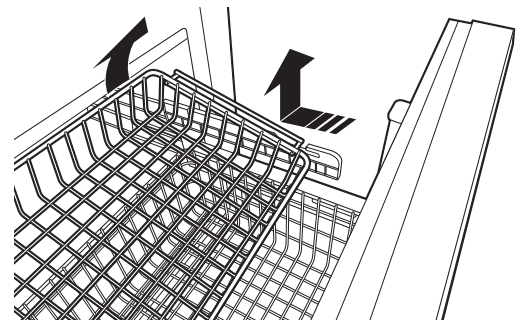

To remove basket

Cleaning outside

The door handles and trim. Clean with a cloth dampened with soapy water. Dry with a soft cloth.

Keep the outside clean. Wipe with a clean cloth lightly dampened with mild liquid dish detergent. Dry with a clean, soft cloth.

Do not wipe the refrigerator with a soiled dish cloth or wet towel. These may leave a residue that can damage the finish. Do not use scouring pads, powdered cleaners, bleach or cleaners containing bleach because these products can scratch and damage the finish.

Stainless steel—Regularly clean and polish the stainless steel door panels and handles (on some models) with a commercially available stainless steel cleaner such as *Stainless Steel Magic™* to preserve and protect the fine finish. *Stainless Steel Magic* and the Monogram polishing cloth are available through GE Appliances Parts and Accessories, 877.959.8688, or monogram.com. For *Stainless Steel Magic*, order part number WX10X15. For Monogram polishing cloth, order part number WX72X10001.

Do not use appliance wax or polish on the stainless steel.

Cleaning inside

To help prevent odors, leave an open box of baking soda in the refrigerator and freezer compartments.

Turn off power at the circuit breaker or fuse box before cleaning. If this is not practical, wring excess moisture out of sponge or cloth when cleaning around switches, lights or controls.

Use warm water and baking soda solution—about a tablespoon (15 ml) of baking soda to a quart (1 liter) of water. This both cleans and neutralizes odors. Thoroughly rinse and wipe dry.

Other parts of the refrigerator—including door gaskets, meat and vegetable drawers, ice storage bin and all plastic parts—can be cleaned the same way. After cleaning the door gaskets, apply a thin layer of petroleum jelly to the door gaskets sealing surface on the hinge side. This helps keep the gaskets from sticking and bending out of shape.

Avoid cleaning cold glass shelves with hot water because the extreme temperature difference may cause them to break. Handle glass shelves carefully. Rough handling of tempered glass can cause it to shatter.

Do not wash any plastic refrigerator parts in the dishwasher.

Preparing for vacation

For long vacations or absences, remove food and shut off power to the refrigerator at the fuse box or circuit breaker. Clean the interior with a baking soda solution of one tablespoon (15 ml) of baking soda to one quart (1 liter) of water. Leave the doors open.

For shorter vacations, remove perishable foods and leave controls at regular settings. However, if the room temperature is expected to drop below 60°F (16°C), follow the same instructions as for long vacations.

Set the icemaker power switch to the **Off** position and shut off the water supply to the refrigerator.

Using the Master Light switch

This feature turns off the lights in the fresh food and freezer compartments.

The switch is located behind the grille panel at the top of the refrigerator. Lift up the panel to access the switch.

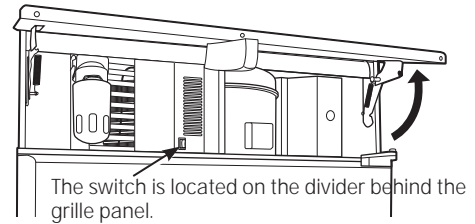

Light bulb replacement in the fresh food compartment

Important: Turning the temperature control to OFF does not remove power to the light circuit.

There are four light bulbs in the top of the fresh food compartment.

To replace the bulbs:

- 1 Set the Master Light switch in the OFF position to turn off the lights. See *Using the Master Light switch*.
- 2 Remove the light shield by placing your fingers in the openings at the back of the shield. Then, pull the shield toward you and swing the back of the shield down.
- 3 Replace with the same size bulb (40 watt max.).
- 4 Reinstall the shield and reset the Master Light switch to the ON position.

Replacement 40-watt bulbs can be purchased at your local general retail store, through GE Appliances Parts and Accessories, 877.959.8688, or at monogram.com. Order part # 40A15.

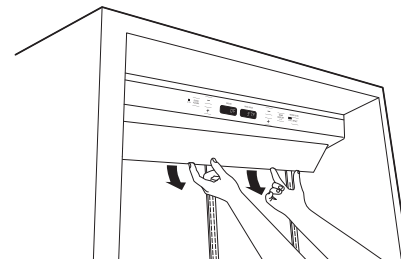
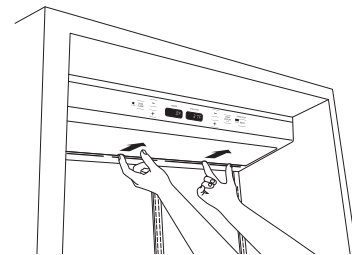

Light bulb replacement in the freezer compartment

To replace a bulb:

- 1 Set the Master Light switch in the OFF position to turn off the lights. See *Using the Master Light switch*.
- 2 Remove the freezer light shield by removing the two screws with a Phillips screwdriver.
- 3 Replace with the same size bulb (40 watt max.).
- 4 Reinstall the shield and reset the Master Light switch to the ON position.

Replacement 40-watt bulbs can be purchased at your local general retail store, through GE Appliances Parts and Accessories, 877.959.8688, or at monogram.com. Order part # 40A15.

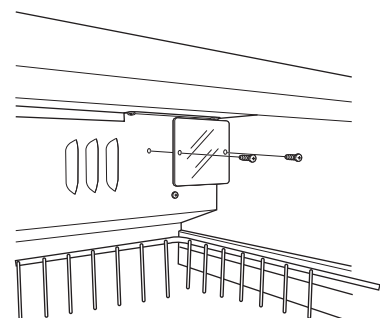

Questions?

Use this
problem
solver!

PROBLEM	POSSIBLE CAUSE
REFRIGERATOR DOES NOT OPERATE	<ul style="list-style-type: none"> • May be in defrost cycle when compressor does not operate for about 30 minutes. • Temperature control in the OFF position. • If interior light is not on, refrigerator may not be plugged in at wall outlet. • The fuse is blown/circuit breaker is tripped. Replace fuse or reset the breaker. • The Sabbath Kit may be installed and operating. Turn off the Sabbath Mode device.
<p>MOTOR OPERATES FOR LONG PERIODS OR CYCLES ON AND OFF FREQUENTLY</p> <p>(Modern refrigerators with more storage space and a larger freezer require more operating time. They start and stop often to maintain even temperatures.)</p>	<ul style="list-style-type: none"> • Normal when refrigerator is first plugged in. Wait 24 hours for the refrigerator to completely cool down. • The new variable speed compressor is designed to run for longer periods of time to optimize efficiency and noise. You may notice the compressor and/or fan speeds accelerate based upon door openings and/or increased food loads. • You may hear the fans spinning at high speeds. This happens when the refrigerator is first plugged in, when the doors are opened frequently or when a large amount of food is added to the refrigerator or freezer compartments. The fans are helping to maintain the correct temperatures. • Door left open or package holding door open. • If either door is open for over 3 minutes, you may hear the fans come on in order to cool the light. • Hot weather or frequent door openings. This is normal. • Temperature controls set at the coldest setting. See <i>Temperature Controls</i>.
THUMPING SOUND WHEN DOOR IS CLOSED	<ul style="list-style-type: none"> • This is a normal operating sound. • The mechanism that closes the door makes a slight thumping sound as it passes over its lever point, at approximately 80 degrees. • Closing the door slowly will minimize the sound.
OPERATING SOUNDS	<ul style="list-style-type: none"> • The variable speed compressor changes speeds and sounds may vary. • Normal fan air flow—one fan blows cold air through the fresh food and freezer compartments—another fan cools the compressor motor. • The fans change speeds in order to provide optimal cooling and energy savings. • These NORMAL sounds will also be heard from time to time: <ul style="list-style-type: none"> – You may hear a whooshing or gurgling sound when the doors close. This is due to pressure equalizing within the refrigerator. – A water dripping noise may occur during the defrost cycle as ice melts from the evaporator and flows into the drain pan. – The flow of refrigerant through the freezer cooling coils may make a gurgling noise like boiling water. – Water dropping on the defrost heater can cause a sizzling, popping or buzzing sound during the defrost cycle. – You may hear cracking or popping sounds when the refrigerator is first plugged in or during/after the defrost cycle. This happens as the refrigerator cools to the correct temperature. – Electronic dampers click open and closed to provide optimal cooling and energy savings. – The compressor may cause a clicking or chirping sound when attempting to restart (this could take up to 5 minutes). – The electronic control board may cause a clicking sound when relays activate to control refrigerator components. – Ice cubes dropping into the bin. – The icemaker water valve will buzz and water will run in tubes when the icemaker fills with water.

The Problem Solver

Bottom Freezer Refrigerator

Questions?
Use this
problem
solver!

PROBLEM	POSSIBLE CAUSE
DOOR NOT CLOSING PROPERLY	<ul style="list-style-type: none"> • Package holding door open. • Check the door gasket; it may be out of position. • Refrigerator not level. See <i>Installation Instructions</i>.
VIBRATION OR RATTLING (Slight vibration is normal.)	<ul style="list-style-type: none"> • Refrigerator may not be properly installed.
FRESH FOOD FREEZER OR COMPARTMENT TOO WARM	<ul style="list-style-type: none"> • Temperature controls not set cold enough. See <i>Temperature Controls</i>. • Warm weather or frequent door openings. • Door left open for long time or freezer door left ajar. • Package may be holding door open.
FROST OR ICE CRYSTALS ON FROZEN FOOD (Frost within package is normal.)	<ul style="list-style-type: none"> • Door left open or package holding door open. • Frequent or long door openings. • Freezer door left ajar.
SLOW ICE CUBE FREEZING	<ul style="list-style-type: none"> • Door may have been left open or freezer door left ajar. • Temperature of freezer compartment too warm. • Package may be holding door open.
ICE CUBES HAVE ODOR/TASTE	<ul style="list-style-type: none"> • Old cubes need to be discarded. • Ice storage bin needs to be emptied and washed. • Unsealed packages in freezer compartment may be transmitting odor/taste to ice cubes. • Keep open box of baking soda in refrigerator; replace every 3 months. • Interior of refrigerator needs cleaning. See <i>Care and Cleaning</i>. • Poor-tasting incoming water. Replace water filter.
AUTOMATIC ICEMAKER DOES NOT WORK	<ul style="list-style-type: none"> • Icemaker power switch is in the Off position. • Water supply turned off, restricted or not connected. Call your installer for proper water supply line connection. • Water filter clogged. Replace the filter or use the filter bypass plug. • Freezer compartment too warm. • Piled up cubes in storage bin may cause icemaker to shut off too soon. Level cubes in bin. • Ice cubes stuck in icemaker. Turn off the icemaker, remove cubes and turn the icemaker back on.
MOISTURE FORMS ON OUTSIDE OF REFRIGERATOR	<ul style="list-style-type: none"> • Not unusual during periods of high humidity. Wipe surface dry. • Door left open or package holding door open. • Control humidity and temperature in the kitchen with air conditioning.
MOISTURE COLLECTS INSIDE	<ul style="list-style-type: none"> • In humid weather, air carries moisture into refrigerator when doors are opened. • Control humidity and temperature in the kitchen with air conditioning
REFRIGERATOR HAS ODOR	<ul style="list-style-type: none"> • Foods with strong odors should be tightly covered. • Check for spoiled food. • Interior needs cleaning. See <i>Care and Cleaning</i>. • Keep open box of baking soda in refrigerator; replace every 3 months. • Defrost water system beneath unit needs to be cleaned.
INTERIOR LIGHT DOES NOT WORK	<ul style="list-style-type: none"> • No power at outlet. • Light bulb needs replacing. See <i>Care and Cleaning</i>. • Master Light switch is in the OFF position. • The Sabbath Mode Kit may be installed and operating. Turn off the Sabbath Mode device.
SMALL OR HOLLOW CUBES	<ul style="list-style-type: none"> • Water filter clogged. Replace the filter or use the filter bypass plug. • Check for a connection to a Reverse Osmosis water system. If an RO is connected, remove the water filter and install the original bypass plug that came with the unit.
CLICKING SOUND WHEN FREEZER DRAWER IS OPENED OR CLOSED	<ul style="list-style-type: none"> • This unit is equipped with a hold shut feature, which can be heard when the drawer front is within 2" of the face of the cabinet.
FREEZER DRAWER NOT CLOSING PROPERLY	<ul style="list-style-type: none"> • Package holding drawer open. • Drawer hold -shut needs reset, open drawer fully and forcefully close

Performance Data Sheet

SmartWater™ Filtration System—GE MWF Cartridge

Performance Data Information

Capacity: 300 Gallons (1,135 Liters)

The concentration of the contaminants tested for this filter in water entering the system was reduced to a concentration less than or equal to the permissible limit for water leaving the system as specified in NSF/ANSI Standard 42 and Standard 53. System tested and certified by NSF International against NSF/ANSI Standard 42 and Standard 53.

Please see geappliances.com for complete listing of the contaminants tested and the amounts reduced

The following pharmaceutical reduction claims have not been certified by NSF International or the state of California. Claims tested and verified by independent laboratory:

Contaminant Reduction	Average Influent	NSF specified Challenge Concentration	Avg % Reduction	Average Product Water Concentration	Max Permissible Product Water Concentration	NSF Reduction Requirements	NSF Test Report
Atenolol	978 ng/L	N/A	99.5%	5.0 ng/L	N/A	N/A	J-00121587
Fluoxetine	907 ng/l	N/A	99.4%	5.4 ng/L	N/A	N/A	J-00121587
Ibuprofen	885 ng/L	N/A	94.1%	52.3 ng/L	N/A	N/A	J-00121588
Progesterone	1097 ng/L	N/A	99.5%	5.0 ng/L	N/A	N/A	J-00121589
Trimethoprim	415 ng/L	N/A	99.5%	2.0 ng/L	N/A	N/A	J-00121587

Application Guidelines/Water Supply Parameters

Service Flow	0.5 gpm (21.9 lpm)	Water Pressure	40-120 psi (2.8-8.2 bar)
Water Supply	Potable Water	Water Temperature	33°F-100°F (0.6°C-38°C)

It is essential that the manufacturer's recommended installation, maintenance and filter replacement requirements be carried out for the product to perform as advertised. See Installation Manual for Warranty information.

Note: While the testing was performed under standard laboratory conditions, actual performance may vary.

Replacement Cartridge: MWF. For estimated costs of replacement elements please call 1-800-626-2002 or visit our website at www.geapplianceparts.com.

⚠ WARNING

To reduce the risk associated with ingestion of contaminants:

- Do not use with water that is microbiologically unsafe or of unknown quality without adequate disinfection before and after the system. Systems certified for cyst reduction may be used on disinfected water that may contain filterable cysts. EPA Establishment Number 10350-MN-005.

For conditions of use, health claims certified by the California Department of Public Health, and replacements, see performance data sheet. California Department of Public Health Certification #05-1698. The contaminants or other substances removed or reduced by this water filter are not necessarily in all users' water.

NOTICE

To reduce the risk associated with property damage due to water leakage:

- Read and follow use instructions before installation and use of this system.
- Installation and use **MUST** comply with all state and local plumbing codes.
- Do not install if water pressure exceeds 120 psi (8.2 bar). If your water pressure exceeds 80 psi, you **must** install a pressure-limiting valve. Contact a plumbing professional if you are uncertain how to check your water pressure.
- Do not install where water hammer conditions may occur. If water hammer conditions exist you **must** install a water hammer arrester. Contact a plumbing professional if you are uncertain how to check for this condition.
- Do not install on hot water supply lines. The maximum operating water temperature of this filter system is 100° F (38° C).
- Protect filter from freezing. Drain filter when temperatures drop below 33°F (0.6°C).
- The disposable filter cartridge **must** be replaced every 6 months at the rated capacity, or sooner if a noticeable reduction in flow rate occurs.



Tested and certified by NSF International against NSF/ANSI Standard 42 and Standard 53 in model GE MWF for the reduction of the claims specified on the performance data sheet.

With the purchase of your new Monogram appliance, receive the assurance that if you ever need information or assistance from GE Appliances, we'll be there. All you have to do is call—toll-free!

GE Appliances Answer Center®

***In the USA:
800.432.2737***

Whatever your question about any Monogram major appliance, GE Appliances Answer Center® information service is available to help. Your call—and your question—will be answered promptly and courteously. Call the GE Appliances Answer Center® Monday to Friday, 8 a.m. to 10 p.m. EST, and Saturday, 8 a.m. to 7 p.m. EST.

OR

Visit our Website at: monogram.com

In Canada, call 1.800.561.3344.

In-Home Repair Service

***In the USA:
800.432.2737***

***In Canada:
1.800.561.3344***

A GE Appliances consumer service professional will provide expert repair service, scheduled at a time that's convenient for you. To schedule service, call Monday to Friday, 7 a.m. to 10 p.m. EST, or Saturday and Sunday, 8 a.m. to 6 p.m. EST. Many GE Appliances Consumer Service company-operated locations offer you service today or tomorrow, or at your convenience. Our factory-trained technicians know your appliance inside and out—so most repairs can be handled in just one visit.

In Canada: Monday through Friday, 7 a.m. to 8 p.m., and Saturday, 8 a.m. to 5 p.m. EDT

For Customers With Special Needs...

***In the USA:
800.626.2005***

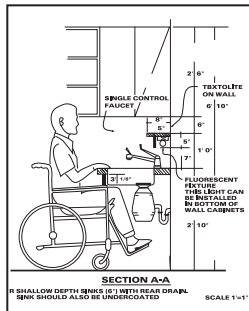

GE Appliances offers Braille controls for a variety of GE appliances, and a brochure to assist in planning a barrier-free kitchen for persons with limited mobility.

Consumers with impaired hearing or speech who have access to a TDD or a conventional teletypewriter may call 800.TDD.GEAC (800.833.4322) to request information or service.

Service Contracts

***In the USA:
800.626.2224***

***In Canada:
1.800.290.9029***

You can have the secure feeling that GE Appliances Consumer Service will still be there after your warranty expires. Purchase a GE Appliances contract while your warranty is still in effect and you'll receive a substantial discount. With a multiple-year contract, you're assured of future service at today's prices.

Parts and Accessories

***In the USA:
877.959.8688***

***In Canada:
1.800.561.3344***

Individuals qualified to service their own appliances can have parts or accessories sent directly to their home. The GE Appliances parts system provides access to over 47,000 parts...and all GE Appliances Genuine Renewal Parts are fully warranted. VISA, MasterCard and Discover cards are accepted.

User maintenance instructions contained in this manual cover procedures intended to be performed by any user. Other servicing generally should be referred to qualified service personnel. Caution must be exercised, since improper servicing may cause unsafe operation.

YOUR MONOGRAM REFRIGERATOR WARRANTY
Staple sales slip or cancelled check here. Proof of original purchase date is needed to obtain service under warranty.

WHAT IS COVERED

From the Date of the Original Purchase

LIMITED TWO-YEAR WARRANTY

For two years from date of original purchase, we will provide, free of charge, parts and service labor in your home to repair or replace *any part of the refrigerator* that fails because of a manufacturing defect.

LIMITED FIVE-YEAR WARRANTY

For five years from date of original purchase, we will provide, free of charge, parts and service labor in your home to repair or replace *any part of the sealed refrigerating system* (the compressor, condenser, evaporator and all connecting tubing) that fails because of a manufacturing defect.

LIMITED ADDITIONAL SIXTH- THROUGH TWELFTH-YEAR WARRANTY ON THE SEALED SYSTEM

For the sixth through twelfth year from the date of the original purchase, we will provide, free of charge, replacement parts for *any part of the sealed refrigerating system* (the compressor, condenser, evaporator and all connecting tubing) that fails because of a manufacturing defect. You pay for the service trip to your home and for service labor charges.

LIMITED THIRTY-DAY WARRANTY ON WATER FILTER CARTRIDGE Appliances (Water filter, if included)

From the date of the original purchase we will provide, free of charge, replacement parts for *any part of the water filter cartridge* that fails because of a manufacturing defect. During this limited thirty-day warranty, we will also provide, free of charge, a replacement water filter cartridge.

.....
This warranty is extended to the original purchaser and any succeeding owner for products purchased for ordinary home use in the 48 mainland states, Hawaii, Washington, D.C. or Canada. If the product is located in an area where service by a GE Appliances Authorized Servicer is not available, you may be responsible for a trip charge or you may be required to bring the product to an Authorized GE Appliances Service location for service. In Alaska the warranty is the same except that it is LIMITED because you must pay to ship the product to the service shop or for the service technician's travel costs to your home.

All warranty service will be provided by our Factory Service Centers or by our authorized Customer Care® servicers during normal working hours.

Should your appliance need service, during warranty period or beyond, in the USA call 800.432.2737. In Canada: 800.561.3344. Please have your serial number and model number available when calling for service.

WHAT IS NOT COVERED

- Service trips to your home to teach you how to use the product.
- Replacement of house fuses or resetting of circuit breakers.
- Damage to the product caused by accident, fire, floods or acts of God.
- Failure of the product if it is used for other than its intended purpose or used commercially.
- Damage caused after delivery.
- Improper installation, delivery or maintenance. If you have an installation problem, contact your dealer or installer. You are responsible for providing adequate electrical, plumbing and other connecting facilities.
- Replacement of the light bulbs, if included, or water filter cartridge, if included, other than as noted above.
- Replacement of the water filter cartridge, if included, due to water pressure that is outside the specified operating range or due to excessive sediment in the water supply.
- Loss of food due to spoilage (in the USA only).
- Incidental or consequential damage caused by possible defects with this appliance.
- Product not accessible to provide required service.
- Damage caused by a non-GE Appliances brand water filter.

EXCLUSION OF IMPLIED WARRANTIES—Your sole and exclusive remedy is product repair as provided in this Limited Warranty. Any implied warranties, including the implied warranties of merchantability or fitness for a particular purpose, are limited to one year or the shortest period allowed by law.

Some states/provinces do not allow the exclusion or limitation of incidental or consequential damages, so the above limitation or exclusion may not apply to you. This warranty gives you specific legal rights, and you may also have other rights which vary from state to state/province to province. To know what your legal rights are in your state/province, consult your local or state/provincial consumer affairs office or your state's Attorney General.

224D3094P002
49-60721-4

04-16 GE
Printed in the United States

Warrantor in USA: GE Appliances,
Louisville, KY 40225

Warrantor in Canada: Mabe Canada Inc.



GE APPLIANCES
Appliance Park
Louisville, KY 40225