



Dishwashers

Safety Instructions..... 2-3

Operating Instructions

Care and Cleaning 22, 23

Getting Started..... 4-7

Loading the Dishwasher..... 10-21

Using the Dishwasher8-9

Troubleshooting Tips..... 24-26

Consumer Support

Consumer Support..... Back Cover

Warranty27

Owner's Manual

Dishwashers

CDT 725-765 Series

DDT 575 Series

GDF 570 Series

GDT 580-740 Series

PDT 750-760 Series

Lave-vaisselle

Manuel d'utilisation

La section française commence à la page 33

Lavaplatos

Manual del propietario

La sección en español empieza en la página 65

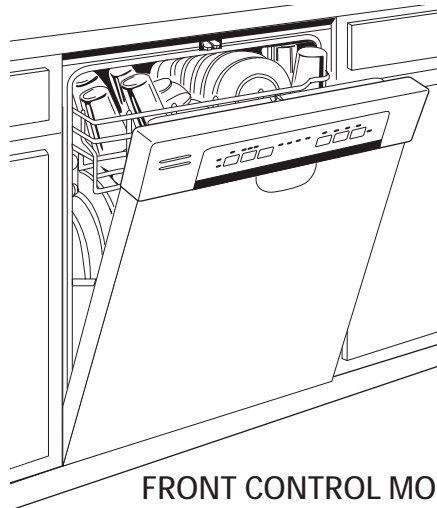

FRONT CONTROL MODELS

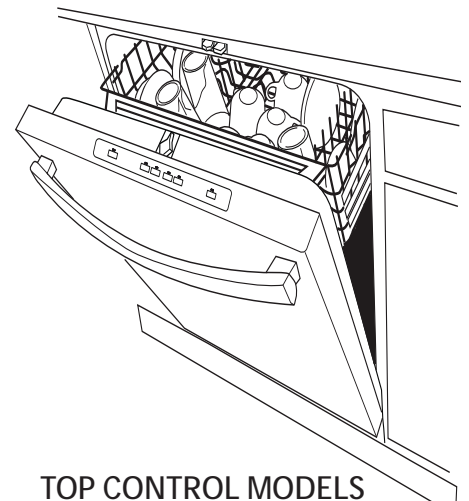

TOP CONTROL MODELS

Write the model and serial numbers here:

Model # _____

Serial # _____

You can find them on the tub wall, just inside the door.

IMPORTANT SAFETY INFORMATION

READ ALL INSTRUCTIONS BEFORE USING —

SAVE THESE INSTRUCTIONS

WARNING!

For your safety, the information in this manual must be followed to minimize the risk of fire, explosion, electric shock, and to prevent property damage, personal injury, or death.



WARNING! WATER HEATER SAFETY

Under certain conditions, hydrogen gas may be produced in a water heater that has not been used for two or more weeks. HYDROGEN GAS IS EXPLOSIVE.

If the hot water has not been used for two or more weeks, prevent the possibility of damage or injury by turning on all hot water faucets and allowing them to run for several minutes. Do this before using any electrical appliance connected to the hot water system. This simple procedure will allow any built-up hydrogen gas to escape. Since the gas is flammable, do not smoke, use an open flame, or use the appliance during this process.



WARNING! *When using your dishwasher, follow basic precautions, including the following:*

- Use this appliance only for its intended purpose as described in this Owner's Manual.
- Do not operate your dishwasher unless all enclosure panels are properly in place.
- Do not store or use combustible materials including gasoline or other flammable liquids or vapors in the vicinity of this or any other appliance.
- Do not abuse, sit on, hang from, or stand on the door or dish rack of the dishwasher.
- Do not tamper with controls.
- Do not wash plastic items unless marked dishwasher safe or the equivalent. For plastic items not so marked, check the manufacturer's recommendations.



WARNING! PROPER INSTALLATION AND MAINTENANCE

This dishwasher must be properly installed and located in accordance with the Installation Instructions before it is used. If you did not receive an Installation Instructions sheet with your dishwasher, you can receive one by visiting our Website at GEAppliances.com. In Canada, visit www.GEAppliances.ca.

- Connect the dishwasher/appliance to a grounded metal, permanent wiring system; or run an equipment-grounding conductor with the circuit conductors and connect to the equipment-grounding terminal or lead of the appliance.
 - Improper connection of the equipment-grounding conductor can result in a risk of electric shock. Check with a qualified electrician or service representative if you are in doubt whether the appliance is properly grounded.
 - Dispose of discarded appliances and shipping or packing material properly.
 - Do not attempt to repair or replace any part of your dishwasher unless it is specifically recommended in this manual. All other servicing should be referred to a qualified technician.
 - To minimize the possibility of electric shock, disconnect this appliance from the power supply before attempting any maintenance.
- NOTE:** Turning the dishwasher off does not disconnect the appliance from the power supply. We recommend having a qualified technician service your appliance.

IMPORTANT SAFETY INFORMATION READ ALL INSTRUCTIONS BEFORE USING — SAVE THESE INSTRUCTIONS

GEAppliances.com

⚠ WARNING! RISK OF CHILD ENTRAPMENT

- Do not allow children to play with, on, or inside this appliance at any time.

PROPER DISPOSAL OF THE DISHWASHER

Junked or abandoned dishwashers are dangerous...even if they will sit for “just a few days.” If you are getting rid of your dishwasher, please follow the instructions below to help prevent accidents.

- Do not allow children to play with, on, or inside this or any discarded appliance.
- Take off the door of the washing compartment or remove the latch by removing the two screws from the latch receiver inside the tub (as shown).

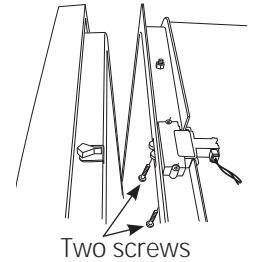

⚠ CAUTION: To prevent minor injury and property damage

- During or after wash cycle, contents may be hot to the touch. Use care before handling.
- Using a detergent that is not specifically designed for dishwashers will cause the dishwasher to fill with suds. 
- Non-Dishware Items: Do not wash items such as electronic air cleaner filters, furnace filters and paint brushes in your dishwasher. Damage to the dishwasher and discoloration or staining of the dishwasher may result.
- Close supervision is necessary if this appliance is used by or near children. Do not allow children to play around the dishwasher when closing the door, closing the upper rack, or while vertically adjusting the upper rack due to the possibility of small fingers being pinched.
- Load light-weight, plastic items so they do not become dislodged and drop to the bottom of the dishwasher—they might come into contact with the heating element and be damaged.
- Locate sharp items so that they are not likely to damage the door seal.
- Load sharp knives with the handles up to reduce the risk of cut-type injuries.
- Do not touch the heating element during or immediately after use.

⚠ CAUTION: ELECTRICAL REQUIREMENTS

- This appliance must be supplied with 120V, 60 Hz, and connected to an individual, properly grounded branch circuit protected by a 15 or 20 amp circuit breaker or time-delay fuse.
- If the electric supply provided does not meet the above specifications, it is recommended that a licensed electrician install an approved electrical connection.
- Your dishwasher circuit should not be used for any other appliance while the dishwasher is in operation as the dishwasher requires the full capacity of the circuit.
- If the wall receptacle you plug the dishwasher's power cord into is controlled by a switch, turn on the switch.

⚠ NOTICE

- If your dishwasher is connected to a wall switch, ensure that the switch is on prior to use.
- If you choose to turn the wall switch off between wash cycles, allow 5-10 seconds after turning the switch on before touching *Start* to allow the control to initialize.
- Use only powder, *Cascade® Platinum Pacs*, liquid detergents or rinse agents recommended for use in a dishwasher and keep them out of the reach of children. *Cascade® Platinum Pacs* Automatic Dishwashing Detergent, and *Cascade® Complete Rinse Aid* rinse agents are recommended for use in all GE dishwashers.

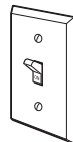

READ AND FOLLOW THIS SAFETY INFORMATION CAREFULLY.

SAVE THESE INSTRUCTIONS

Getting started!

Features and appearance will vary throughout this manual

GDF570

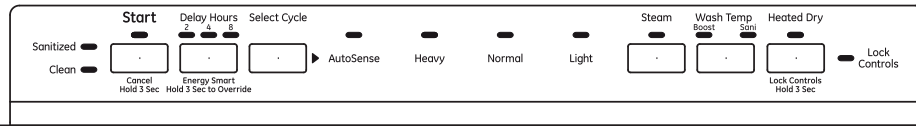

DDT575, GDT580

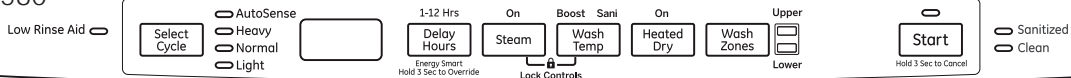

GDT720

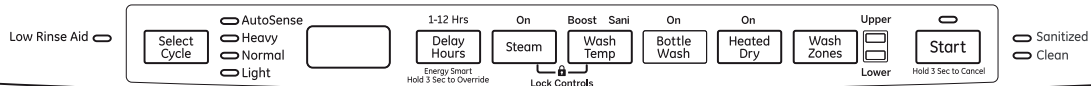

GDT740, PDT750, PDT760

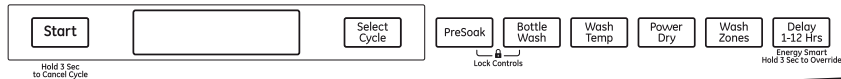

CDT725



CDT765



1 Load Dishwasher

For best dishwashing results, follow the loading guidelines found in the *Loading the dishwasher* section. No pre-rinsing of normal food soil is required. Scrape off hard soils, including bones, toothpicks, skins, and seeds. Remove leafy vegetables, meat trimmings, and excessive amounts of grease or oil.

2 Add Detergent

Add needed amount of detergent to the detergent dispenser. Use a detergent such as *Cascade® Platinum Pacs*. See *Detergent Dispenser* in the *Using the dishwasher* section.

3 Add Rinse Agent

Add Rinse Agent to the rinse agent dispenser. See *Use a Rinse Agent* in the *Using the dishwasher* section.

4 Select Cycle

Press the **Select Cycle** button for the desired wash cycle. On some models, the light next to the **Select Cycle** button will be lit to indicate which wash cycle has been selected. On other models, pressing the **Select Cycle** button will show various cycles in the display window. Press the button until the desired cycle is shown.

NOTE: Actual cycle times vary based on soil level, water temperature, and options selected.

The cycle may be selected with the door in the open position. The cycle will not start until after the door is closed and **Start** selected within 10 seconds.

AutoSense	This cycle automatically senses the soil level and adjusts the wash cycle accordingly. *Time range: 1 hour 50 minutes - 2 hours 10 minutes.
Heavy	This cycle is meant for heavily soiled dishes, cookware, pots, or pans with dried-on or baked-on soils. Everyday dishes are safe to be used in this cycle. *Time: 2 hours 31 minutes.
Normal	This cycle is meant for normal everyday soil levels and is designed to conserve both water and energy. *Time range: 1 hour 15 minutes - 1 hour 50 minutes. NOTE: Normal was used to rate the energy efficiency of this dishwasher.
Light	This cycle is for light to medium soiled dishes. It is safe for china and crystal. *Time: 50 minutes.
Rinse (on some models)	For rinsing partial loads that will be washed later. Do not use detergent. Detergent is not dispensed during the rinse cycle. *Time: 16 minutes.
Express (on some models)	This cycle will quickly wash lightly soiled dishes. *Time: 32 minutes. For faster drying, select Power Dry . The final rinse temperature will be increased. Power Dry will add 15 minutes to the cycle time. When the Clean light comes on, open the door, pull the racks out, and the dishes will "flash" dry in approximately five minutes.
eWash (on some models)	This cycle will efficiently wash dishes using about 2 gallons of water and .8 KWhr. Selecting Power Dry with this cycle adds an energy efficient 1 1/2 hour dry period. Drying is accomplished with an efficient 2 watt fan. *Time: 1 hour 3 minutes.

*Washing time only. Does not include drying time, **Auto Hot Start**, or options. **NOTE:** If the incoming water temperature is too low, the **Auto Hot Start** feature may add up to 11 minutes of additional time.

Getting started!

5 Select Options

The light by the selected button will be lit to indicate which Option has been selected.

Normal Temp (on some models)	This option is for normally soiled dishes, optimizes wash performance while conserving energy.
Wash Temp Boost or Boost Temp	This option increases the temperature to help clean heavily soiled dishes and may increase the overall cycle time. Option may be turned On or Off during the wash cycle. This option will also improve dry performance on the Normal cycle.
Wash Temp Sani or Sanitize Temp	This option raises the water temperature in the final rinse to sanitize your dishware. The cycle length will vary depending on the temperature of your inlet water. NOTE: This option is monitored for sanitization requirements. If the cycle is interrupted during or after the main wash portion or if the incoming water temperature is so low that adequate water heating cannot be achieved, the sanitizing conditions may not be met. In these cases, the Sanitized or Cycle Sanitized light will not illuminate at the end of the cycle. Utilizing this option will modify the cycle to meet the requirements of Section 6, NSF 184 for soil removal and sanitization efficacy. NOTE: NSF certified residential dishwashers are not intended for licensed food establishments.
Heated or Power Dry Off	Shuts off the drying option. Dishes air dry naturally and energy is saved. Open the dishwasher door to speed drying.
Heated or Power Dry On	Turns on the option for faster drying. This option may add up to 65 minutes to the cycle time. This option is not available with the Rinse cycle.
Steam (Prewash) (on some models)	For use with heavily soiled and/or dried-on, baked-on soils. This option MUST be selected PRIOR to starting the cycle. The Steam option adds up to 30 minutes to the cycle time. This option is available with Heavy , AutoSense , and Normal cycles.
Pre Soak (on some models)	Use this option to improve wash performance with heavy or dried-on soils. This option is available on Heavy , AutoSense , and Normal cycles and may add up to 30 minutes to the cycle time.
Wash Zones (on some models)	Selecting either the Upper or Lower Wash Zones will target dishwashing of just one rack. This will shorten the cycle time and conserve energy. This option should be used when dishes are placed in only one rack.
Bottle Wash (on some models)	This option increases the time that the bottle jets are on and may add up to 23 minutes to the cycle time. Use this to wash difficult to clean, dishwasher safe baby bottles, sport bottles, tall coffee cups, etc. See use recommendations in the Loading the dishwasher section.
Delay Hours	Delays the start of a wash cycle up to 8 to 12 hours depending on model. Press Delay Hours , to select the number of hours, then press Start one time and close door to begin countdown. The cycle will start once allotted time has expired.
Control Lock	You can lock the controls to prevent selections from being made. You can also lock the controls after you have started a cycle to prevent cycle changes. For example, children cannot accidentally start the dishwasher by pressing buttons with this option selected. To LOCK the dishwasher control , depending on the model, press and hold the 1 or 2 buttons indicated on the controls for 3 seconds. On some models, it will be the Heated Dry , another the Steam and Wash Temp buttons, and another model is the Pre-Soak and Bottle Wash buttons. The Control Lock light will turn on to indicate the control is locked. To UNLOCK the dishwasher control , depending on the model, press and hold the 1 or 2 buttons indicated on the controls for 3 seconds. The Control Lock light will turn off to indicate the control is unlocked.
Energy Smart	When connected to a smart meter and your electric company, the dishwasher will automatically delay starting a cycle during the more expensive peak demand times, and run when demand is low. However, you can override the delay settings and use the dishwasher as needed. Learn more about Energy Smart under the Using the Dishwasher section.

6 Start Dishwasher

Start	Open door to select the desired options. Press the Start button and close the door within 10 seconds to start the cycle or begin the Delay Hours countdown. The wash cycle will begin shortly after closing the door. The display will turn off if the door remains open for two minutes. To activate the display, close and open the door or press any button.
Interrupt or Pause	To interrupt or pause a dish cycle, slowly open the door. Opening the door will cause the wash cycle to pause. The dishwasher will beep every minute to remind you to close the door. To restart or resume the cycle, press Start , and close the door within 10 seconds.
Cancel	To cancel a wash cycle, press and hold the Start button for 3 seconds and close door. The dishwasher will drain, emit a beep sound, and the wash cycle light will turn OFF.

7 Cycle Indicator Lights and Sounds

Sanitized or Cycle Sanitized	Displayed at end of the cycle when Wash Temp Sani or Sanitize Temp has been selected and dishwasher has met requirements for sanitization. See Wash Temp Sani or Sanitize Temp for complete description. Closing door or pressing any button will turn off light.
Clean or Cycle Complete	Displayed when a wash cycle is complete. The light stays ON as a reminder that the dishes are clean.
Low Rinse Aid (on some models)	Displayed when rinse agent is low or empty. See page 8 for Use a Rinse Agent. To turn indicator off, press the Pre-Soak or Steam button 7 times within 5 seconds. Repeat this process to turn the Low Rinse Aid indicator back on.
Cycle Status (on some models)	The indicator light on the door front will change color to indicate the wash status. During the wash cycle, the indicator light will be amber. When the wash cycle is complete, the light will change to green.
Sounds	The dishwasher will emit a sound to indicate cycle completion, button presses, and door ajar. To mute all sounds, press the Heated Dry or Power Dry button 7 times within 5 seconds. Repeat this process to turn sounds back on.
Door Wake Up Mode (on some models)	To turn this option ON/OFF , press and hold the START and WASH TEMP buttons for 5 seconds. In the OFF mode, the control display, control sounds, and interior lights (on some models) will not respond to the door opening/closing. This mode can be used when observing certain religious holidays such as the Sabbath. To activate the control and interior lights, press any button.

Using the dishwasher.



Check the Water Temperature

The entering water should be at least 120°F (49°C) and not more than 150°F (66°C) for effective cleaning and to prevent dish damage. Check the water temperature with a candy or meat thermometer.

Turn on the hot water faucet nearest the dishwasher, place the thermometer in a glass and let the water run continuously into the glass until the temperature stops rising.



Energy Smart

Energy Smart enables your dishwasher to reduce energy consumption during periods of high energy costs. If you are in an area where your electricity provider charges variable rates at different times of the day, your dishwasher will inform you of those times when you are paying the highest rate. You can then either delay starting your dishwasher until the rate goes down; or you can override the feature and run your dishwasher at your convenience.

What you will need:

- 1 Smart Meter that will communicate with your dishwasher. Consult your local electricity provider to determine if the technology is available in your area.
- 2 An Energy Smart dishwasher model (CDT725-765, DDT575, GDF570, GDT580-740, PDT750-760).
- 3 An Appliance Communication Module (ACM). Please visit, gebrillion.com to order the communication device that will need to be installed in the dishwasher.



Use a Rinse Agent

Rinse agents, such as *Cascade® Complete Rinse Aid* are designed for great drying action and to protect against spots and film build-up on your dishes, glasses, flatware, cookware, and plastic.

Filling the Dispenser

The rinse agent dispenser holds 3.5 oz. (104 ml) of rinse agent. Under normal conditions, this will last approximately one month.

- 1 Make sure the dishwasher door is fully open.
- 2 Open the Rinse Agent dispenser door.
- 3 Slowly add rinse agent until the cup is full. You may need to pause several times to allow rinse aid to settle.
- 4 Clean up any spilled rinse agent with a damp cloth to prevent foam from forming inside the dishwasher.
- 5 Close the Rinse Agent dispenser door.

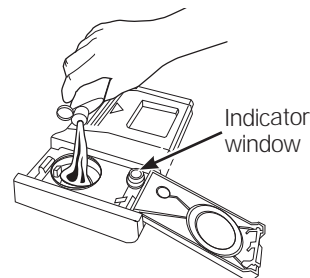

Rinse Aid Setting

The amount of rinse agent released into the final wash can be adjusted. If water drops or hard water spots remain on dishes after the dry cycle, increase the setting.

To adjust the setting

Open the Rinse Agent dispenser door; then turn the adjuster clockwise to increase the amount of rinse agent, counterclockwise to reduce the amount of rinse agent.



Clockwise to reduce water drops and hard water spots



Counterclockwise to reduce foaming

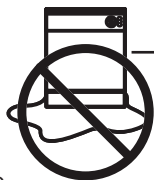
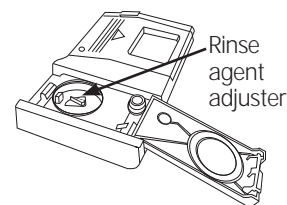

Leak Protection (on some models)

If a leak is detected, the dishwasher will drain and the cycle will stop. The display will show "LEAK DETECTED". Call for service.



Detergent Dispenser

The detergent dispenser is located in the center of the dishwasher door. It has two compartments. The main wash compartment is found inside the detergent dispenser. To open, press the button on the side of the dispenser. The pre-wash compartment is on the lid of the detergent dispenser. Use the pre-wash compartment only when your water is extremely hard or when you have a heavy soiled load. The pre-wash compartment is not used when tablet or packet detergents are used.

NOTE: Do not load large items in the lower rack where they may block the wash jets from rinsing out the detergent dispenser.

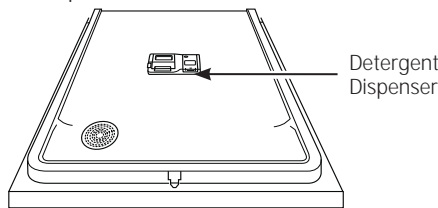

You may use tablet, packet, powder, liquid or gel automatic dishwasher detergent. Make sure you use only detergents specifically labeled for use in automatic dishwashers. Never use liquid hand dish detergent in an automatic dishwasher. Sudsing and poor wash performance will result with the use of improper detergents.

Detergents should be stored in a dry location and in their original container to prevent loss of effectiveness. Place detergent in the cup just prior to starting the dishwasher and then close the cover. The cover will open during the wash cycle.

Filling the Detergent Dispenser

GE recommends using detergent in tablet or packet form. Independent testing has shown this form of detergent is very effective in the dishwasher. *Cascade® Platinum Pacs* are an example of this type of detergent. Simply put a tablet or packet into the main wash compartment and slide to close the detergent cup cover. Please notice that the tablet or packet must be placed in the main wash compartment of the detergent cup. If the tablet or packet is tossed in the bottom of the dishwasher, the detergent will be flushed down the drain in a very short period of time and will thus be wasted. Wash performance will be very poor as a result.

If you choose to use detergent in powder, liquid or gel form, the amount of detergent you use will be determined by the hardness of your water, the temperature of your water, and the food soil load inside the dishwasher. Contact your water company to get information about the hardness of the water in your area. Water hardness is measured in grains per gallon. Use this information and the table above to determine the amount of detergent to use. You may purchase a hard water test strip from GE. Call 1-877-959-8688 and ask for part number **WD01X10295**. In Canada, call 1-800-661-1616.

Number of Grains/Gal.	Detergent Cups to Fill
Less than 4	Fill cup to 1/3 full
4 to 8	Fill cup to 2/3 full
8 to 12	Fill cup completely full
Greater than 12	Fill both main wash cup and pre wash cup

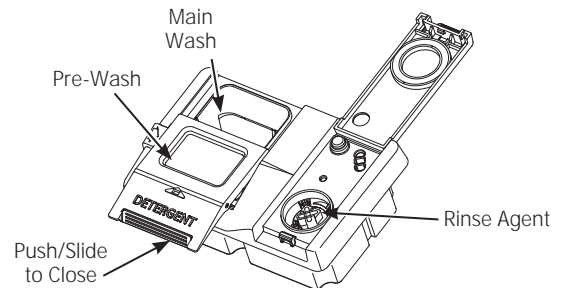

Using too much detergent with very soft and/or very hot water may cause a condition called etching on your glassware. Etching is a permanent cloudiness in your glassware. This condition is irreversible. However, using too little detergent will cause poor wash performance.

Use the table as a starting point and then adjust the amount of detergent you use. Use just enough to get good wash performance. Using just the right amount of detergent will provide great wash performance without wasting detergent or etching glassware.

DO NOT USE HAND DISH DETERGENT

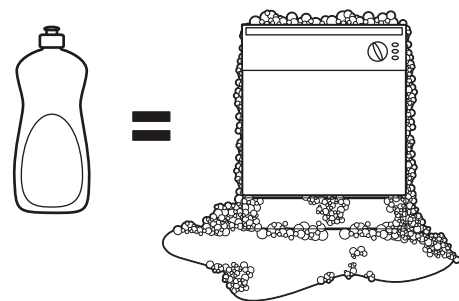

NOTE: Using a detergent that is not specifically designed for dishwashers will cause the dishwasher to fill with suds. During operation, these suds will spill out of the dishwasher vents, covering the kitchen floor and making the floor wet.

Because so many detergent containers look alike, store the dishwasher detergent in a separate space from all other cleaners. Show anyone who may use the dishwasher the correct detergent and where it is stored.

While there will be no lasting damage to the dishwasher, your dishes will not get clean using a dishwashing detergent that is not formulated for automatic dishwashers.

Loading the dishwasher.

For best dishwashing results, follow these loading guidelines. Features and appearance of racks and silverware baskets may vary from your model.

Upper Rack

The upper rack is primarily for glasses, cups, and saucers. For best wash performance, tilt cup and glass openings toward the center of the rack. Other items such as pots, pans, and plates may be placed in the upper rack. This is also a secure place for dishwasher-safe plastic items. The upper rack can be used for odd sized utensils. Sauce pans, mixing bowls, and other similarly shaped items should be placed face down for best wash performance. Ensure small plastic items are secure so that they cannot fall on the heater at the bottom of the dishwasher, potentially damaging the item. Some models are equipped with a hidden heater, so dishwasher safe plastic items can be placed in the lower rack.

IMPORTANT: Ensure items in the upper rack do not interfere with the 3rd Rack (on some models) when loading and unloading.

IMPORTANT: Ensure that items do not protrude through the bottom of the rack or silverware basket where they will block the rotation of the middle spray arm. This could result in noise during operation and/or poor wash performance.

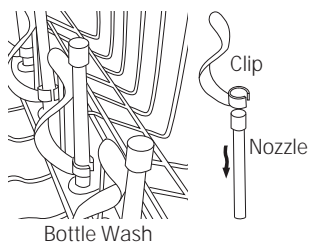
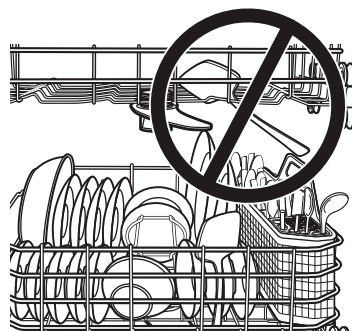

The **Bottle Wash** system (on some models) is the ideal location to position baby bottles and tall sports bottles. The **Bottle Wash** clips hold bottles with small openings in place so water jets are directed inside the bottles to clean hard to reach areas. Clips can be installed or removed by simply slipping the clip opening over the top of the nozzle.

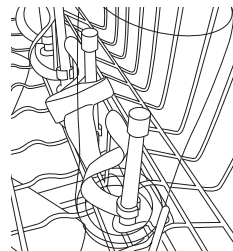

Sports bottle held in place *over* a Bottle Wash clip

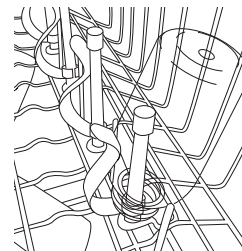

Baby bottle held in place *under* a Bottle Wash clip

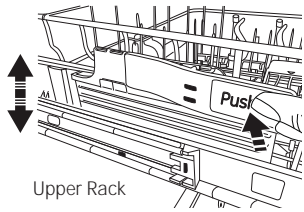

The upper rack allows 2" of adjustment up or down to accommodate large items. The upper rack may be lowered by pushing the long flaps on each side of the rack. This will allow you to lower the rack (see fig. Upper Rack). To raise the rack, lift up on the rack until the rack locks in place.

⚠ CAUTION: A loaded upper rack may be heavier than anticipated. To prevent minor injury or damage to the contents, do not raise or lower the upper rack after the rack is loaded.

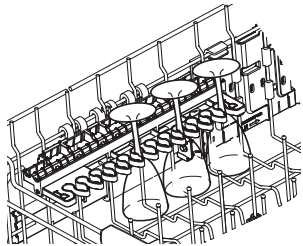

To add flexibility in loading, the utility shelf (on some models) may be placed in the up or down position or unfolded and placed in the lower unfolded position. The shelf may also be used to secure stemware such as wine glasses. Because these stemware items come in various sizes, slowly push the rack in to ensure the items do not bump into the edges of the dishwasher, which may cause damage to the items.

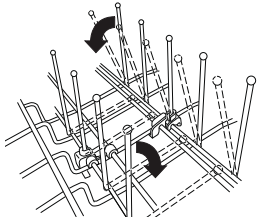

The fold down tines (on some models) provide flexibility for extra-large and hard-to-fit items. The tine rows can be adjusted to a vertical or lay-down position.

Loading the dishwasher.

For best dishwashing results, follow these loading guidelines. Features and appearance of racks and silverware baskets may vary from your model.

8 Place Settings - Upper Rack

Models - GDT580, GDT720, GDT740, PDT750 and CDT725

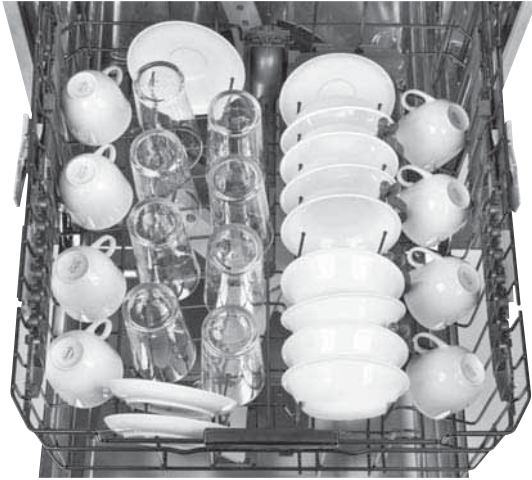

Models - GDF570 and DDT575

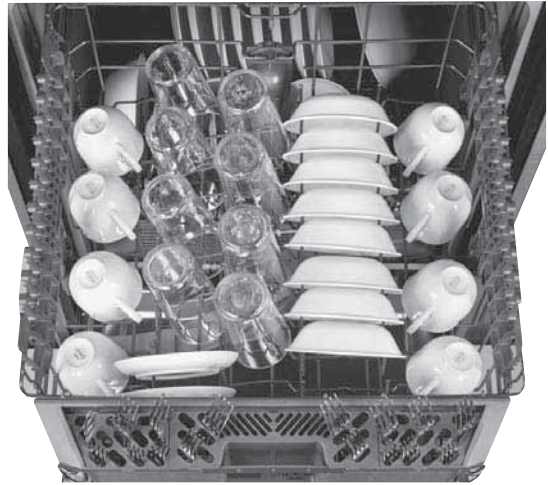

10 Place Settings - Upper Rack

Models - GDT580, GDT720, GDT740, PDT750 and CDT725



Models - GDF570 and DDT575

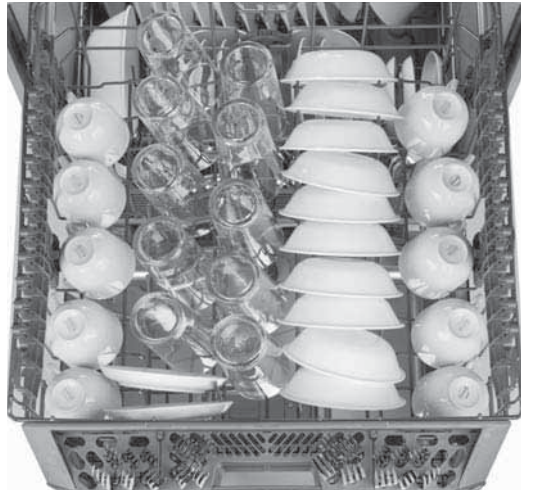

12 Place Settings - Upper Rack

Models - GDT580, GDT720, GDT740, PDT750 and CDT725



Models - GDF570 and DDT575

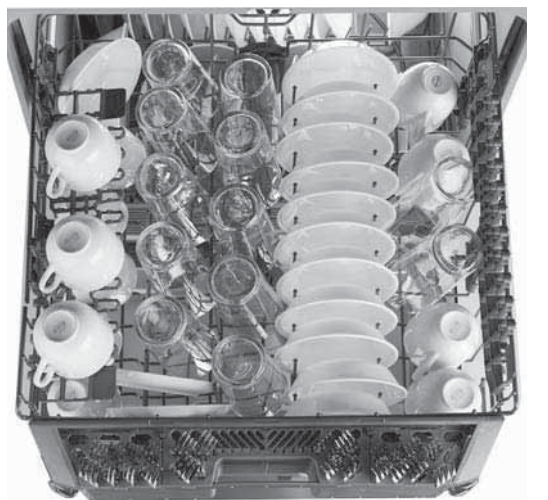

8 Place Settings - Upper Rack

Models - PDT760 and CDT765



10 Place Settings - Upper Rack

Models - PDT760 and CDT765



12 Place Settings - Upper Rack

Models - PDT760 and CDT765



Loading the dishwasher (cont.)

For best dishwashing results, follow these loading guidelines. Features and appearance of racks and silverware baskets may vary from your model.

Lower Rack

The lower rack is best used for plates, saucers and cookware items. Large items, such as broiler pans and baking racks should be placed along the sides of the rack. If necessary, oversized glasses and mugs can be placed in the lower rack to maximize loading flexibility. Plates, saucers and similar items should be placed between the tines in the direction that allows the item to remain secure in the rack.

The lower rack **fold down tines** (on some models) can be adjusted to different upright angles or placed flat to provide flexibility for hard-to-fit or extra-large items.

NOTE: Do not load large items in the lower rack where they may block the wash jets from rinsing out the detergent dispenser.

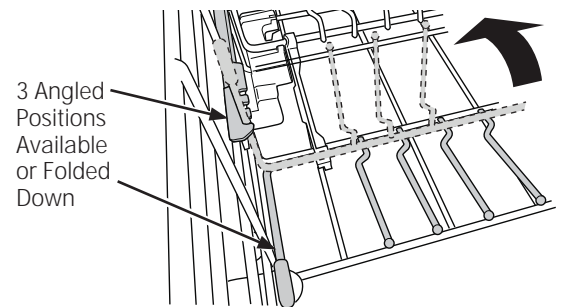

The **reversible tine blocks** (on some models) are designed to allow greater flexibility in loading dishes. The direction of the tine blocks can be changed to match your preferred loading direction as shown in Figure A or Figure B:

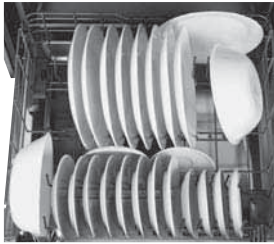

Figure A

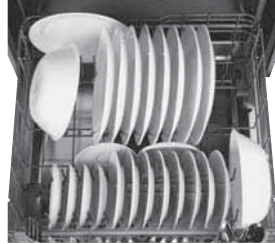
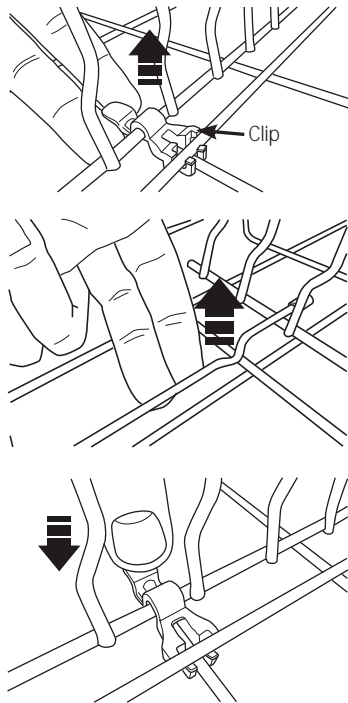

Figure B

To adjust the tine block direction, remove the clips securing the tine blocks to the racks by pulling up on the tab, then gently flex the retaining wire from the center to unseat the tine block from the lower rack. The tine block may be turned in the opposite direction to reverse loading direction. Secure the tine block to the rack using the same process and be sure to snap the clips back in place.



! WARNING! The clips can be a choke hazard for small children. Keep out of reach of children.

To change the direction of the **fold down tines**, lower the tines, then pull away from the bar clips that secure the tines to the rack and remove. Reverse the direction of the tines, orienting the handle on the opposite side of the rack. Reattach the tines to the bar clips by pushing the tines back until they click in place. The indexer will also need to be switched to the opposite side of the dishwasher. To remove the indexer, simply slide it in the direction labeled "unlock." Then, align the indexer with the rack on the other side and slide in the direction that says "lock" in order to reattach the indexer to the rack.

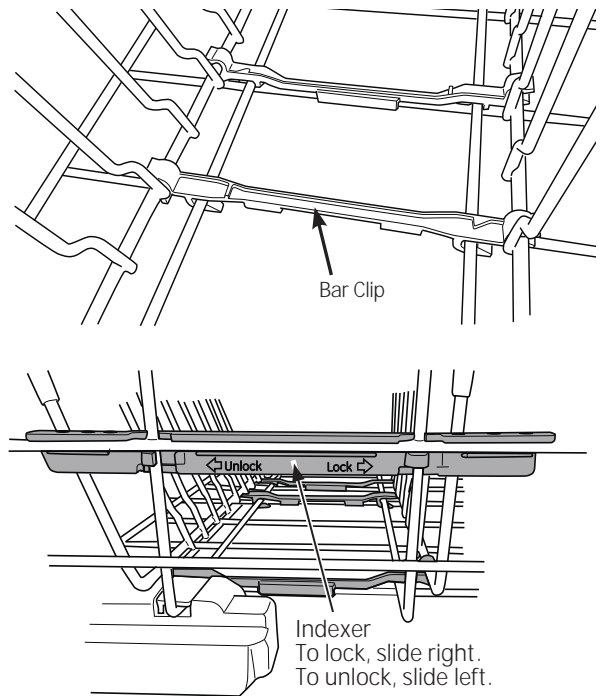

IMPORTANT: It is important to ensure that items do not protrude through the bottom of the rack or the silverware basket where they will block the rotation of the lower spray arm. Also, ensure that large plates, pots, or tall items don't hit the mid spray arm. This could result in noise during operation and/or poor wash performance.

Loading the dishwasher (cont.)

8 Place Settings - Lower Rack

Models - GDT580, GDT720, GDT740, PDT750 and CDT725

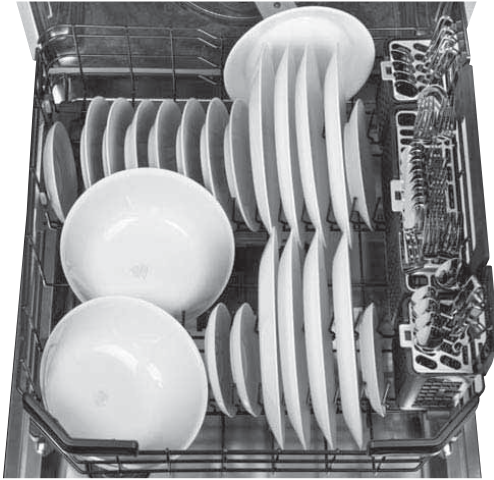

Models - GDF570 and DDT575

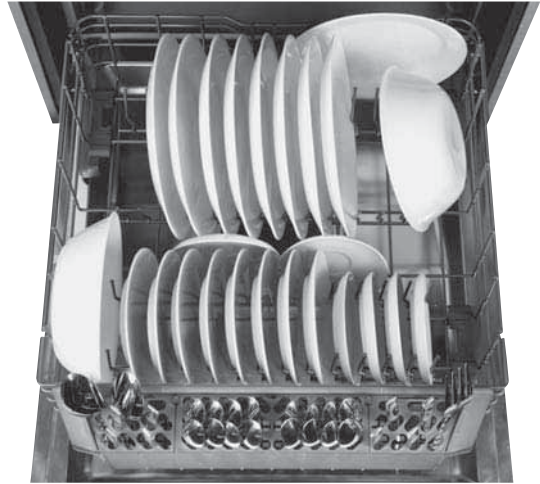

10 Place Settings - Lower Rack

Models - GDT580, GDT720, GDT740, PDT750 and CDT725



Models - GDF570 and DDT575



12 Place Settings - Lower Rack

Models - GDT580, GDT720, GDT740, PDT750 and CDT725

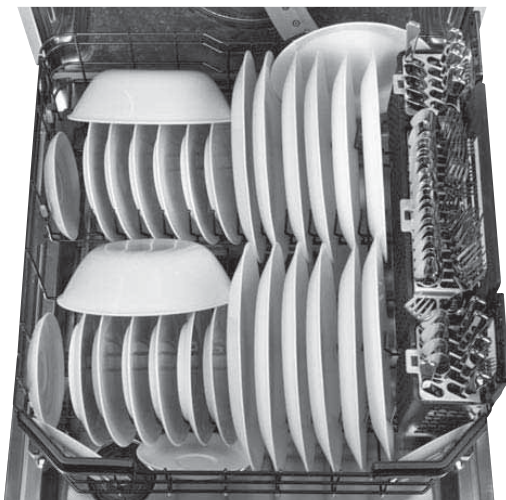

Models - GDF570 and DDT575

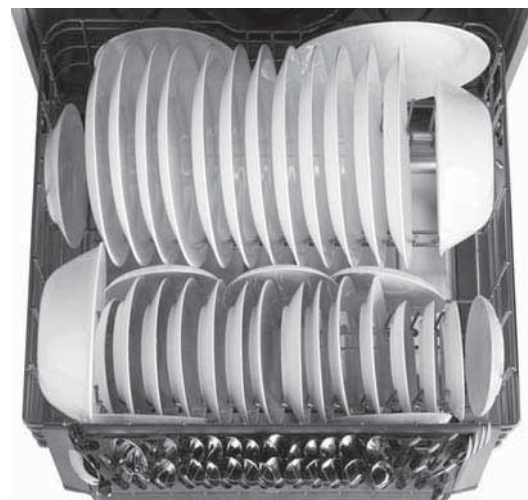

8 Place Settings - Lower Rack

Models - PDT760 and CDT765



10 Place Settings - Lower Rack

Models - PDT760 and CDT765



12 Place Settings - Lower Rack

Models - PDT760 and CDT765

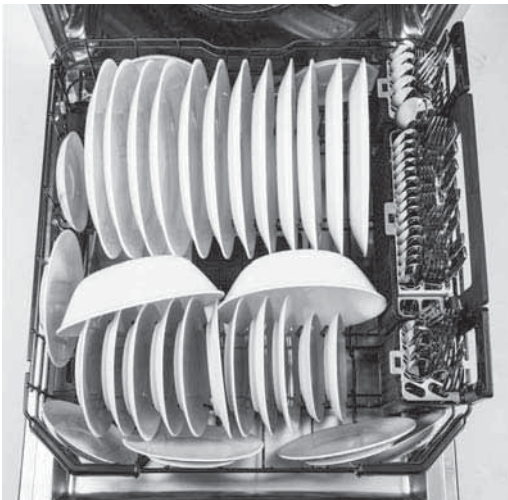

Loading the dishwasher (cont.).

For best dishwashing results, follow these loading guidelines. Features and appearance of racks and silverware baskets may vary from your model.

3rd Rack (on some models)

The 3rd rack is the recommended location for silverware and has 2 trays:

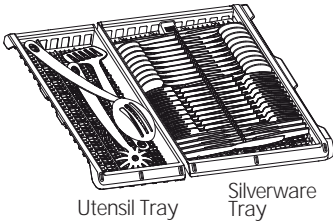

The utensil tray holds serving spoons, chop sticks, spatulas, cutlery, whisks, etc. Be sure not to overlap the utensil heads.

The silverware tray holds silverware individually in slots and is positioned by alternating the heads of the silverware.

These trays may be removed to allow for easier loading and unloading, changing the side that the trays are on, or to create extra space for the upper rack.

To remove a tray, fully extended the 3rd rack, grasp both the front and back handles on one tray and gently lift the tray out of the rack. To replace the tray, grasp both handles and gently place it on the rack so that the deepest part is towards the center of the rack.

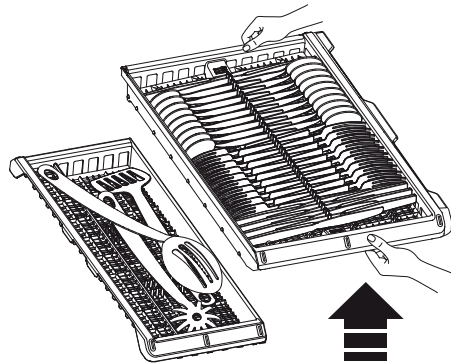

! CAUTION! Take care when loading, unloading, or transporting the silverware or utensil trays. The trays may contain sharp or heavy items. If items are dropped from the trays or the trays are dropped, injury could occur.

IMPORTANT NOTES:

- Do not place cutlery of different materials next to each other in the 3rd rack. Doing so may cause discoloration of the cutlery.
- The trays are only meant to be used with a GE 3rd rack dishwasher to hold silverware, cooking utensils, and other small items. Using the trays for any other purpose could result in damage to the trays or damage to anything interacting with the trays.
- Ensure that the 3rd rack is fully closed before shutting the dishwasher door. Shutting the door with the rack partially extended could cause damage to the dishwasher.

8 Place Settings

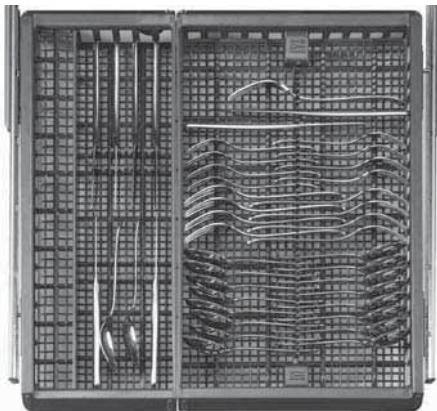

10 Place Settings

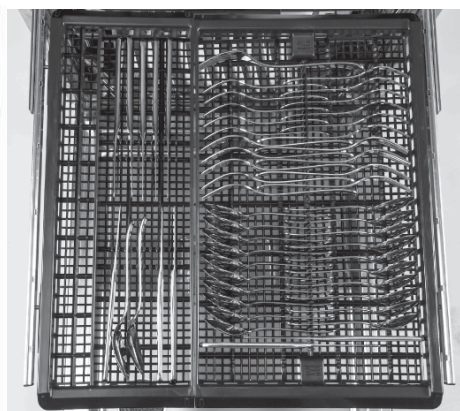

12 Place Settings



*See **Silverware Basket** section on how to load silverware.

The 3rd rack is also removable to allow extra large items to be placed in the upper rack:

To remove the 3rd rack:

- 1 Remove the silverware and utensil trays. (See the **IMPORTANT NOTES** in this section.)
- 2 Push the rack all the way to one side so that a gap between it and the side rail forms on the other side. Align the side rail posts with the center of the clips on the rack and lift straight up.

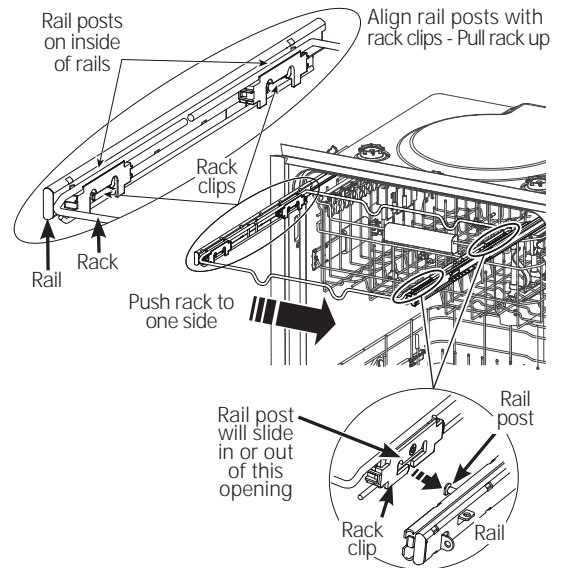
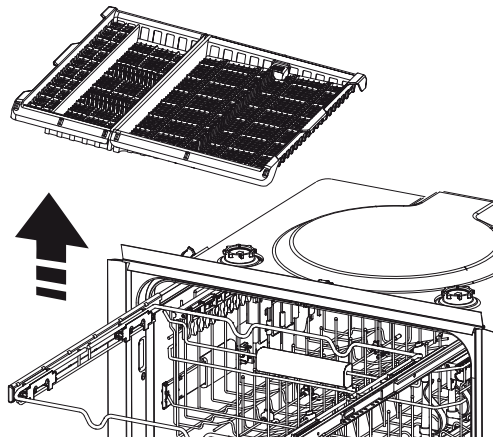

- 3 Continuing to hold the rack in the lifted position, repeat on the other side.
- 4 Once the rack is removed, push the side rails all the way back into the dishwasher.

To replace the 3rd rack:

- 1 Extend both side rails fully out of the dishwasher.
- 2 Orient the rack so that its side clips are aligned and centered with the posts on the side rail and lower the clips onto the posts.
- 3 Move the rack to one side of the dishwasher until the clips fall onto the posts.
- 4 Continuing to hold the rack in the lifted position, repeat on the other side.
- 5 Once the rack is replaced, pull it all the way out to lock it in place in its side rails.

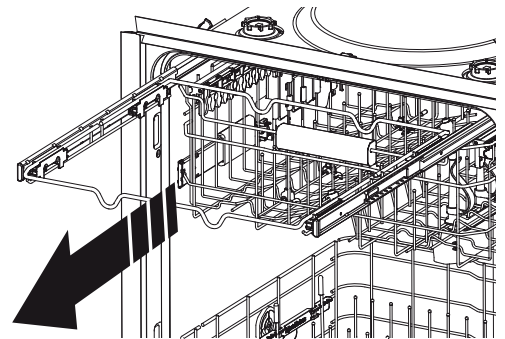
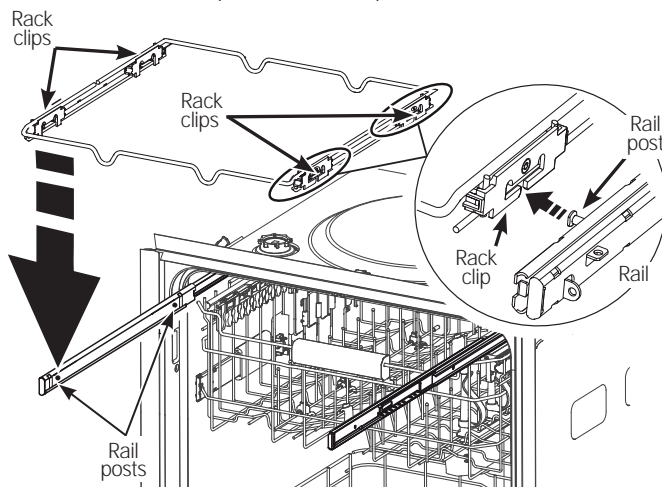

- 6 Replace the silverware and utensil trays.

Loading the dishwasher (cont.).

For best dishwashing results, follow these loading guidelines. Features and appearance of racks and silverware baskets may vary from your model.

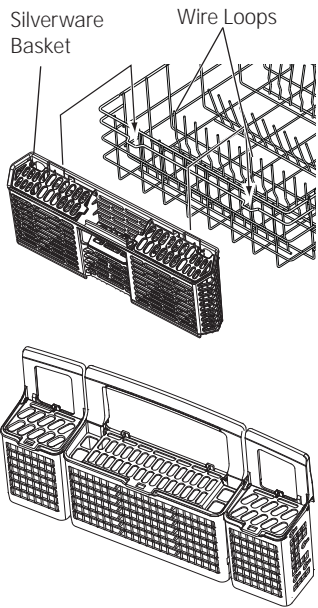

Silverware Basket

Place flatware in the removable silverware baskets. Sharp objects, such as forks and knives, may be placed with the handles facing up, in order to protect your hands. For the best wash performance, place other items such as spoons with the handles facing down. Avoid allowing items to nest together, which may keep them from being properly washed. When loading, distribute items evenly in the basket.

The silverware baskets may also be used for small items, such as measuring spoons, baby bottle nipples, plastic lids, or corn cob holders. The silverware basket covers can be closed to contain small items.

The Easy Access Silverware Baskets (on GDF570 and DDT575 models) may be positioned on the front of either the upper or lower racks. Secure the basket to the rack using the wire loop on the front of the upper and lower racks to engage the tabs on the rear of the basket.

On other models, the silverware basket may be positioned by placing the hooks on the back of the basket over the top wire on the sides of the lower rack.

IMPORTANT NOTE: Do not load large or tall utensils where they may block the detergent dispenser, mid spray arm, or become trapped between the door and the gasket when the door is closed.

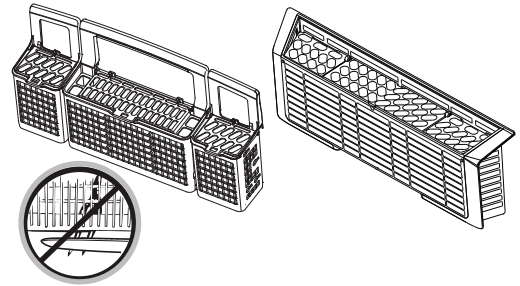

Silverware/flatware is loaded using the silverware basket lids. This ensures great wash performance of the silverware. Loading in this manner prevents nesting and makes sure all items are washed uniformly.

8 Place Settings - Silverware Basket

Models - GDT580, GDT720, GDT740, PDT750 and CDT725



NOTE: For models PDT760 and CDT765, refer to the 3rd Rack in this Loading The Dishwasher section.

Models - GDF570 and DDT575

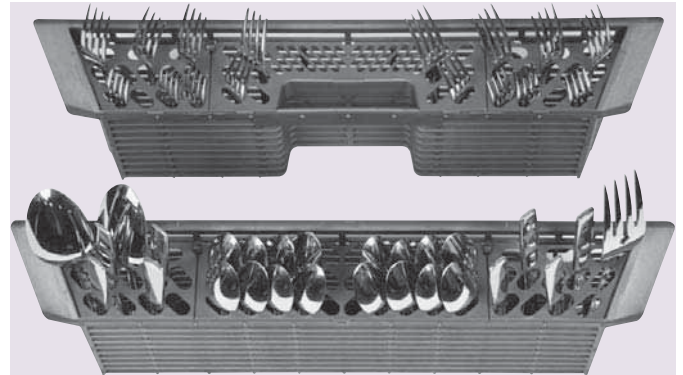

10 Place Settings - Silverware Basket

Models - GDT580, GDT720, GDT740, PDT750 and CDT725



NOTE: For models PDT760 and CDT765, refer to the 3rd Rack in this Loading The Dishwasher section.

Models - GDF570 and DDT575

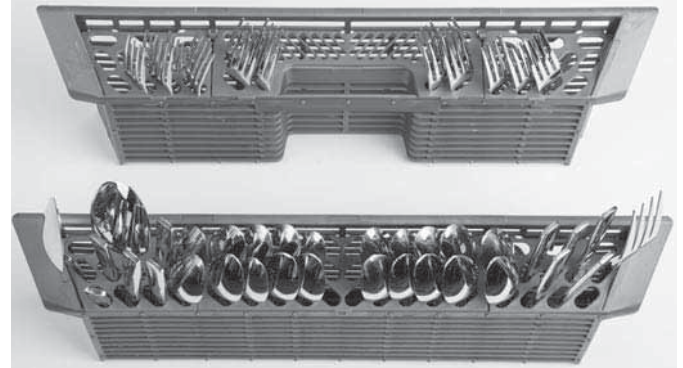

12 Place Settings - Silverware Basket

Models - GDT580, GDT720, GDT740, PDT750 and CDT725



Models - GDF570 and DDT575

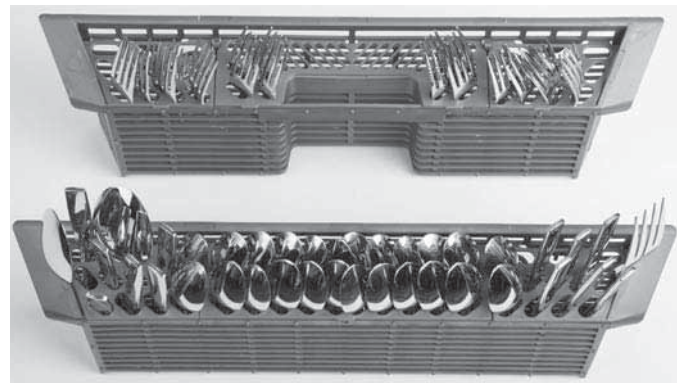

Models - PDT760 and CDT765

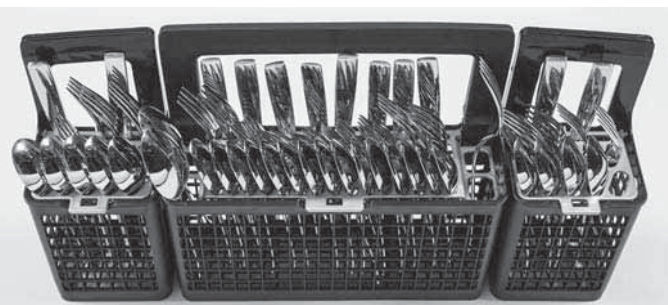

Care and cleaning.

Cleaning the Exterior Door Panel

Before cleaning the front panel, make sure you know what type of panel you have. Refer to the last two letters of your model number. You can locate your model number on the left-hand tub wall just inside the door. If your model number ends with BB, CC, WW, SA or ES then you have a painted door panel. If your model number ends with SS, then you have a Stainless Steel door panel. If your model number ends with II, then you have an Integrated door panel.

Follow the instructions below for cleaning the door panel for your specific model.

Painted Door Panel (model numbers ending in BB-black, CC-bisque, WW-white, SA-silver or ES-slate)

Use a clean, soft, lightly dampened cloth, then dry thoroughly.

Stainless Steel Door Panel (model numbers ending in SS)

The stainless steel panels can be cleaned with *Stainless Steel Magic* or a similar product using a clean, soft cloth. Do not use appliance wax, polish, bleach or products containing chlorine on Stainless Steel doors.

Do not use scouring pads or powder cleaners because these products can scratch the finish.

You can order *Stainless Steel Magic* #WX10X29 through GE Parts by calling 1.877.959.8688 or visiting GEApplianceparts.com. In Canada, call 1-800-661-1616.

Integrated Door Panel (model numbers ending in II)

This is a custom installed door panel, and you will need to refer to the cabinet manufacturers recommendations for proper cleaning.

Cleaning the Control Panel

To clean the control panel, use a lightly dampened cloth. Then dry thoroughly.

Cleaning the Dishwasher Interior

To clean and de-odorize your dishwasher, use citric acid or Lemi Shine[®]*, a detergent additive. Lemi Shine will break up mineral deposits, and remove hard water film and stains. You can order citric acid #WD35X151 through GE Parts by calling 877-959-8688 or visiting GEApplianceparts.com. In Canada, call 1-800-661-1616. You can purchase Lemi Shine at your local grocery store or by calling GE at the numbers above and ask for WX10X10019.

Stainless Steel Inner Door and Tub

The stainless steel used to make the dishwasher tub and inner door provides the highest reliability available in a GE dishwasher.

If the dishwasher tub or inner door should be scratched or dented during normal use, they will not rust or corrode. These surface blemishes will not affect their function or durability.

Cleaning the Filters

Inspect and clean the filters periodically. This should be done every other month or so depending on usage. If there is a decrease in wash performance or dishes feel gritty, this is also an indication the filters need to be cleaned.

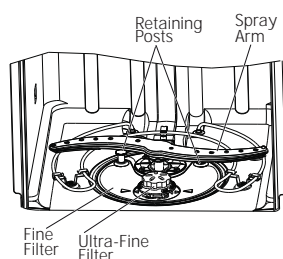

Ultra-Fine Filter

To clean the Ultra-Fine Filter, remove the bottom rack. Twist counterclockwise and remove the Ultra-Fine Filter. Rinse filter with warm soapy water and use a sponge to carefully remove any stubborn particles. Scrubbing with scouring pads or brushes can damage the filter. Once cleaned, replace the Ultra-Fine Filter, and twist clockwise to lock in place.

Fine Filter

To clean the Fine Filter (mesh plate), remove the bottom rack. Remove the Ultra-Fine Filter.

Twist counterclockwise each of the two retaining posts located toward the back bottom of the tub, and remove the Fine Filter. Rinse filter with warm soapy water. Scouring pads or brushes can scratch the filter surface but a soft brush or sponge may be needed to remove stubborn soils or calcium deposits caused by hard water. Once cleaned, replace the Fine Filter, the Ultra-Fine Filter, and twist clockwise the two retaining posts into place.

! WARNING! The retaining posts can be a choke hazard for small children. Keep out of reach of children.

Protect Against Freezing

If your dishwasher is left in an unheated place during the winter, ask a service technician to:

- 1 Turn off electrical power to the dishwasher. Remove fuses or trip circuit breaker.
- 2 Turn off the water supply and disconnect the water inlet line from the water valve.
- 3 Drain water from the water inlet line and water valve. (Use a pan to catch the water.)
- 4 Reconnect the water inlet line to the water valve.

Air gap



Check the air gap any time your dishwasher isn't draining well.

Does Your Dishwasher Have an Air Gap?

An air gap protects your dishwasher against water backing up into it if a drain clogs. The air gap is not a part of the dishwasher. It is not covered by your warranty. Not all plumbing codes require air gaps, so you may not have one.

The air gap is easy to clean.

- 1 Turn off the dishwasher and lift off the air gap cover.
- 2 Remove the plastic cap under the cover and clean with a toothpick.
- 3 Replace the cap and cover when the air gap is clean.

Before you call for service...



Troubleshooting Tips

Save time and money! Review the charts on the following pages, or visit GEAppliances.com. In Canada visit www.GEAppliances.ca. You may not need to call for service.

Problem	Possible Causes	What To Do
<i>Start status indicator light flashing</i>	The door was opened or the cycle was interrupted.	<ul style="list-style-type: none"> Press the Start button once and close the door to start the dishwasher. Press the Start button a second time when the dishwasher is running only if you wish to cancel the cycle.
<i>Dishwasher BEEPS once every minute</i>	This is a reminder that your dishwasher door has been left open during operation. It will continue beeping until you press Start and close the door.	<ul style="list-style-type: none"> Press Start and close the door.
<i>Display shows "LEAK DETECTED"</i>	Possible leak is detected	<ul style="list-style-type: none"> Some models are equipped with leak detection and the cycle will be cancelled if a leak is detected. The display will show "LEAK DETECTED". Call for service.
<i>Beeping at the end of the cycle (on some models)</i>	This is normal. The dishwasher will beep twice at the end of the cycle.	<ul style="list-style-type: none"> To turn off the double beep indicator (or re-activate it if it was previously turned off), press the Heated Dry button 5 times within 3 seconds. A triple beep will sound to indicate the end-of-cycle beep option has been turned on or off.
<i>Dishes and flatware not clean</i>	Ultra Fine or Fine filter is clogged	<ul style="list-style-type: none"> See the Care and cleaning section.
	Low inlet water temperature	<ul style="list-style-type: none"> Make sure inlet water temperature is correct (see the Using the dishwasher section). Turn on the hot water faucet nearest the dishwasher, let run until the water temperature stops rising. Then start the dishwasher and turn off the faucet. This ensures the entering water is hot. Select Wash Temp Boost or Boost Temp if available.
	Water pressure is temporarily low	<ul style="list-style-type: none"> Turn on a faucet. Is water coming out more slowly than usual? If so, wait until pressure is normal before using your dishwasher.
	Air gap or disposer is clogged	<ul style="list-style-type: none"> Clean the air gap or flush the disposer.
	Improper rack loading	<ul style="list-style-type: none"> Make sure large dishware does not block the detergent dispenser or the wash arms. See the Loading the dishwasher section.
	Poor performing detergent	<ul style="list-style-type: none"> Use a highly rated detergent such as Cascade® Platinum Pacs.
	Leak detected	<ul style="list-style-type: none"> Some models are equipped with leak detection and the cycle will be cancelled if a leak is detected. The display will show "LEAK DETECTED". Call for service.
<i>Spots and filming on glasses and flatware</i>	Extremely hard water	<ul style="list-style-type: none"> Use rinse agents such as Cascade® Complete Rinse Aid to prevent spots and prevent new film buildup. If water is extremely hard, a softener may be required.
	Low inlet water temperature	<ul style="list-style-type: none"> Make sure water temperature is at least 120°F (49°C).
	Overloading or improper loading of the dishwasher	<ul style="list-style-type: none"> Load dishwasher as shown in the Loading Place Settings section.
	Old or damp powder detergent	<ul style="list-style-type: none"> Make sure detergent is fresh.
	Rinse agent dispenser empty	<ul style="list-style-type: none"> Refill with rinse agent such as Cascade® Complete Rinse Aid.
	Too little or low performing detergent	<ul style="list-style-type: none"> Make sure you use the proper amount of highly rated detergent.

<i>Problem</i>	<i>Possible Causes</i>	<i>What To Do</i>
<i>Cloudiness on glassware</i>	Combination of soft water and too much detergent	<ul style="list-style-type: none"> This is called etching and is permanent. To prevent this from happening, use less detergent if you have soft water. Wash glassware in the shortest cycle that will get it clean.
	Low performing phosphate free detergent	<ul style="list-style-type: none"> See <i>A white film on glassware, dishware and the interior</i> in this <i>Troubleshooting</i> section.
	Water temperature entering the dishwasher exceeds 150°F (66°C)	<ul style="list-style-type: none"> This could be etching. Lower the water heater temperature.
<i>Suds in the tub</i>	Wrong detergent 	<ul style="list-style-type: none"> Use only automatic dishwasher detergents to avoid sudsing. <i>Cascade®</i> Automatic Dishwashing Detergents have been approved for use in all GE dishwashers. To remove suds from the tub, open the dishwasher and let suds dissipate. Open the door, press and hold Start for 3 seconds, and close the door.
	Rinse agent was spilled	<ul style="list-style-type: none"> Always wipe up rinse agent spills immediately.
<i>Detergent left in dispenser cups</i>	Dishes or utensils are blocking the detergent cup	<ul style="list-style-type: none"> Reposition the dishes, so the water from the lower spray arm can flush the detergent cup. See the <i>Loading the dishwasher</i> section. Reposition the tall utensils or heavy silverware that may be keeping the dispenser cup door from opening. See the <i>Loading the dishwasher</i> section. Don't place large bowls or pots directly under the detergent dispenser.
<i>Black or gray marks on dishes</i>	Aluminum utensils have rubbed against dishes	<ul style="list-style-type: none"> Remove marks with a mild, abrasive cleaner.
<i>Dishes don't dry</i>	Low inlet water temperature	<ul style="list-style-type: none"> Make sure inlet water temperature is at least 120°F. Select <i>Heated Dry</i> Use <i>Wash Temp Boost</i> or <i>Boost Temp</i> option. Select a higher cycle, such as <i>Wash Temp Sani</i>, <i>Sanitize Temp</i> or <i>Heavy</i>.
	Rinse agent dispenser is empty	<ul style="list-style-type: none"> Check the rinse agent dispenser and fill as required.
	Additional drying time is needed	<ul style="list-style-type: none"> Leave door closed after the Clean light appears to allow the fan to run an additional 90 minutes. Note: If you open the door, this fan extension will be cancelled.
	<i>Control panel responded to inputs but dishwasher never filled with water</i>	Door may not be completely closed
<i>Stained tub interior</i>	Water valve may be turned off	<ul style="list-style-type: none"> Make sure water valve (usually located under the sink) is turned on.
	Flood float may be stuck	<ul style="list-style-type: none"> Remove Ultra-Fine filter and lightly tap the piece under the ultra fine filter that looks like a salt shaker. Replace the filter.
<i>Dishwasher won't run</i>	White film on inside surface—hard water minerals	<ul style="list-style-type: none"> GE recommends <i>Cascade® Complete Rinse Aid</i> to help prevent hard water mineral deposits from forming. Run dishwasher with citric acid to remove mineral deposits. Citric acid (Part number: WD35X151) can be ordered through GE Parts. See back cover for ordering information. Alternatively, purchase Lemi Shine and follow the directions on the label.
	Fuse is blown or circuit breaker is tripped	<ul style="list-style-type: none"> Replace fuse or reset circuit breaker. Remove any other appliances from the circuit.
<i>Dishwasher won't run</i>	Power is turned off	<ul style="list-style-type: none"> In some installations, the power to the dishwasher is provided through a wall switch, often located next to the disposer switch. Make sure it is on.
	Control panel is locked	<ul style="list-style-type: none"> Unlock control panel. See the <i>Getting started</i> section.
	Possible leak is detected	<ul style="list-style-type: none"> Some models are equipped with leak detection and the cycle will be cancelled if a leak is detected. The display will show "LEAK DETECTED". Call for service.
	Proper <i>Start</i> sequence was not followed	<ul style="list-style-type: none"> See the <i>Using the dishwasher</i> section.

Before you call for service...

<i>Problem</i>	<i>Possible Causes</i>	<i>What To Do</i>
<i>Control panel lights go off when you're setting controls</i>	Time too long between touching of selected buttons	<ul style="list-style-type: none"> Each button must be touched within 30 seconds of the others. To relight, touch any button again or open the door and unlock (top control).
<i>Water standing in the bottom of the tub</i>	Air gap is clogged	<ul style="list-style-type: none"> Clean the air gap. See the <i>Care and cleaning</i> section.
	High drain loop or air gap not installed	<ul style="list-style-type: none"> Refer to the Installation Instructions for proper drain line installation.
<i>Water won't pump out of the tub</i>	Drain is clogged	<ul style="list-style-type: none"> If you have an air gap, clean it. See the <i>Care and cleaning</i> section. If the dishwasher drains into a disposer, run disposer clear. Check to see if your kitchen sink is draining well. If not, you may need a plumber.
<i>Steam</i>	This is normal	<ul style="list-style-type: none"> Warm, moist air comes through the vent during drying and when water is being pumped out. This is necessary for drying.
<i>Sanitized or Cycle Sanitized light does not illuminate at the end of the cycle</i>	The door was opened and the cycle was interrupted during final rinse	<ul style="list-style-type: none"> Do not interrupt the cycle by opening the door during the wash cycle.
	The incoming water temperature was too low	<ul style="list-style-type: none"> Raise the water heater temperature to between 120°F and 150°F.
<i>Noise</i>	Normal operating sounds: Detergent cup opening Water entering dishwasher The motor stops and starts at various times during the cycle Spray arms start and stop at various times Drain pump sounds during pump out Drain pump starts and stops several times during each drain	<ul style="list-style-type: none"> These are all normal. No action is required.
	Rattling dishes when the spray arm rotates	<ul style="list-style-type: none"> Make sure dishes are properly loaded. See the <i>Loading the dishwasher</i> section.
	Rattling silverware against door during wash	<ul style="list-style-type: none"> Tall utensils may be placed in the upper rack to avoid bumping against inner door during wash cycle.
	<i>A white film on glassware, dishware and the interior</i>	This problem is likely caused by a low quality phosphate-free dishwasher detergent

GE Dishwasher Warranty.

GEAppliances.com



All warranty service provided by our Factory Service Centers, or an authorized Customer Care® technician. To schedule service, visit us on-line at GEAppliances.com, or call 800.GE.CARES (800.432.2737) in the United States. In Canada, call 1.800.561.3344. Please have serial number and model number available when calling for service.

Staple your receipt here.
Proof of the original purchase date is needed to obtain service under the warranty.

Servicing your appliance may require the use of the onboard data port for diagnostics. This gives a GE Factory Service technician the ability to quickly diagnose any issues with your appliance and helps GE improve its products by providing GE with information on your appliance. If you do not want your appliance data to be sent to GE, please advise your technician NOT to submit the data to GE at the time of service.

For The Period Of: GE Will Replace:

One Year From the date of the original purchase	Any part of the dishwasher which fails due to a defect in materials or workmanship. During this limited one-year warranty , GE will also provide, free of charge , all labor and in-home service to replace the defective part.
---	--

What GE Will Not Cover (for customers in the United States):

- Service trips to your home to teach you how to use the product.
- Improper installation, delivery or maintenance.
- Failure of the product if it is abused, misused, or used for other than the intended purpose or used commercially.
- Replacement of house fuses or resetting of circuit breakers.
- Product not accessible to provide required service.
- Damage to the product caused by accident, fire, floods or acts of God.
- Incidental or consequential damage caused by possible defects with this appliance.
- Cleaning or servicing of the air gap device in the drain line.
- Damage caused after delivery, including damage from items dropped on the door.

EXCLUSION OF IMPLIED WARRANTIES—Your sole and exclusive remedy is product repair as provided in this Limited Warranty. Any implied warranties, including the implied warranties of merchantability or fitness for a particular purpose, are limited to one year or the shortest period allowed by law.

This warranty is extended to the original purchaser and any succeeding owner for products purchased for home use within the USA. If the product is located in an area where service by a GE Authorized Servicer is not available, you may be responsible for a trip charge or you may be required to bring the product to an Authorized GE Service location for service. Proof of original purchase date is needed to obtain service under the warranty. In Alaska, the warranty excludes the cost of shipping or service calls to your home.

Some states do not allow the exclusion or limitation of incidental or consequential damages. This warranty gives you specific legal rights, and you may also have other rights which vary from state to state. To know what your legal rights are, consult your local or state consumer affairs office or your state's Attorney General.

Warrantor: General Electric Company, Louisville, KY 40225

What Is Not Covered (for customers in Canada):

- Service trips to your home to teach you how to use the product.
- Improper installation.
If you have an installation problem, contact your dealer or installer. You are responsible for providing adequate electrical, exhausting and other connecting facilities.
- Failure of the product if it is abused, misused, or used for other than the intended purpose or used commercially.
- Replacement of house fuses or resetting of circuit breakers.
- Damage to the product caused by accident, fire, floods or acts of God.
- Damage caused after delivery.

EXCLUSION OF IMPLIED WARRANTIES—Your sole and exclusive remedy is product repair as provided in this Limited Warranty. Any implied warranties, including the implied warranties of merchantability or fitness for a particular purpose, are limited to one year or the shortest period allowed by law.

This warranty is extended to the original purchaser and any succeeding owner for products purchased in Canada for home use within Canada. In home warranty service will be provided in areas where it is available and deemed reasonable by Mabe to provide.

WARRANTOR IS NOT RESPONSIBLE FOR CONSEQUENTIAL DAMAGES.

Warrantor: MC Commercial, Burlington, ON, L7R 5B6

Notes.

Notes.

Notes.
