



Microwave Oven

Safety Instructions 2-8

Operating Instructions

Oven Features..... 9

Controls..... 10

Time Features 11-12

Defrost Features..... 13

Menu Features 14

Sensor Features..... 15-17

More modes Features 18

Power Levels..... 19

Other Features 20-21

Care and Cleaning..... 22-23

Replacing the Light Bulb..... 24

Exhaust Features..... 24

Troubleshooting Tips

Before you call for service..... 26

Consumer Support

Optional Kits..... 8

Product Registration..... 27

Warranty 29

Consumer Support..... 30

Owner's Manual

PVM2155

Write the model and serial numbers here:

Model # _____

Serial # _____

You can find them on a label when the door is open.

IMPORTANT SAFETY INSTRUCTIONS. READ ALL INSTRUCTIONS BEFORE USING.

When using electrical appliances basic safety precautions should be followed, including the following:

⚠ WARNING!

To reduce the risk of burns, electric shock, fire, injury to persons or exposure to excessive microwave energy:

PRECAUTIONS TO AVOID POSSIBLE EXPOSURE TO EXCESSIVE MICROWAVE ENERGY

- (a) **Do Not Attempt** to operate this oven with the door open since open-door operation can result in harmful exposure to microwave energy. It is important not to defeat or tamper with the safety interlocks.
- (b) **Do Not Place** any object between the oven front face and the door or allow soil or cleaner residue to accumulate on sealing surfaces.
- (c) **Do Not Operate** the oven if it is damaged. It is particularly important that the oven door close properly and that there is no damage to the:
 - (1) door (bent)
 - (2) hinges and latches (broken or loosened)
 - (3) door seals and sealing surfaces
- (d) **The Oven Should Not** be adjusted or repaired by anyone except properly qualified service personnel.

- **Read all instructions before using this appliance.**
- Read and follow the specific precautions in the PRECAUTIONS TO AVOID POSSIBLE EXPOSURE TO EXCESSIVE MICROWAVE ENERGY Section above.
- This appliance must be grounded. Connect only to a properly grounded outlet. See the GROUNDING INSTRUCTIONS section on page 7.
- This microwave oven is UL listed for installation over both gas (less than 60,000BTU) and electric ranges.
- This over-the-range oven is designed for use over ranges no wider than 36" (91.4 cm). It may be installed over both gas and electric cooking equipment.
- Do not operate this appliance if it has a damaged power cord or plug, if it is not working properly, or if it has been damaged or dropped. If the power cord is damaged, it must be replaced by General Electric Service or an authorized service agent using a power cord available from General Electric.
- Install or locate this appliance only in accordance with the provided installation instructions.
- Do not clean with metal scouring pads. Pieces can burn off the pad and touch electrical parts involving risk of electric shock.

Use this appliance only for its intended purpose as described in this Owner's Manual.

- To reduce the risk of fire in the oven cavity:
 - Do not overcook food. Carefully attend appliance when paper, plastic or other combustible materials are placed inside the oven while cooking.
 - Remove wire twist-ties and metal handles from paper or plastic containers before placing them in the oven.
 - Do not use the oven for storage purposes. Do not leave paper products, cooking utensils or food in the oven when not in use.
 - Do not pop popcorn in your microwave oven unless in a special microwave popcorn accessory or unless you use popcorn labeled for use in microwave ovens.
 - If materials inside the oven ignite, keep the oven door closed, turn the oven off and disconnect the power cord, or shut off power at the fuse or circuit breaker panel. If the door is opened, the fire may spread.
 - Do not use the oven to dry newspaper.
- **Thermometer**—Do not use regular cooking or oven thermometers when cooking by microwave. The metal and mercury in these thermometers could cause **arcing** and possible damage to the oven. Do not use a thermometer in food you are microwaving unless the thermometer is designed or recommended for use in the microwave oven.
- Do not store any materials, other than our recommended accessories, in this oven when not in use.
- Do not store this appliance outdoors. Do not use this product near water—for example, in a wet basement, near a swimming pool, near a sink or in similar locations.
- Keep power cord away from heated surfaces.
- Do not immerse power cord or plug in water.
- Do not block or cover any openings on the appliance.
- This microwave is not approved or tested for marine use.
- Use this appliance only for its intended use as described in this manual.
- Do not use corrosive chemicals or vapors in this appliance.
- This microwave oven is specifically designed to heat, dry or cook food, and is not intended for laboratory or industrial use.
- Some products such as whole eggs and sealed containers—for example, closed jars—are able to explode and should not be heated in this microwave oven. Such use of the microwave oven could result in injury.
- It is important to keep the area clean where the door seals against the microwave. Use only mild, non-abrasive detergents applied with a clean sponge or soft cloth. Rinse well.
- This appliance must only be serviced by qualified service personnel. Contact nearest authorized service facility for examination, repair or adjustment.
- As with any appliance, close supervision is necessary when used by children.
- Do not store anything directly on top of the microwave oven surface when the microwave oven is in operation.
- Do not mount this appliance over a sink.
- Do not let the cord hang over edge of counter.
- Do not use paper products in oven when appliance is operated in any cooking mode except microwave only.

SAVE THESE INSTRUCTIONS

IMPORTANT SAFETY INSTRUCTIONS. READ ALL INSTRUCTIONS BEFORE USING.



⚠ WARNING! **ARCING**

*If you see arcing, press the **CLEAR/OFF** button and correct the problem.*

Arcing is the microwave term for sparks in the oven. Arcing is caused by:

- Metal or foil touching the side of the oven.
- Turntable ring support not installed correctly.
- Foil not molded to food (upturned edges act like antennas).
- Metal, such as twist-ties, poultry pins, or gold-rimmed dishes, in the microwave.
- Recycled paper towels containing small metal pieces being used in the microwave.



⚠ WARNING! FOOD

- Do not pop popcorn in your microwave oven unless in a special microwave popcorn accessory or unless you use popcorn labeled for use in microwave ovens.
 - Do not boil eggs in a microwave oven. Pressure will build up inside egg yolk and will cause it to burst, possibly resulting in injury.
 - Operating the microwave with no food inside for more than a minute or two may cause damage to the oven and could start a fire. It increases the heat around the magnetron and can shorten the life of the oven.
 - Foods with unbroken outer “skin” such as potatoes, hot dogs, sausages, tomatoes, apples, chicken livers and other giblets, and egg yolks should be pierced to allow steam to escape during cooking.
 - **SUPERHEATED WATER**
Liquids, such as water, coffee, or tea, are able to be overheated beyond the boiling point without appearing to be boiling. Visible bubbling or boiling when the container is removed from the microwave oven is not always present. THIS COULD RESULT IN VERY HOT LIQUIDS SUDDENLY BOILING OVER WHEN THE CONTAINER IS DISTURBED OR A SPOON OR OTHER UTENSIL IS INSERTED INTO THE LIQUID.
- To reduce the risk of injury to persons:
- Do not overheat the liquid.
 - Stir the liquid both before and halfway through heating it.
 - Do not use straight-sided containers with narrow necks.
 - After heating, allow the container to stand in the microwave oven for a short time before removing the container.
 - Use extreme care when inserting a spoon or other utensil into the container.
- Foods cooked in liquids (such as pasta) may tend to boil more rapidly than foods containing less moisture. Should this occur, refer to the Care and Cleaning of the Microwave Oven section for instructions on how to clean the inside of the oven.
 - Avoid heating baby food in glass jars, even with the lid off. Make sure all infant food is thoroughly cooked. Stir food to distribute the heat evenly. Be careful to prevent scalding when warming formula. The container may feel cooler than the formula really is. Always test the formula before feeding the baby.
 - Don’t defrost frozen beverages in narrow-necked bottles (especially carbonated beverages). Even if the container is opened, pressure can build up. This can cause the container to burst, possibly resulting in injury.
 - Hot foods and steam can cause burns. Be careful when opening any containers of hot food, including popcorn bags, cooking pouches and boxes. To prevent possible injury, direct steam away from hands and face.
 - Do not overcook potatoes. They could dehydrate and catch fire, causing damage to your oven.
 - Cook meat and poultry thoroughly—meat to at least an INTERNAL temperature of 160°F (71°C) and poultry to at least an INTERNAL temperature of 180°F (82°C). Cooking to these temperatures usually protects against foodborne illness.

SAVE THESE INSTRUCTIONS

IMPORTANT SAFETY INSTRUCTIONS.

READ ALL INSTRUCTIONS BEFORE USING.



MICROWAVE-SAFE COOKWARE

Do not operate the oven in the microwave mode without the turntable and the turntable support seated and in place. The turntable must be unrestricted so it can rotate. *Make sure all cookware used in your microwave oven is suitable for microwaving. Most glass casseroles, cooking dishes, measuring cups, custard cups, pottery or china dinnerware which does not have metallic trim or glaze with a metallic sheen can be used. Some cookware is labeled "suitable for microwaving."*

- If you are not sure if a dish is microwave-safe, use this test: Place in the oven both the dish you are testing and a glass measuring cup filled with 1 cup (240 mL) of water—set the measuring cup either in or next to the dish. Microwave 30–45 seconds at high. If the dish heats, it should not be used for microwaving. If the dish remains cool and only the water in the cup heats, then the dish is microwave-safe.
- Oversized food or oversized metal cookware should not be used in a microwave/convection oven because they increase the risk of electric shock and could cause a fire.
- Sometimes the oven floor, turntable and walls can become too hot to touch. Be careful touching the floor, turntable and walls during and after cooking.
- If you use a meat thermometer while microwaving, make sure it is safe for use in microwave ovens.
- Do not use recycled paper products. Recycled paper towels, napkins and waxed paper can contain metal flecks which may cause arcing or ignite. Paper products containing nylon or nylon filaments should be avoided, as they may also ignite.



How to test for a microwave-safe dish.

- Some foam trays (like those that meat is packaged on) have a thin strip of metal embedded in the bottom. When microwaved, the metal can burn the floor of the oven or ignite a paper towel.
- Do not use your microwave oven to dry newspapers.
- Not all plastic wrap is suitable for use in microwave ovens. Check the package for proper use.
- Paper towels, waxed paper and plastic wrap can be used to cover dishes in order to retain moisture and prevent spattering while microwaving. Be sure to vent plastic wrap so steam can escape.
- Cookware may become hot because of heat transferred from the heated food. Pot holders may be needed to handle the cookware.
- When microwaving "boilable" cooking pouches and tightly closed plastic bags, they should be slit, pierced or vented as directed by package. If they are not, plastic could burst during or immediately after cooking, possibly resulting in injury. Also, plastic storage containers should be at least partially uncovered because they form a tight seal. When cooking with containers tightly covered with plastic wrap, remove covering carefully and direct steam away from hands and face.



MICROWAVE-SAFE COOKWARE (cont.)

- Use foil only as directed in this manual. When using foil in the microwave oven, keep the foil at least 1" (2.5 cm) away from the sides of the oven.
- Plastic cookware designed for microwave cooking is very useful, but should be used carefully. Even microwave-safe plastic may not be as tolerant of overcooking conditions as are glass or ceramic materials and may soften or char if subjected to short periods of overcooking. In longer exposures to overcooking, the food and cookware could ignite.

Follow these guidelines:

- 1** Use microwave-safe plastics only and use them in strict compliance with the cookware manufacturer's recommendations.
- 2** Do not microwave empty containers.
- 3** Do not permit children to use plastic cookware without complete supervision.

GROUNDING INSTRUCTIONS

⚠ WARNING!

Improper use of the grounding can result in a risk of electric shock.

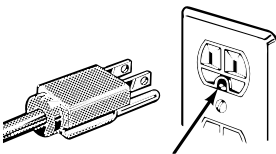

Ensure proper ground exists before use.

This appliance must be grounded. In the event of an electrical short circuit, grounding reduces the risk of electric shock by providing an

escape wire for the electric current.

This appliance is equipped with a power cord having a grounding wire with a grounding plug. The plug must be plugged into an outlet that is properly installed and grounded.

Consult a qualified electrician or service technician if the grounding instructions are not completely understood, or if doubt exists as to whether the appliance is properly grounded.

If the outlet is a standard 2-prong wall outlet, it is your personal responsibility and obligation to have it replaced with a properly grounded 3-prong wall outlet.

Do not under any circumstances cut or remove the third (ground) prong from the power cord.

Do not use an adapter plug with this appliance.

Do not use an extension cord with this appliance. If the power cord is too short, have a qualified electrician or service technician install an outlet near the appliance.

For best operation, plug this appliance into its own electrical outlet to prevent flickering of lights, blowing of fuse or tripping of circuit breaker.

SAVE THESE INSTRUCTIONS

IMPORTANT SAFETY INSTRUCTIONS. READ ALL INSTRUCTIONS BEFORE USING.

THE VENT FAN

The fan will operate automatically under certain conditions (see automatic Fan feature). Take care to prevent the starting and spreading of accidental cooking fires while the vent fan is in use.

- ④ Clean the underside of the microwave often. Do not allow grease to build up on the microwave or the fan filters.
- ④ In the event of a grease fire on the surface units below the microwave oven, smother a flaming pan on the surface unit by covering the pan completely with a lid, a cookie sheet or a flat tray.

- ④ Use care when cleaning the vent fan filters. Corrosive cleaning agents, such as lye-based oven cleaners, may damage the filters.
- ④ When preparing flaming foods under the microwave, turn the fan on.
- ④ Never leave surface units beneath your microwave oven unattended at high heat settings. Boilovers cause smoking and greasy spillovers that may ignite and spread if the microwave vent fan is operating. To minimize automatic fan operation, use adequate sized cookware and use high heat on surface units only when necessary.

PACEMAKERS

Most pacemakers are shielded from interference from electronic products, including microwaves. However, patients with pacemakers may wish to consult their physicians if they have concerns.

READ AND FOLLOW THIS SAFETY INFORMATION CAREFULLY.

SAVE THESE INSTRUCTIONS

About the features of your oven.

GEAppliances.ca

Throughout this manual, features and appearance may vary from your model.

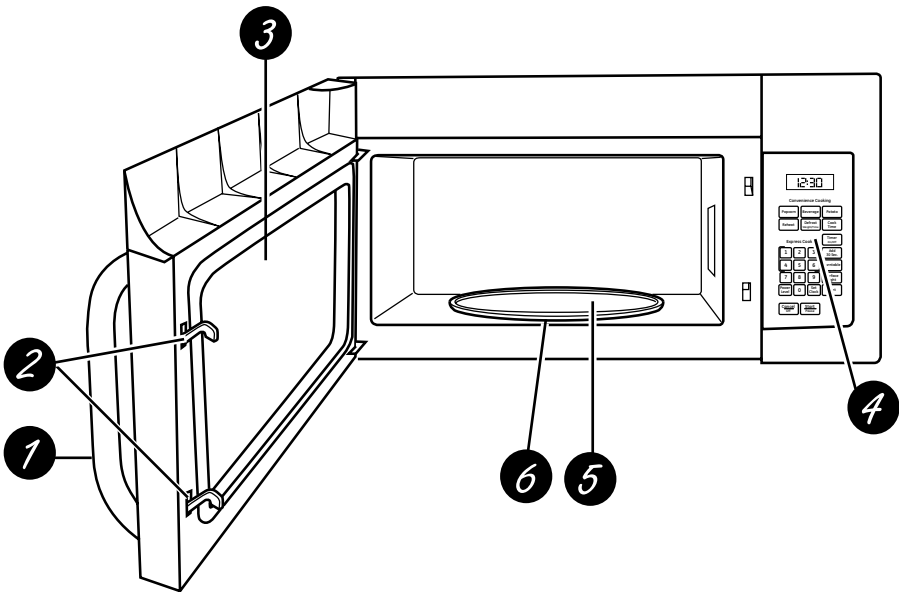

Features of the Oven

- 1 Door Handle.**
- 2 Door Latches.**
- 3 Window with Metal Shield.** Screen allows cooking to be viewed while keeping microwaves confined in the oven.
- 4 Control Panel.**
- 5 Removable Turntable.** Do not operate the oven in the microwave mode without the turntable and turntable support seated and in place.
- 6 Removable Turntable Support.** Do not operate the oven in the microwave mode without the turntable and turntable support seated and in place.

About the cooking features of your microwave oven.

Throughout this manual, features and appearance may vary from your model.

Control Panel

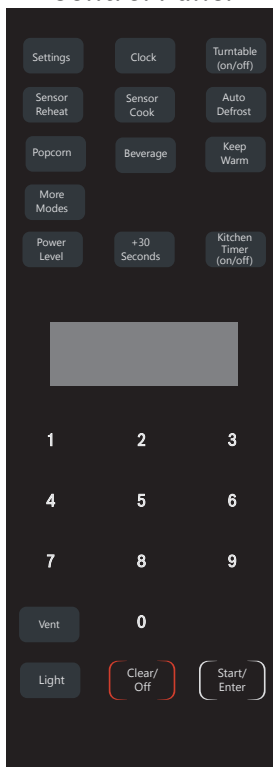

Press button	Function
Settings	Change basic settings
Clock	Set time of day
Turntable (on/off)	Switches turntable on or off
Sensor Reheat	Reheat food with automatic settings
Sensor Cook	Cook food with automatic settings
Auto Defrost	Defrost food with automatic settings
Popcorn	Select popcorn bag size
Beverage	Heat beverages, select beverage size
Keep Warm	Set Keep Warm feature
More Modes	Enter more modes for convenience cooking
Power Level	Set power level for microwave operation
+ 30 Seconds	Add 30 seconds to microwave timer

Press button	Function
Kitchen Timer	Set kitchen timer
0 - 9	Use the number keys to enter customized values
Vent	Turn kitchen ventilation feature on/off
Light	Turn surface light on/off
Clear/Off	Clear entered value/turn appliance off
Start/Enter	Confirm input, Start operation

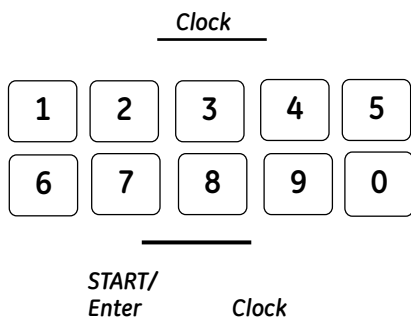

Clock Setting

Allows you to set the clock in 12 hour mode.

- 1 Press **CLOCK**.
- 2 Press the number keys to set the current time.
- 3 Press **START or Clock** to confirm the clock.

+ 30
Seconds

Express Cook

This is a quick way to set cooking time for 30 seconds.

- 1 Press on + **30 Seconds** pads once for cooking at **power level 10**.
For example, press the + **30 Seconds** four times for 2 minutes of cooking time.
Each press on the same button can increase 30s.
Allows you to microwave for any time up to 99 minutes and 59 seconds.

+ 30
Seconds

Add 30 Sec

This will add 30 seconds to the time counting down each time the pad is pressed. Each touch will add 30 seconds, up to 99 minutes and 59 seconds.

Add 30 sec can also be used like an express 30 seconds button. The microwave oven will start immediately when pressed.

About the time features.

**Kitchen
Timer
(on/off)**

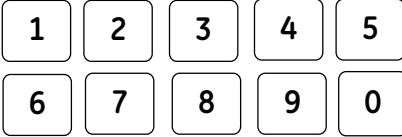

**Kitchen
Timer
(on/off)**

**START/
Enter**

Kitchen Timer

Allows you to set the time up to 99 minutes and 99 seconds.

- 1** Press **KITCHEN TIMER**.
- 2** Press the number keys to set the timer.
- 3** Press **START or KITCHEN TIMER** to confirm the setting.

The kitchen timer will count down.

AUTO DEFROST

Express Cook _____

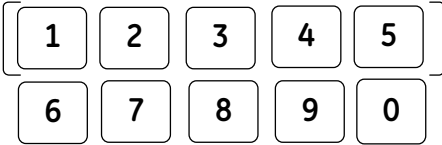

START/
Enter

Weight Defrost

Use **Weight Defrost** for ground meat, meat pieces and poultry pieces.

(Weight Defrost is from 0.5 lbs to 3 lbs.)

(dEF1 for ground meat; dEF2 for meat pieces; dEF3 for poultry pieces.)

- 1** Press **AUTO DEFROST** once or several times for **Weight Defrost**.
- 2** Press **START** to confirm the function.
- 3** Enter the weight in pounds.
- 4** Press **START**.
Cooking will start when the countdown begins in the display.

Defrosting Tips

- Remove meat from package and place on microwave-safe dish.
- When the oven signals, turn the food over. Remove defrosted meat or shield warm areas with small pieces of foil.
- After defrosting, most meats need to stand 5 minutes to complete defrosting. Large roasts should stand for about 30 minutes.

Conversion Guide

if the weight of food is stated in pounds and ounces, the ounces must be converted to tenths (.1) of a pound.

Ounces	Pounds
1-2 (28-57 g)	.1
3 (85 g)	.2
4-5 (113-142 g)	.3
6-7 (170-198 g)	.4
8 (227 g)	.5
9-10 (255 g)	.6
11 (312 g)	.7
12-13 (340-369 g)	.8
14-15 (397-425 g)	.9

Note: Max 3.0 lbs. (1.35 kg)

About the menu features.

POPCORN

**START/
Enter**

Popcorn

To use the Popcorn feature:

- 1** Place the package of popcorn in the center of the microwave.
- 2** Press **POPCORN** repeatedly to select the weight.
- 3** Press **START**.

Your popcorn bag may get stuck and stop rotating, but this will not affect the cooking performance. Do not open the door even if the bag is not rotating.

BEVERAGE

**START/
Enter**

Beverage

To use the **BEVERAGE** feature:

- 1** Place the beverage container in the center of the microwave.
- 2** Press **BEVERAGE** repeatedly to select the weight.
- 3** Press **START**.

KEEP WARM

**START/
Enter**

Keep Warm

To use the **KEEP WARM** feature:

- 1** Press **KEEP WARM**.
- 2** Press the number keys to set the warm time.
- 3** Press **START**.

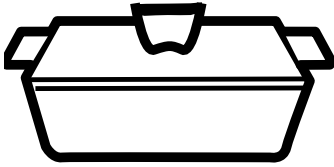

Covered

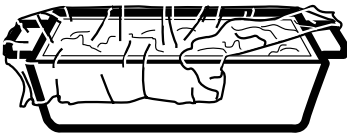

Vented

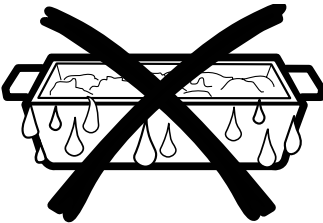

Dry off dishes so they don't mislead the sensor.

The Sensor Features detect the increasing humidity released during cooking. The oven automatically adjust the cooking time to various types and amounts of food.

Do not use the Sensor Features twice in succession on the same food portion - it may result in severely overcooked or burnt food. Be sure to let the oven cool down for 5 - 10 minutes before starting the next sensor cook.

- The proper containers and covers are essential for best sensor cooking.
- **Always use microwave-safe containers and cover them with lids or vented plastic wrap. Never use tight-sealing plastic covers - they can prevent steam from escaping and cause food to overcook.**
- **Be sure the outside of the cooking container and the inside of the microwave oven are dry** before placing food in the oven. Beads of moisture turning into steam can mislead the sensor.

About the sensor features.

Sensor Reheat

START/
Enter

Sensor Reheat

Allows you to microwave food choices with sensor.

- 1** Press **SENSOR REHEAT** button.
- 2** Press **SENSOR REHEAT** button to select the menu you desire.
- 3** Press **START**.

Sensor Reheat programs

Program no.	Food	Quantity
Sr-1	Dinner plate	8 to 16 oz. (227 to 454 g)
Sr-2	Casserole, pasta	2 to 4 cups (480 to 960 mL)

Sensor Cook

START/
Enter

Sensor Cook

Allows you to microwave food choices with sensor.

- 1 Press **SENSOR COOK** button.
- 2 Press **SENSOR COOK** button to select the menu you desire.
- 3 Press **START**.

Sensor Cook programs

Display	Food	Quantity
Sc-1	Baked Potato	1 - 4 potatoes
Sc-2	Sweet Potato	1 - 4 potatoes
Sc-3	Fresh Vegetable	8 - 24 oz (227 - 680 g)
Sc-4	Frozen Vegetable	8 - 24 oz (227 - 680 g)
Sc-5	Ground Meat	8 - 24 oz (227 - 680 g)
Sc-6	Fish/Seafood	8 - 24 oz (227 - 680 g)
Sc-7	Brown Rice	1 - 2 cups (240 - 480 mL)
Sc-8	White Rice	1 - 2 cups (240 - 480 mL)
Sc-9	Frozen Entrees	8 - 24 oz (227 - 680 g)

About the sensor features.

More Modes

START/ Enter

More modes

Allows you to microwave food choices with sensor.

- 1 Press **MORE MODES** button.
- 2 Press **MORE MODES** button to select the menu you desire,
- 3 Press **START**.

For modes 1 to 4; press number keys to enter the desired weight category; For modes 5(time defrost): "00:00" is blinking, then press number keys to enter the desired defrost time.

- 4 Press **START**.

Note: Time Defrost consists of 2 stages. When one stage is finished, 5 beeps will sound.

Available modes

Mode no.	Name	Input
1	Melt butter	1=2 tablespoons 2 = 1/4 cup (60 mL) 3 = 1/2 cup (120 mL) 4 = 1 cup (240 mL)
2	Melt chocolate	1=1 cup (240 mL) 2=2 cups (480 mL)
3	Soften ice cream	1=4 oz. (113 mL) 2=8 oz. (227 mL) 3=16 oz. (454 mL) 4=32 oz. (908 mL) 5=48 oz. (1.3 L)
4	Soften cream cheese	1=3 oz. (85 mL) 2=6 oz. (170 mL) 3=8 oz. (227 mL)
5	Time defrost	Enter defrost time

About the power level features.

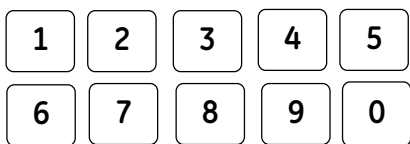

**Power
Level**

**START/
Enter**

Changing the Power Level

The power level may be entered or changed before or during cooking. **Power Level** is set for Level 10 (High) unless it is changed.

- 1** Press the number keys to set the cooking time.
- 2** Press **POWER LEVEL** to adjust the power level.
- 3** Press **START**.

Variable power levels add flexibility to microwave cooking. The power levels on the microwave oven can be compared to the surface units on a range. Each power level gives you microwave energy a certain percent of the time. **Power level 7** is microwave energy 70% of the time. **Power level 3** is energy 30% of the time. Most cooking will be done on High (power level 10) which gives you 100% power. **Power level 10** will cook faster but food may need more frequent stirring, rotating or turning over. A lower setting will cook more evenly and needs less stirring or rotating of the food. Some foods may have better flavor, texture or appearance if one of the lower settings is used. Use a lower power level when cooking foods that have a tendency to boil over, such as scalloped potatoes and some casseroles.

Rest periods (when the microwave energy cycles off) give time for the food to “equalize” or transfer heat to the inside of the food. An example of this is shown with **Power level 3**—the defrost cycle. If microwave energy did not cycle off, the outside of the food would cook before the inside was defrosted.

Here are some examples of uses for various power levels:

High 10 (100%): Fish, bacon, vegetables, boiling liquids.

Med-High 7 (70%): Gentle cooking of meat and poultry; baking casseroles and reheating.

Medium 5 (50%): Slow cooking and tenderizing for stews and less tender cuts of meat.

Low 2 or 3 (20 or 30%): Defrosting; simmering; delicate sauces.

Warm 1 (10%): Keeping food warm; softening butter.

NOTE: You can also change the power level during many cooking modes by pressing the power level button entering a valid power level.

About the other features.

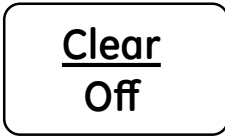

Clear/Off

Press the **CLEAR/OFF** button to stop and cancel cooking at any time.

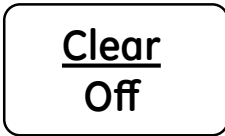

Control Lock-Out

You may lock the control panel to prevent the oven from being accidentally started during cleaning or being used by children.

To lock or unlock the controls, press and hold the **CLEAR/OFF** button for three seconds. When the control panel is locked, "" will show in the display.



Surface Light

Press **LIGHT** once for high light, twice for low light or a third time to turn the light off.

Note: If the microwave is working and the vent fan is on Boost speed, the surface lights will be turned to low light automatically.



Turntable

For best cooking results, leave the turntable on. it can be turned off for large dishes.

Press the **TURNTABLE** pad once to turn the turntable off. Press again to turn the turntable back on.

Sometimes the turntable can become too hot to touch. Be careful touching the turntable during and after cooking.

Settings

Settings

Settings allow to change the default settings of your OTR.

- 1** Press the Settings pad. "SELECT SETTING ITEM
1 - BEEPER VOLUME, 2 - CLOCK MODE.
- 2** Select the item to change the settings. See below tables for detail Guide
- 3** Press **START**.

Code Entry	Items for setting	Level Entry
1	Beeper Volume	1 - ON 2 - OFF
2	Clock Mode	1 - ON 2 - OFF

Vent

Vent Fan

The vent fan removes steam and other vapors from surface cooking.

Press **VENT** to select vent speed.

Display	Vent level
4 HI	4 (high)
3	3
2	2
1 LO	1 (low)
OFF	OFF

Automatic Fan

An automatic fan feature protects the microwave from too much heat rising from the cooktop below it. It automatically turns on if it senses too much heat.

If you have turned the fan on you may find that you cannot turn it off. The fan will automatically turn off when the internal parts are cool. It may stay on for 30 minutes or more after the cooktop and microwave controls are turned off.

Care and cleaning of the oven.



Helpful Hints

An occasional thorough wiping with a solution of baking soda and water keeps the inside fresh.

Be sure the power is off before cleaning any part of this microwave oven.

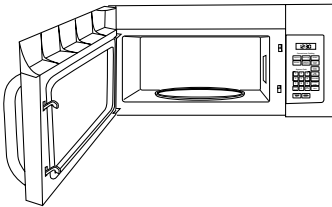

How to Clean the Inside

Walls, Floor, Inside Window, Metal and Plastic Parts on the Door

Some spatters can be removed with a paper towel; others may require a damp cloth. Remove greasy spatters with a sudsy cloth, then rinse with a damp cloth. Do not use abrasive cleaners or sharp utensils on oven walls.

Never use a commercial oven cleaner on any part of your microwave.

Removable Turntable and Turntable Support

To prevent breakage, do not place the turntable into water just after cooking. Wash it carefully in warm, sudsy water or in the dishwasher. The turntable and support can be broken if dropped. Remember, do not operate the oven in the microwave mode without the turntable and support seated and in place.

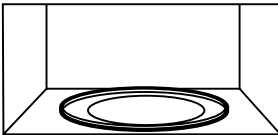

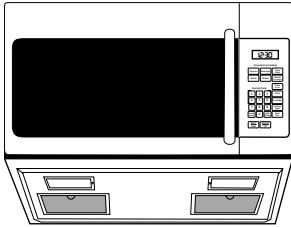
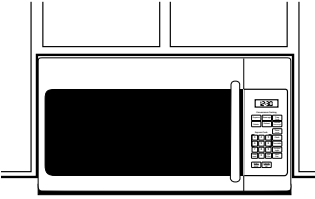

Control Panel

Wipe with a damp cloth. Dry thoroughly. Do not use cleaning sprays, large amounts of soap and water, abrasives or sharp objects on the panel—they can damage it. Some paper towels can also scratch the control panel.

Door Panel

Before cleaning the front door panel, make sure you know what type of panel you have. Refer to the eighth digit of the model number. "S" is stainless steel "B", "W" or "C" are plastic colors.

Stainless Steel (on some models)

The stainless steel panel can be cleaned with Stainless Steel Magic or a similar product using a clean, soft cloth. Apply stainless cleaner carefully to avoid the surrounding plastic parts. Do not use appliance wax, polish, bleach or products containing chlorine on Stainless Steel finishes.

Plastic Color Panels

Use a clean, soft, lightly dampened cloth, then dry thoroughly.

Door Seal

It's important to keep the area clean where the door seals against the microwave. Use only mild, non-abrasive detergents applied with a clean sponge or soft cloth. Rinse well.

Bottom

Clean off the grease and dust on the bottom often. Use a solution of warm water and detergent.

How to Clean the Outside

We recommend against the use of spray cleaners and using cleaners with ammonia or alcohol, as they can damage the appearance of the microwave oven. If you choose to use a common household cleaner, first apply the cleaner directly to a clean cloth, then wipe the soiled area.

Case

Clean the outside of the microwave with a sudsy cloth. Rinse and then dry. Wipe the window clean with a damp cloth.

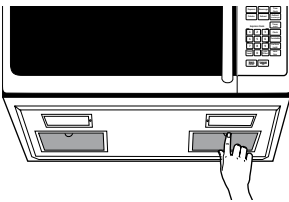

Removing and Cleaning the Filters

To remove, slide them to the rear using the tabs. Pull down and out.

To clean the vent filters, soak them and then swish around in hot water and detergent. Don't use ammonia or ammonia products because they will darken the metal. Light brushing can be used to remove embedded dirt.

Rinse, shake and let dry before replacing.

To replace, slide the filters into the frame slots on the back of each opening. Press up and to the front to lock into place.

Replacing the light bulb.

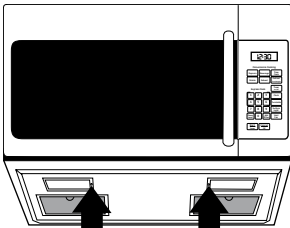

Remove screws.

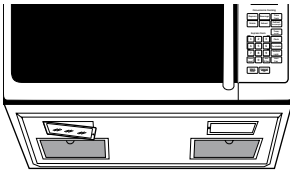

Cooktop Lights/Nite Lights

Replace with 120 volt, 30 watt (max) incandescent bulbs.

- 1** To replace the cooktop lights/nite lights, first disconnect the power at the main fuse or circuit breaker panel, or pull the plug.
- 2** One side at a time, remove the screw from the side of the light compartment cover and lower the cover until it stops.
- 3** Be sure the bulb is cool before removing. Break the adhesive seal by gently unscrewing the bulb.
- 4** Screw in the new bulb, then raise the light cover and replace the screw. Repeat for the other light. Connect electrical power to the oven.

Replacing the Oven Cavity Lamp

1. Disconnect power at the main fuse or circuit breaker panel.
2. Remove the top grill by removing the two screws that hold it in place.
3. Remove charcoal filter if present. **NOTE:** Charcoal filter is an optional kit, you may not have one.
4. Press the retainer holding the lamp shield in place.
5. Pull the lamp shield out. Unscrew the light bulb out and replace with the 120V-130V, 30W incandescent bulb.
6. Return the lamp and lamp shield to original position and replace charcoal filter.
7. Replace the grill and 2 screws. Reconnect power to the oven.

About the exhaust feature.

Charcoal filter (on some models).

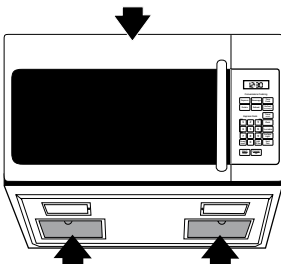

Reusable vent filters
(on all models).

Vent Fan

The vent fan has two metal reusable vent filters. Models that recirculate air back into the room also use a charcoal filter.

Reusable Vent Filters

The metal filters trap grease released by foods on the cooktop. They also prevent flames from foods on the cooktop from damaging the inside of the oven.

For this reason, the filters must always be in place when the hood is used. The vent filters should be cleaned once a month, or as needed.

Things That Are Normal With Your Microwave Oven

- Moisture on the oven door and walls while cooking. Wipe the moisture off with a paper towel or soft cloth.
- Moisture between the oven door panels when cooking certain foods. Moisture should dissipate shortly after cooking is finished.
- Steam or vapor escaping from around the door.
- Light reflection around door or outer case.
- Dimming oven light and change in the blower sound at power levels other than high.
- Noises while oven is operating.
- TV-radio interference might be noticed while using the microwave. Similar to the interference caused by other small appliances, it does not indicate a problem with the microwave. Plug the microwave into a different electrical circuit, move the radio or TV as far away from the microwave as possible or check the position and signal of the TV/radio antenna.

Before you call for service....



Troubleshooting Tips

Save time and money! Review the charts on the following pages first and you may not need to call for service.

Problem	Possible Cause	What To Do
Oven will not start	A fuse in your home may be blown or the circuit breaker tripped.	<ul style="list-style-type: none"> • Replace fuse or reset circuit breaker.
	Power surge.	<ul style="list-style-type: none"> • Unplug the microwave oven, then plug it back in.
	Plug not fully inserted into wall outlet	<ul style="list-style-type: none"> • Make sure the 3-prong plug on the oven is fully inserted into wall outlet.
	Door not securely closed.	<ul style="list-style-type: none"> • Open the door and close securely.
Control panel lighted, yet oven will not start	Door not securely closed.	<ul style="list-style-type: none"> • Open the door and close securely.
	START/ENTER button not pressed after entering cooking selection.	<ul style="list-style-type: none"> • Press START/ENTER.
	Another selection entered already in oven and CLEAR/OFF button not pressed to cancel it.	<ul style="list-style-type: none"> • Press CLEAR/OFF.
	CLEAR/OFF was pressed accidentally.	<ul style="list-style-type: none"> • Reset cooking program and press START/ENTER.
CONTROL LOCKED appears on display	The control has been locked.	<ul style="list-style-type: none"> • Press and hold CLEAR/OFF for about 3 seconds to unlock the control.
Floor of the oven is warm even when the oven has not been used	The cooktop light is located below the oven floor. When light is on, the heat it produces may make the oven floor get warm.	<ul style="list-style-type: none"> • This is normal.
You hear an unusual low-tone beep	You have tried to change the power level when it is not allowed.	<ul style="list-style-type: none"> • Many of the oven's features are preset and cannot be changed.
Vent fan comes on automatically	The vent fan automatically turns on to protect the microwave if it senses too much heat rising from the cooktop below.	<ul style="list-style-type: none"> • This is normal.

Please place in envelope and mail to:
Veuillez mettre dans une enveloppe et envoyez à :

**OWNERSHIP REGISTRATION
P.O. BOX 1780
MISSISSAUGA, ONTARIO
L4Y 4G1
(FOR CANADIAN CONSUMERS ONLY -
POUR RÉSIDENTS CANADIENS SEULEMENT)**



For Canadian
Customers



Pour les
consommateurs
canadiens

CUT ALONG THIS LINE AND RETURN CARD - THANKS
DÉCOUPEZ ICI ET ENVOYEZ LA FICHE - MERCI

OWNERSHIP REGISTRATION CERTIFICATE - FICHE D'ESCRPTION DU PROPRIÉTAIRE

Please register your product to enable us to contact you in the remote event a safety notice is issued for this product and to allow for efficient communication under the terms of our warranty, should the need arise.

Veuillez enregistrer votre produit afin de nous permettre de communiquer avec vous si jamais un avis de sécurité concernant ce produit était émis et de communiquer facilement avec vous en vertu de votre garantie, si le besoin s'en fait sentir.

REGISTER ON-LINE: ENREGISTRER EN LIGNE		MAIL TO: P.O. BOX 1780, MISSISSAUGA POSTEZA: ONTARIO, L4Y 4G1	
www.geappliances.ca www.electromenagersge.ca			
<input type="checkbox"/> MR./M. <input type="checkbox"/> MISS/MILLE	<input type="checkbox"/> MRS./MME <input type="checkbox"/> MS.	FIRST NAME / PRENOM	LAST NAME / NOM
STREET NO / N° RUE		STREET NAME / RUE	
CITY / VILLE		PROVINCE	POSTAL CODE / CODE POSTAL
AREA CODE / IND. REG.	TELEPHONE / TÉLÉPHONE	E-MAIL / COURRIEL	
DID YOU PURCHASE A SERVICE CONTRACT FOR THIS APPLIANCE? AVEZ-VOUS ACHETÉ UN CONTRAT DE SERVICE POUR CET APPAREIL ?		YES / OUI <input type="checkbox"/>	IF YES / SI OUI : EXPIRATION DU M M DU
NAME OF SELLING DEALER / NOM DU MARCHAND		MODEL / MODÈLE	
INSTALLATION DATE / DATE D'INSTALLATION Y/A M DU		CORRESPONDENCE CORRESPONDANCE	
		<input type="checkbox"/> ENGLISH <input type="checkbox"/> FRANÇAIS	
		SERIAL / SÉRIE	

I do not wish to receive any promotional offers regarding this product.
Je ne désire pas recevoir d'offres promotionnelles concernant ce produit.

GE Microwave Oven Warranty

GEAppliances.ca



All warranty service provided by our Factory Service Centers, or an authorized Customer Care® technician. To schedule service, online, contact us at GEAppliances.ca, or call 1.800.561.3344. Please have serial and model numbers available when calling for service.

Staple your receipt here. Proof of the original purchase date is needed to obtain service under the warranty.

For The Period Of:	MC Commercial Inc. Will Choose to Replace or Service:
One Year From the date of original purchase	In the event of service, MC Commercial Inc. will provide any part of the microwave oven which fails due to a defect in materials or workmanship. During this limited one-year warranty , MC Commercial Inc. will also provide, free of charge , all labor and related service costs to replace the defective part when the unit is serviced.
Five Year From the date of original purchase	MC Commercial Inc. will choose to either replace the unit or replace the magnetron tube , if the magnetron tube fails due to a defect in materials or workmanship. During this five -year limited warranty , you will be responsible for any labor or in-home service cost.

What MC Commercial Inc. Will Not Cover:

- Service trips to your home to teach you how to use the product.
- Improper installation, delivery or maintenance.
- If you have an installation problem, contact your dealer or installer. You are responsible for providing adequate electrical, exhausting, and other connecting facilities.
- Failure of the product or damage to the product if it is abused, misused (for example, cavity arcing from wire rack or metal/foil), or used for other than the intended purpose or used commercially.
- Replacement of house fuses or resetting of circuit breakers.
- Damage to the product caused by accident, fire, floods or acts of God.
- Incidental or consequential damage caused by possible defects with this appliance.
- Damage caused after delivery.
- Product not accessible to provide required service.
- Service to repair or replace light bulbs, except for LED lamps.
- Damage to the finish, such as surface rust, tarnish, or small blemishes not reported within 48 hrs of delivery

EXCLUSION OF IMPLIED WARRANTIES—Your sole and exclusive remedy is product exchange as provided in this Limited Warranty. Any implied warranties, including the implied warranties of merchantability or fitness for a particular purpose, are limited to one year or the shortest period allowed by law.

This warranty is extended to the original purchaser and any succeeding owner for products purchased for home use within Canada. If the product is located in an area where service by a MC Commercial Inc. Authorized Servicer is not available, you may be responsible for a trip charge or you may be required to bring the product to an Authorized MC Commercial Inc. Service Location for service.

Some provinces do not allow the exclusion or limitation of incidental or consequential damages. This warranty gives you specific legal rights, and you may also have other rights which vary from province to province. To know what your legal rights are, consult your local or provincial consumer affairs office.

Warrantor: MC Commercial Inc., Burlington, Ontario L7R 5B6

Consumer Support.



GE Appliances Website

GEAppliances.ca

Have a question or need assistance with your appliance? Try the GE Appliances Website 24 hours a day, any day of the year! For greater convenience and faster service, you can now download Owner's Manuals, order parts, catalogs.



Schedule Service

GEAppliances.ca

Expert MC Commercial Inc. repair service is only one step away from your door. Get on-line and schedule your service at your convenience any day of the year! Or call 1.800.561.3344 during normal business hours.



Service Contracts

GEAppliances.ca

Purchase a MC Commercial Inc. extended warranty and learn about special discounts that are available while your warranty is still in effect. You can purchase it on-line anytime, or call 1.800.461.3636 during normal business hours. MC Commercial Inc. Consumer Home Services will still be there after your warranty expires.



Parts and Accessories

GEAppliances.ca

Individuals qualified to service their own appliances can have parts or accessories sent directly to their homes (VISA, MasterCard and Discover cards are accepted). Order on-line today, 24 hours every day or by phone at 1.800.661.1616 during normal business hours. **Instructions contained in this manual cover procedures to be performed by any user. Other servicing generally should be referred to qualified service personnel. Caution must be exercised, since improper servicing may cause unsafe operation.**



Contact Us

GEAppliances.ca

If you are not satisfied with the service you receive from MC Commercial Inc., contact us on our Website with all the details including your phone number, or write to:

Director, Customer Relations, MC Commercial Inc.
Suite 310, 1 Factory Lane,
Moncton NB E1C 9M3



Register Your Appliance

GEAppliances.ca

Register your new appliance on-line- at your convenience! Timely product registration will allow for enhanced communication and prompt service under the terms of your warranty, should the need arise. You may also mail in the pre-printed registration card included in the packing material.